

CULLMANN[®]

CUlight **FR 60N**

for Nikon



Foreword

Thank you for purchasing this product.

This CUlight FR 60N camera flash applies to Nikon DSLR series cameras and is compatible with i-TTL. With this i-TTLcompatible flash, your shooting will become simpler. You can easily achieve a correct flash exposure even in complex light-changing environments. This camera flash features:

- GN60 (m ISO 100, @200mm). 22 steps from 1/1 to 1/128.
- Fully support Nikon i-TTL camera flash. Workable as Master or Slave unit in a wireless flash group.
- Use dot-matrix LCD panel to make clear and convenient operations.
- With built-in 2.4GHz wireless remote system to support transmitting and receiving.
- Provided multiple functions, include HSS (up to 1/8000s), FEC, FEB, etc.
- Stable consistency and color temperature with good even lighting.
- Support with firmware upgrade.



For Your Safety

- ⚠ Always keep this product dry. Do not use in rain or in damp conditions.
- ⚠ This product contains high-voltage electronic parts. Touching the high-voltage circuit inside it may result in electric shock. Do not disassemble. Should repairs become necessary, this product must be sent to an authorized maintenance center.
- ⚠ Stop using this product if it breaks open due to extrusion, falling or strong hit. Otherwise, electric shock may occur if you touch the electronic parts inside it.
- ⚠ Do not fire the flash directly into the eyes (especially those of babies) within short distances. Otherwise visual impairment may occur. When taking pictures for babies, keep the flash unit at least 1 meter (3.3 feet) away from them. Using bounce flash to reduce light intensity is also recommended.
- ⚠ Do not use the flash unit in the presence of flammable gases, chemicals and other similar materials. In certain circumstances, these materials may be sensitive to the strong light emitting from this flash unit and fire or electromagnetic interference may result.
- ⚠ Do not leave or store the flash unit in places where the ambient temperature reads over 50°C (e.g. in automobile). Otherwise the electronic parts may be damaged.

Conventions used in this Manual

- This manual is based on the assumption that both the camera and camera flash's power switches are powered on.
- Reference page numbers are indicated by "p.**".
- The following alert symbols are used in this manual:
 - ▲ The Caution symbol gives supplemental information.
 - The Note symbol indicates a warning to prevent shooting problem.

Contents

Foreword	30
For Your Safety	31
Name of Parts	34
Body	34
Control Panel	34
LCD Panel	35
What's in the Box of CUlight FR 60N?	36
Separately Sold Accessories	36
Attaching to a Camera	37
Power Management	37
i-TTL Flash Mode	38
 FEC: Flash Exposure Compensation	38
 High-Speed Sync	39
 Second-Curtain Sync	39
M: Manual Flash	40
RPT: Stroboscopic Flash	41
Wireless Flash Shooting: Optic Transmission	42
1. Wireless Settings	43
2. Setting Master Unit's Flash Mode	43
3. Setting the Communication Channel	43
4. i-TTL Fully Automatic Wireless Flash Shooting	44
5. M: Wireless Flash Shooting with Manual Flash	45
6. RPT: Wireless Flash Shooting with Manual Flash	45
Wireless Flash Shooting:	46
Radio (2.4G) Transmission	46
Other Applications	47
Modelling Flash	48
Auto Focus Assist Beam	48
Bounce Flash	48
Creating a Catchlight	49
ZOOM: Setting the Flash Coverage and Using the Wide Panel	49
Using the Wide Panel	49
Low Battery Warning	50
Factory Settings	50
C.Fn: Setting Custom Functions	50
Protection Function	51
1. Over-Temperature Protection	51
2. Other Protections	51
Technical Data	52
Troubleshooting	53
Firmware Upgrade	54
Compatible Camera Models	54
Maintenance	54
Declaration of Conformity	54

Name of Parts

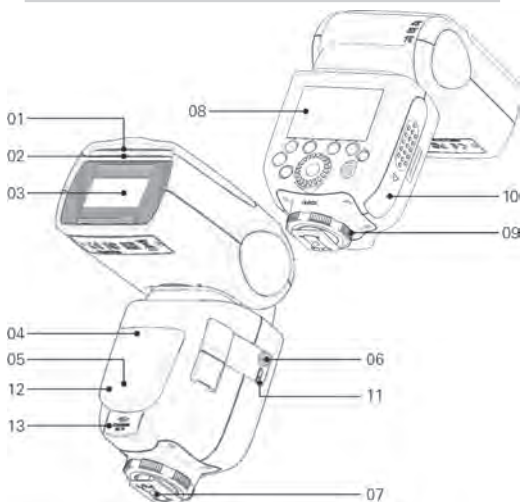

• Body

- | | |
|--------------------------|----------------------------------|
| 01. Catchlight Panel | 08. Dot-matrix LCD Panel |
| 02. Built-in Wiede Panel | 09. Lock Ring |
| 03. Flash Head | 10. Battery Compartment |
| 04. Optic Control Sensor | 11. USB Port |
| 05. Focus Assist Beam | 12. Slave Flash Ready Indicator |
| 06. Sync Cord Jack | 13. External Power Supply Socket |
| 07. Hotshoe | |

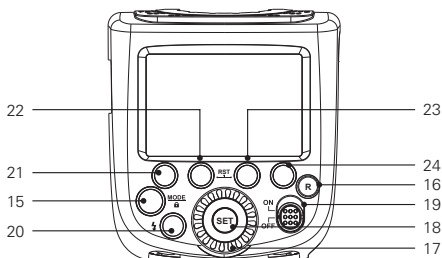

• Control Panel

- | | |
|------------------------------------------------|---------------------------------------------|
| 15. <MODE> Mode Selection Button / Lock button | 20. <⚡> Test Button / Flash Ready Indicator |
| 16. <Z> Wireless Selection Button | 21. Function Button 1 |
| 17. Select Dial | 22. Function Button 2 |
| 18. <SET> Set Button | 23. Function Button 3 |
| 19. ON/OFF Power Switch | 24. Function Button 4 |

• LCD Panel

(1) i-TTL Autoflash

Zoom: zoom display (Page 49)

A: Automatic

M: Manual (Page 40)

i-TTL: i-TTL autoflash

Focus length
(Page 49)

High-speed sync
(Page 39)

Second curtain sync
(Page 39)

Master unit flash ON

Master unit flash OFF

Flash exposure compensation
(Page 38)

Flash exposure compensation amount

F: Aperture (Page 38)

Distance indicator display

Effective flash range (Page 38)

Flash exposure sequence (Page 38)

Flash exposure bracketing

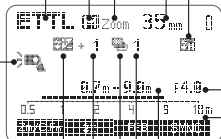

- The display will only show the settings currently applied.
- The functions displayed above functions buttons 1 to 4, such as **SYNC** and **±**, change according to settings' status.
- When a button or dial is operated, the LCD panel illuminated.

• (2) M Manual Flash

M: Manual flash

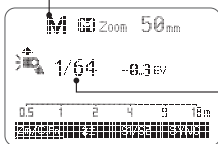

Manual flash output

• (3) Multi Flash

RPT: Stroboscopic flash

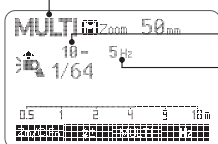

Number of flashes

Flash frequency

(4) Radio Transmission Shooting / Optic Transmission Shooting

• Master Unit

Flash mode

GR: Group flash (radio transmission)

⌘ Radio transmission wireless shooting

⚡ Optic transmission wireless shooting

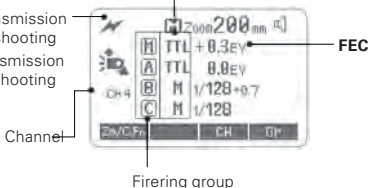

• Slave Unit

Slave icon



• What's in the Box of CUlight FR 60N?

1. Flash unit
2. Mini stand
3. Protection case
4. Instruction manual

• Separately Sold Accessories

The product can be used in combination with the following separately sold accessories:

1. CUlight 2.4 GHz Trigger Kit RT 500N & RR 500N
2. CUlight 2.4 GHz Transmitter RT 500N
3. CUlight 2.4 GHz Receiver RR 500N
4. CUlight Power Pack PP 4500
5. CUlight Power Pack Battery B 4500
6. CUlight Power Pack Cable PC 150N
7. CUlight Softbox Kit with Flashgun Holder SB 40-40 Kit
8. CUlight Softbox Kit with Flashgun Holder SB 60-60 Kit
9. CUlight Light Stand LS 2000 (200cm)
10. CUlight Light Stand LS 2500 (300cm)

Attaching to a Camera

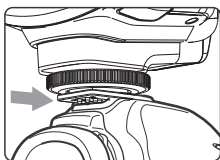

- 1 Attach the Camera Flash.
 - Slip the camera flash's mounting foot into the camera's hotshoe all the way.

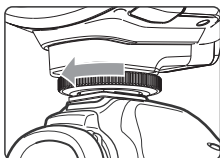

- 2 Secure the Camera Flash.
 - Rotate the lock ring on the mounting foot until it locks up.

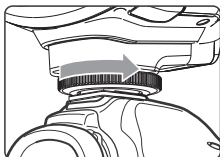

- 3 Detach the Camera Flash.
 - Rotate the lock ring on the mounting foot until it is loosened.

Power Management

Use ON/OFF Power Switch to power the flash unit on or off. Turn off if it will not be used for an extended period of time. Setting as a master flash, it will turn the power off automatically after a certain period (approx. 90 seconds) of idle use. Pressing the camera shutter halfway or pressing any flash button will wake up the flash unit. Setting as a slave flash, it will enter sleep mode after a certain period (adjustable, 60 minutes by default) of idle use. Pressing any flash button will wake it up.

b C.Fn Disabling Auto Power Off function is recommended when the flash is used off camera. (C.Fn-APO, page 50)

C.Fn Slave Auto Power Off Timer is set to 60 minutes by default. Another option "30 minutes" is available. (C.Fn- Sv APOT, page 50)

i-TTL Flash Mode

This flash has three flash modes: **i-TTL**, Manual (**M**), and **RPT** (Stroboscopic). In **i-TTL** mode, the camera and the flash will work together to calculate the correct exposure for the subject and the background. In this mode, multiple TTL functions are available: FEC, HSS, second curtain sync, modeling flash, etc.

*Press < **MODE** > Mode Selection Button and three flash modes will display on the LCD panel one by one with each pressing.

i-TTL Mode

Press < **MODE** > Mode Selection Button to enter i-TTL mode. The LCD panel will display.



- Press the camera release button halfway to focus. The aperture and effective flash range will be displayed in the viewfinder.
- When the shutter button is fully pressed, the flash will fire a pre-flash that the camera will use to calculate exposure and flash output the instant before the photo is taken.

FEC: Flash Exposure Compensation

With FEC function, this flash can adjust from -3 to +3 in 1/3rd stops. It is useful in situations where minor adjusting of the TTL system is needed based on the environment.

Setting FEC:



- 1 Press Function Button 2 <  >. The icon <  > and flash exposure compensation amount will be highlighted on the LCD panel.

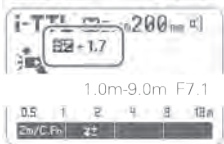

- 2 Set the flash exposure compensation amount.
 - Turn the Select Dial to set the amount.
 - "0.3" means 1/3 step, "0.7" means 2/3 step.
 - To cancel the flash exposure compensation, set the amount to "+0".





- 3 Press < **SET** > button again to confirm the settings.

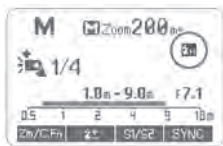

High-Speed Sync

High Speed Sync (FP flash) enables the flash to synchronize with all camera shutter speeds. This is convenient when you want to use aperture priority for fill-flash portraits.

Select the high-speed sync icon < >.





- Set the flash sync speed to 1/320s (Auto FP) or 1/250s (Auto FP) in the Nikon camera menu. Press the shutter button halfway. The icon < > displayed on the flash screen means the high speed sync function is enabled on the flash.
- Turning the camera command dial can set the shutter speed to 1/250s or faster.
- To check if the FP flash function works properly, look through the shutter speed in the viewfinder. If it shows a speed of 1/250s or faster, the FP flash function is on work.

- If you set a shutter speed as 1/320s (Auto FP) or 1/250s (Auto FP) in the Nikon camera setting, < > will be displayed in the flash screen regardless of practical shutter speed.
- With high-speed sync, the faster the shutter speed, the shorter the effective flash range.
- To return to normal flash, set the flash sync speed to other options other than Auto FP. Then the icon < > will disappear when pressing the shutter halfway.
- Multi flash mode cannot be set in high-speed sync mode.
- Over-temperature protection may be activated after 15 consecutive high-speed sync flashes.

Second-Curtain Sync

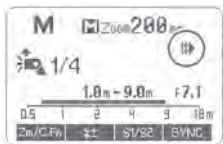
With a slow shutter speed, you can create a light train following the subject. The flash fires right before the shutter closes.



- Set the camera to Rear mode and press the shutter button halfway, then the flash display panel will show the second curtain sync icon < >.
- When the camera is not set to Rear mode, pressing the shutter button halfway will not light up the icon < > on the flash display panel.

M: Manual Flash

The flash output is adjustable from 1/1 full power to 1/128th power in 1/3rd stop increments. To obtain a correct flash exposure, use a hand-held flash meter to determine the required flash output.



1 Press **<MODE>** button so thatr **<M>** is displayed.

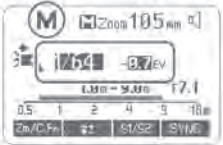

2 Turn the Select Dial to choose a desired flash output amount.

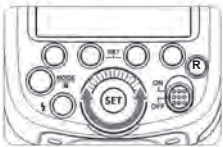

3 Press **<SET>** button again to confirm the setting.

Flash Output Range

The following table makes it easier to see how the stop changes in terms of f/stop when you increase or decrease the flash output. For example, when you decrease the flash output to 1/2, 1/2-0.3, or 1/2-0.7, and then increase the flash output to more than 1/2, 1/2+0.3, 1/2+0.7, and 1/1 will be displayed.

Figures displayed when reducing flash output level.→

1/1	1/1-0.3	1/1-0.7	1/2	1/2-0.3	1/2-0.7	1/4
	1/2+0.7	1/2+0.3		1/4+0.7	1/4+0.3	

← Figures displayed when increasing flash output level

Optic S1 Secondary Unit Setting

In M manual flash mode, press **<S1/S2>** button so that this flash can function as an optic S1 secondary flash with optic sensor. With this function, the flash will fire synchronously when the main flash fires, the same effect as that by the use of radio triggers. This helps create multiple lighting effects.

Optic S2 Secondary Unit Setting

Press **<S1/S2>** button so that this flash can also function as an optic S2 secondary flash with optic sensor in M manual flash mode. This is useful when cameras have pre-flash function. With this function, the flash will ignore a single "pre-flash" from the main flash and will only fire in response to the second, actual flash from the main unit.

Manual Off Camera High-speed Setting

In M manual flash mode, press **<SYNC>** button to select high-speed mode and **fH** is displayed.

f S1 and S2 optic triggering and off camera high-speed mode are only available in M manual flash mode.

RPT: Stroboscopic Flash

With stroboscopic flash, a rapid series of flashes is fired. It can be used to capture a multiple images of a moving subject in a single photograph.

You can set the firing frequency (number of flashes per sec. expressed as Hz), the number of flashes, and the flash output.

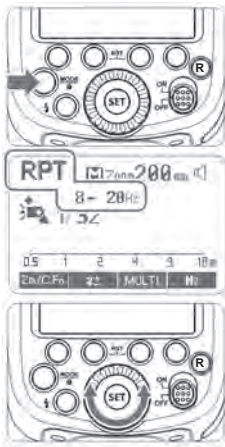

1 Press **<MODE>** button so that **<RPT>** is displayed.

2 Turn the Select Dial to choose a desired flash output.

3 Set the flash frequency and flash times.

- Press Function **Button 3** **<MULTI>** to select the item (blinks).
- Turn the Select Dial to set the number and press Function **Button 4** **<HZ>** button again to confirm. The next item to be set will blink.
- After you finish the setting, press **<SET>** button and all the settings will be displayed.

Calculating the Shutter Speed

During stroboscopic flash, the shutter remains open until the firing stops. Use the formula below to calculate the shutter speed and set it with the camera.

Number of Flashes / Flash Frequency = Shutter Speed

For example, if the number of flashes is 10 and the firing frequency is 5 Hz, the shutter speed should be at least 2 seconds.

⚠ To avoid overheating and deteriorating the flash head, do not use stroboscopic flash more than 10 times in succession. After 10 times, allow the camera flash to rest for at least 15 minutes. If you try to use the stroboscopic flash more than 10 times in succession, the firing might stop automatically to protect the flash head. If this happens, allow at least 15 minutes' rest for the camera flash.

- Stroboscopic flash is most effective with a highly reflective subject against a dark background.
- Using a tripod and a remote control is recommended.
- A flash output of 1/1 and 1/2 cannot be set for stroboscopic flash.
- Stroboscopic flash can be used with "bulb".

If the number of flashes is displayed as "--", the firing will continue until the shutter closes or the battery is exhausted. The number of flashes will be limited as shown by the following table

Maximum Stroboscopic Flashes:

Flash output \ Hz	1	2	3	4	5	6-7	8
1/4	7	6	5	4	4	3	3
1/8	14	14	12	10	8	6	5
1/16	30	30	30	20	20	20	10
1/32	60	60	60	50	50	40	30
1/64	90	90	90	80	80	70	60
1/128	90	90	90	90	90	90	80

Flash output \ Hz	10	20-50	60-199
1/4	2	2	2
1/8	4	4	4
1/16	8	8	8
1/32	20	16	12
1/64	50	30	20
1/128	70	40	40

Wireless Flash Shooting: Optic Transmission

This product is compatible with Nikon Creative Lighting System (CLS). It can function as either an optic wireless master or slave flash. As a master unit, it can control Nikon flashes e.g. SB-900 and SB-910 via wireless. As a slave unit, it can be controlled by wireless signals of Nikon flashes e.g. SB-900 and pop-up flash commanders of Nikon cameras e.g. D7100/D7000/D800.

- You can set up three slave groups for **i-TTL** autoflash shooting. With **i-TTL** autoflash, you can easily create various lighting effects.
- Any flash settings for the slave units on the master flash in **i-TTL / Manual / RPT** mode will be automatically sent to the slave units. So the only thing you need to do is to set the master unit for each slave group without any operation for the slave units at all during the shooting.
- This flash can work in **i-TTL / M / RPT / OFF** flash modes when set as a master unit.

Slave/Master Unit's Positioning and Operation Range

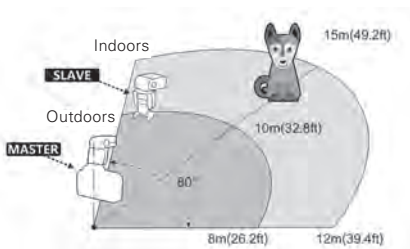

1. Wireless Settings

You can switch between normal flash and wireless flash. For normal flash shooting, be sure to set the wireless setting to OFF.

Master Unit Setting



Press **<R>** button so that **< ⚡ >** is displayed on the LCD panel. If **< ⚡ RPT >** is displayed, it means RPT mode is ON.

The backlight turns green now.

Slave Unit Setting



Press **<R>** button again so that **< ⚡ >** and **< SLAVE >** are displayed on the LCD panel.

The backlight turns orange now.

2. Setting Master Unit's Flash Mode

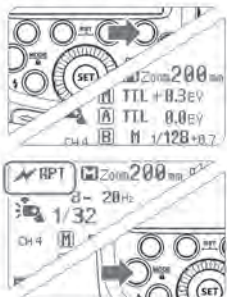

1 Press Function Button 4 **<CH>** and turn the Select Dial to choose a channel ID from 1 to 4.

2 Press the **<SET>** button to confirm.

3. Setting the Communication Channel

If there are other wireless flash systems nearby, you can change the channel IDs to prevent signal interference. The channel IDs of the master unit and the slave unit(s) must be set to the same.

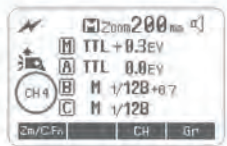

1 Press Function Button 3 **<CH>** and turn the Select Dial to choose a channel ID from 1 to 4.

2 Press the **<SET>** button to confirm.

4. i-TTL Fully Automatic Wireless Flash Shooting

Using Automatic Wireless Flash with a Single Slave Unit

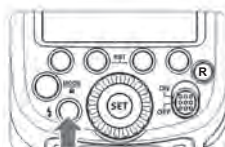
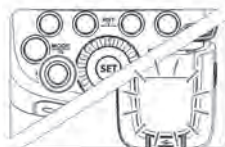
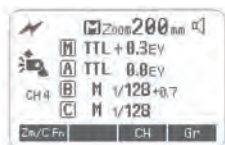

1 Master Unit Setting

- Attach a CUlight FR 60N flash unit on the camera and set it as the master flash (Page 43)
- M/A/B/C can be set as TTL mode independently.

2 Slave Unit Setting

- Set the other camera flash as the wireless slave Unit. (Page 43)
- The slave unit can be set as A/B/C.

3 Check the communication channel.

- If the master unit and slave unit(s) are set to a different channel, set them to the same channel. (Page 43)

4 Position the camera and flashes.

- Position the camera and flashes as the picture shows. (Page 42)

5 Check that the flash is ready.

- Check that the master flash ready indicator is lightened.
- When the slave flash ready indicator is ready, the AF-assist beam lighting area will blink at 1 second intervals.

6 Check the flash operation.

- Press the master unit's Test Button <⚡>.
- Then, the slave unit will fire. If not, adjust the slave unit's angle toward the master unit and distance from the master unit.

- ⚠** • The slave unit might be out of order or fire an unwanted flash due to the nearby fluorescent lamp or computer screen.

- • If the slave unit's auto power off function is workable, press the master unit's test button to power it on. Please note that test firing is unavailable during the camera's regular metering time.
- The effective time of slave auto power off is changeable. (C.Fn-Sv APOT Page 50)
 - By making some settings, the auto AF-assist transmitter will not blink after the slave unit's flash ready indicator is lightened. (C.Fn-AF Page 50)

Using Fully Automatic Wireless Flash

The FEC and other settings that set on the master unit will also be appeared on the slave unit automatically. The slave unit does not need any operation. Use the following settings to make wireless flashes according to the same methods with normal flash shooting.

- Flash Exposure Compensation ( Page 38)
- High-Speed Sync (**SYNC** Page 39)

About Master Unit

Use two or more master units. By preparing several cameras that with master units flash attached, cameras can be changed in shooting while keeping the same lighting source (slave unit).

5. M: Wireless Flash Shooting with Manual Flash

This describes wireless (multiple shooting) using manual flash. You can shoot with a different flash output setting for each slave unit (firing group). Set all parameters on the master unit.

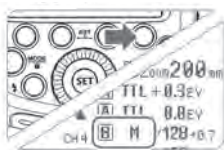

1 Setting the flash mode to <M>.

- Press Function Button 4 < **Gr** > to choose groups. Then, press Function Button 3 < **MODE** > to set the flash to M mode.

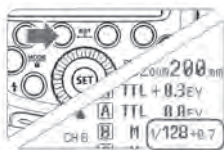

2 Setting flash output.

- Press Function Button 2 <  >. Turn the Select Dial to set the flash output of the groups. Press the < **SET** > button to confirm.

3 Taking the picture.

- Each group fires at the set flash ratio

6. RPT: Wireless Flash Shooting with Manual Flash

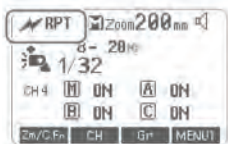

Setting < RPT > stroboscopic flash.

- Press < **MODE** > button so that <  **RPT** > is displayed.
- Setting the stroboscopic flash. (Page 41)

- The firing frequency of stroboscopic flash during the optic transmission wireless shooting can be set from 1Hz to 100Hz (settings from 250 Hz to 500 Hz are not available).

Wireless Flash Shooting: Radio (2.4G) Transmission

Using a flash (master/slave) with a radio transmission wireless shooting function make it easy to shoot with advanced wireless multiple flash lighting, in the same way as i-TTL autoflash shooting. The basic relative position and operation range are as shown in the picture. You can then perform wireless i-TTL autoflash shooting just by setting the master unit to <i>i-TTL</i>.

Positioning and Operation Range (Example of wireless flash shooting)

- Autoflash Shooting with One Slave Unit

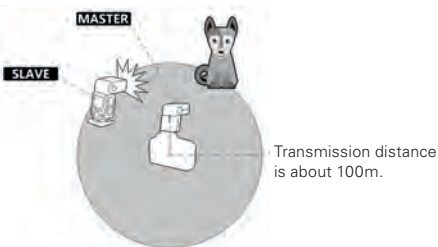

- Use the supplied mini stand to position the slave unit.
- Before shooting, perform a test flash and test shooting.
- The transmission distance might be shorter depending on the conditions such as positioning of slave units, the surrounding environment and whether conditions.

Wireless Multiple Flash Shooting

You can divide the slave units into two or three groups and perform i-TTL autoflash while changing the flash ratio (factor). In addition, you can set and shoot with a different flash mode for each firing group, for up to 5 groups.

- Auto Shooting with Two Slave Groups



- Auto Shooting with Three Slave Groups



Wireless shooting using radio transmission has advantages over wireless shooting using optic transmission, such as being less affected by obstacles, and not having to point the slave unit's wireless sensor toward the master unit. The main functional differences are as follows:

Function	Radio Transmission	Optic Transmission
Distance	100 m	15 m
Channel	1~32	1~4
To be disturbed	Hard	Easy

Other Applications

Sync Triggering

The Sync Cord Jack is a 3.5mm plug. Insert a trigger plug here and the flash will be fired synchronously with the camera shutter.

Modelling Flash

If the camera has a depth-of-field preview button, pressing it will fire the flash continuously for 1 second. This is called modeling flash.

It enables you to see the shadow effects on the subject and the lighting balance. You can fire the modeling flash during wireless or normal flash shooting.

- ⚠ • To avoid overheating and deteriorating the flash head, do not fire the modeling flash for more than 10 consecutive times. If you fire the modeling flash 10 consecutive times, allow at least 10 minutes' break for the camera flash.

Auto Focus Assist Beam

In poorly-lit or low-contrast shooting environments, the built-in auto focus assist beam will automatically light up to make it easier for autofocus. The beam will light up only when autofocus is difficult and get out as soon as the autofocus becomes correct.

If you want to turn off the auto focus assist beam, set the "AF" to "OFF" on the C.Fn settings.

- • If you find the auto focus assist beam does not light up, this is because the camera has got a correct autofocus.

Position	Effective Range
Center	0.6~10 m / 2.0~32.8 feet
Periphery	0.6~5 m / 2.0~16.4 feet

Bounce Flash

By pointing the flash head toward a wall or ceiling, the flash will bounce off the surface before illuminating the subject. This can soften shadows behind the subject for a more natural-looking shot. This is called bounce flash.

To set the bounce direction, hold the flash head and turn it to a satisfying angle.

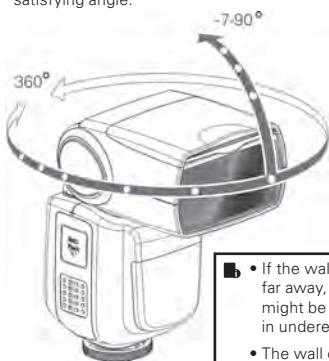

- • If the wall or ceiling is too far away, the bounced flash might be too weak and result in underexposure.
- The wall or ceiling should be a plain, white color for high reflectance. If the bounce surface is not white, a color cast may appear in the picture.

Creating a Catchlight

With the catchlight panel, you can create a catchlight in the subject's eyes to add life to the facial expression.

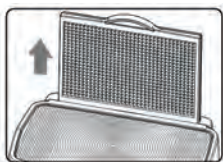

- 1 Point the flash head upward by 90°.
- 2 Pull out the wide panel. The catchlight panel will come out at the same time.
- 3 Push the wide panel back in.
 - Follow the same procedures as for bounce flash.

- Point the flash head straight ahead and then upward by 90°. The catchlight will not appear if you swing the flash head left or right.
- For best catchlight effect, stay 1.5m/4.9ft away from the subject.

ZOOM: Setting the Flash Coverage and Using the Wide Panel

The flash coverage can be set automatically or manually. It can be set to match the lens focal length from 20 mm to 200mm. Also, with the built-in wide panel, the flash coverage can be expanded for 14mm wide-angle lenses.

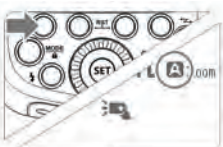

In Manual Zoom mode, press the <ZOOM/C.FN> button.

- Turn the Select Dial to change the flash coverage.
- If < A > is displayed, the flash coverage will be set automatically.

- If you set the flash coverage manually, make sure it covers the lens focal length so that the picture will not have a dark periphery.

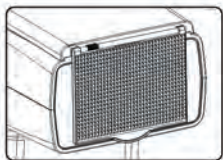

Using the Wide Panel

Pull out the wide panel and place it over the flash head as shown. The flash coverage will then be extended to 14 mm.

- The catchlight panel will come out at the same time. Push the catchlight panel back in.
- The < ZOOM/C.FN > button will not work.



Low Battery Warning

If the battery power is low,  will appear and blink on the LCD panel. Please replace the battery immediately.

Factory Settings

To restore the flash to factory settings keep pushed the function buttons 2 and 3 together for a short time.

C.Fn: Setting Custom Functions

The following table lists the available and unavailable custom functions of this flash.

C.Fn Custom Functions			
Custom Function Signs	Function	Setting No.	Setting & Description
m/ft	Distance indicator	m	m
		ft	feet
APO	Auto power off	ON	ON
		OFF	OFF
AF	AF-assist beam	ON	ON
		OFF	OFF
SvAPOT	Slave auto power off timer	60min	60min
		30min	30min
BEEP	Beeper	ON	ON
		OFF	OFF
LIGHT	Backlighting time	12sec	Off in12 sec.
		OFF	Always off
		ON	Always lighting
LCD	LCD contrast ratio	0~9	10 levels

1. Press < **Zm/C.Fn** > Backlight/Custom Setting Button for 2 seconds or longer until C.Fn menu is displayed. The "Ver x.x" in the top- right corner refers to the software version.

2. Select the Custom Function No.

Turn the Select Dial to select the Custom Function No.

3. Change the Setting.

- Press < **SET** > button and the Setting No. blinks.
- Turn the Select Dial to set the desired number. Pressing < **SET** > button will confirm the settings.

4. In the C.Fn states, long press the "Clear" button for 2 seconds until "OK" is displayed on the panel, which means the values in C.Fn can be reset.

Protection Function

1. Over-Temperature Protection

- To avoid overheating and deteriorating the flash head, do not fire more than 30 continuous flashes in fast succession at 1/1 full power. After 30 continuous flashes, allow a rest time of at least 10 minutes.
- If you fire more than 30 continuous flashes and then fire more flashes in short intervals, the inner over-temperature protection function may be activated and make the recycling time over 10 seconds. If this occurs, allow a rest time of about 10 minutes, and the flash unit will then return to normal.
- When the over-temperature protection is started,  is shown on the LCD display.

Number of flashes that will activate over-temperature protection:

Power Output Level	Number of Flashes
1/1	30
1/2 +0.7	40
1/2 +0.3	50
1/2	60
1/4(+0.3,+0.7)	100
1/8(+0.3,+0.7)	200
1/16(+0.3,+0.7)	300
1/32(+0.3,+0.7)	500
1/64(+0.3,+0.7)	1000
1/128(+0.3,+0.7)	

Number of flashes that will activate over-temperature protection in high-speed sync triggering mode

Power Output	Times
1/1	15
1/2(+0.3,+0.7)	20
1/4(+0.3,+0.7)	30
1/8(+0.3,+0.7)	
1/16(+0.3,+0.7)	40
1/32(+0.3,+0.7)	
1/64(+0.3,+0.7)	50
1/128(+0.3,+0.7)	

2. Other Protections

The system provides real-time protection to secure the device and your safety. The following lists prompts for your reference:

A failure occurs on the recycling system so that the flash cannot fire.

Please restart the flash unit. If the problem still exists, please send this product to a maintenance center.

The system gets excessive heat. Please allow a rest time of 10 minutes.

The voltage on two outlets of the flash tube is too high. Please send this product to a maintenance center.

There are some errors occurred during the upgrading process. Please using the correct firmware upgrade method.

Technical Data

Model CUlight FR 60N		
• Type		
Compatible Cameras	Nikon DSLR cameras (i-TTL autoflash)	
Guide No. (1/1 output @ 200mm)	60 (m ISO 100) 190 (feet ISO 100)	
Flash Coverage	20 to 200 mm (14mm with wide panel)	
	Auto zoom (Flash coverage set automatically) to match the lens focal length and image size)	
	Manual zoom	
	Swinging/tilting flash head (bounce flash): 0 to 360° horizontally and -7° to 90° vertically	
Flash duration	1/300 bis 1/20000 Sekunden	
• Exposure Control		
Exposure control system	i-TTL autoflash and manual flash	
Flash exposure compensation (FEC)	Manual. FEB: +3 stops in 1/3 stop increments (Manual FEC and FEB can be combined).	
Sync mode	High-speed sync (up to 1/8000 seconds), first-curtain sync, and second-curtain sync	
Multi flash	Provided (up to 100 times, 199Hz)	
• Wireless Flash		
Wireless flash function	Master, Slave, OFF	
Controllable slave groups 3	Optic: 3 (A, B and C) 2.4G: 5 (A, B, C, D and E)	
Transmission range (approx.)	Optic	Indoors: 12 to 15 m / 39.4 to 49.2 ft. Outdoors: 8 to 10 m / 26.2 to 32.8 ft. Master unit reception angle: +-40° horizontally, +130° vertically
	2.4 GHz	100m
Channels	Optic	(1, 2, 3 and 4)
	2.4 GHz	(1-32)
Slave-ready indicator	Two red indicators blink	
Modelling flash	Fired with camera's depth-of-field preview button	
• Auto Focus Assist Beam		
Effective range (approx.)	Center: 0.6-10m / 2.0-32.8 feet	
	Periphery: 0.6-5m / 2.0-16.4 feet	
• Power Supply		
AA batteries	Ni-MH batteries (recommended) or 4*LR6 alkaline batteries	
Recycling time	Approx. 0.1-2.6 seconds (enloop Ni-MH batteries of Panasonic). REd LED indicator will light up when the flash is ready.	
Full power flashes	Approx. 230 (2500mAh Ni-MH batteries)	
Power saving	Power off automatically after approx. 90 seconds of idle operation. (60 minutes if set as slave)	
• Sync Triggering Mode	Hotshoe, 3.5mm sync line, Wireless control port	
• Colour temperature	5600±200k	
• Dimensions		
W x H x D	64*76*190 mm	
Weight without battery	410g	
Weight with battery	530g	

Troubleshooting

If there is a problem, refer to this Troubleshooting Guide.

The Camera Flash cannot be charged.

- The battery is installed in the wrong direction.
→ Install the battery in the correct direction.
- The camera flash's internal battery is exhausted.
→ If < > appears and blinks on the LCD panel, replace the battery immediately.

The Camera Flash does not fire.

- The camera flash is not attached securely to the camera.
→ Attach the camera's mounting foot securely to the camera.
- The electrical contacts of the Camera Flash and camera are dirty.
→ Clean the contacts.

The power turns off by itself.

- After 90 seconds of idle operation, auto power off took effect if the flash is set as master.
→ Press the shutter button halfway or press any flash button to wake up.
- After 60 minutes (or 30 minutes) of idle operation, the flash unit will enter sleep mode if it is set as slave.
→ Press any flash button to wake up.

Auto zoom does not work.

- The camera flash is not attached securely to the camera.
→ Attach the camera flash's mounting foot to the camera.

The flash exposure is underexposed or overexposed.

- You used high-speed sync.
→ With high-speed sync, the effective flash range will be shorter. Make sure the subject is within the effective flash range displayed.
- You used Manual Flash mode.
→ Set the flash mode to i-TTL or modify the flash output.

Photos have dark corners or only parts of the target subject are illuminated.

- The focal length of lens exceeds the flash coverage.
→ Check the flash coverage you set. This flash unit has the flash coverage between 20 and 200mm, which fits medium-format cameras. Pull the wide panel out to extend the flash coverage.

Firmware Upgrade

This flash supports firmware upgrade through the USB port. Update information will be released on our official website.

- USB connection line is not included in this product. The USB port is a standard Micro USB socket. Common USB connection line is applicable.

Compatible Camera Models

This flash unit can be used on the following Nikon DSLR camera models:

Camera models ...

D800	D700	D7100	D7000	D5200	D5100	D5000
D300	D300S	D3200	D3100	D3000	D200	D70S
D810	D610	D90				

- This table only lists the tested camera models, not all Nikon DSLR series cameras. For the compatibility of other camera models, a self-test is recommended.
Rights to modify this table are retained.

Maintenance

- Shut down the device immediately should abnormal operation be detected.
- Avoid sudden impacts and the product should be dedusted regularly.
- It is normal for the flash tube to be warm when in use. Avoid continuous flashes if unnecessary.
- Maintenance of the flash must be performed by our authorized maintenance department which can provide original accessories.
- This product, except consumables e.g. flash tube, is supported with a one-year warranty.
- Unauthorized service will void the warranty.
- If the product had failures or was wetted, do not use it until it is repaired by professionals.
- Changes made to the specifications or designs may not be reflected in this manual.

Declaration of Conformity

CULLMANN GERMANY GmbH herewith declares, that this device is in compliance with the basic requirements and all other applicable regulations of the directive 1999/5/EC. You find the declaration of conformity acc. to the R&TTE directive 1999/5/EC under www.cullmann.de.



CULLMANN[®]
