

USER'S MANUAL

notebook



Notice

The company reserves the right to revise this publication or to change its contents without notice. Information contained herein is for reference only and does not constitute a commitment on the part of the manufacturer or any subsequent vendor. They assume no responsibility or liability for any errors or inaccuracies that may appear in this publication nor are they in anyway responsible for any loss or damage resulting from the use (or misuse) of this publication.

This publication and any accompanying software may not, in whole or in part, be reproduced, translated, transmitted or reduced to any machine readable form without prior consent from the vendor, manufacturer or creators of this publication, except for copies kept by the user for backup purposes.

Brand and product names mentioned in this publication may or may not be copyrights and/or registered trademarks of their respective companies. They are mentioned for identification purposes only and are not intended as an endorsement of that product or its manufacturer.

©February 2025

Trademarks

Intel, **Pentium** and **Intel Celeron** are trademarks/registered trademarks of Intel Corporation.



Preface

RE Directive

This device follows the technical standards as shown in the measurement report and was tested according to the measurement procedures in RE Directive 2014/53/EU. And our laboratories are accredited, and approved, according to ISO/IEC 17025, and this device has passed the test per this.

This device will be sold in the following EEA countries: Austria, Italy, Belgium, Liechtenstein, Denmark, Luxembourg, Finland, Netherlands, France, Norway, Germany, Portugal, Greece, Spain, Iceland, Sweden, Ireland, United Kingdom, Cyprus, Czech Republic, Estonia, Hungary, Latvia, Lithuania, Malta, Slovakia, Poland, Slovenia.

ErP Off Mode Power Consumption Statement:

The figures below note the power consumption of this computer in compliance with European Commission (EC) regulations on power consumption in off mode:

- Off Mode < 0.5W

CE Marking

This device has been tested to and conforms to the regulatory requirements of the European Union and has attained CE Marking. The CE Mark is a conformity marking consisting of the letters “CE”. The CE Mark applies to products regulated by certain European health, safety and environmental protection legislation. The CE Mark is obligatory for products it applies to: the manufacturer affixes the marking in order to be allowed to sell his product in the European market.

This product conforms to the essential requirements of the RE Directive 2014/53/EU in order to attain CE Marking. A notified body has determined that this device has properly demonstrated that the requirements of the directive have been met and has issued a favorable certificate of expert opinion. As such the device will bear the notified body number 0560 after the CE mark.

The CE Marking is not a quality mark. Foremost, it refers to the safety rather than to the quality of a product. Secondly, CE Marking is mandatory for the product it applies to, whereas most quality markings are voluntary.

FCC Statement (Federal Communications Commission)

You are cautioned that changes or modifications not expressly approved by the party responsible for compliance could void the user's authority to operate the equipment.

This equipment has been tested and found to comply with the limits for a Class B digital device, pursuant to Part 15 of the FCC Rules. These limits are designed to provide reasonable protection against harmful interference in a residential installation. This equipment generates, uses and can radiate radio frequency energy and, if not installed and used in accordance with the instructions, may cause harmful interference to radio communications. However, there is no guarantee that interference will not occur in a particular installation. If this equipment does cause harmful interference to radio or television reception, which can be determined by turning the equipment off and on, the user is encouraged to try to correct the interference by one or more of the following measures:

- Re orient or relocate the receiving antenna.
- Increase the separation between the equipment and receiver.
- Connect the equipment into an outlet on a circuit different from that to which the receiver is connected.
- Consult the service representative or an experienced radio/TV technician for help.

Operation is subject to the following two conditions:

1. This device may not cause interference.
And
2. This device must accept any interference, including interference that may cause undesired operation of the device.

FCC RF Radiation Exposure Statement:

1. This Transmitter must not be co-located or operating in conjunction with any other antenna or transmitter.
2. This equipment complies with FCC RF radiation exposure limits set forth for an uncontrolled environment. This equipment should be installed and operated with a minimum distance of 20 centimeters between the radiator and your body.



Warning

Use only shielded cables to connect I/O devices to this equipment. You are cautioned that changes or modifications not expressly approved by the manufacturer for compliance with the above standards could void your authority to operate the equipment.

IMPORTANT SAFETY INSTRUCTIONS

Follow basic safety precautions, including those listed below, to reduce the risk of fire, electric shock, and injury to persons when using any electrical equipment:

1. Do not use this product near water, for example near a bath tub, wash bowl, kitchen sink or laundry tub, in a wet basement or near a swimming pool.
2. Avoid using this equipment with a telephone line (other than a cordless type) during an electrical storm. There may be a remote risk of electrical shock from lightning.
3. Do not use the telephone to report a gas leak in the vicinity of the leak.
4. Use only the power cord and batteries indicated in this manual. Do not dispose of batteries in a fire. They may explode. Check with local codes for possible special disposal instructions.
5. This product is intended to be powered by the following AC/DC adapter, supplied with this computer model, in accordance with the model's power requirements:
 - Full Range AC/DC Adapter - AC Input 100 - 240V, 50 - 60Hz, DC Output 20V, 16.5A (**330 Watts**) minimum.

Instructions for Care and Operation

The notebook computer is quite rugged, but it can be damaged. To prevent this, follow these suggestions:

1. **Don't drop it, or expose it to shock.** If the computer falls, the case and the components could be damaged.



2. **Keep it dry, and don't overheat it.** Keep the computer and power supply away from any kind of heating element. This is an electrical appliance. If water or any other liquid gets into it, the computer could be badly damaged.

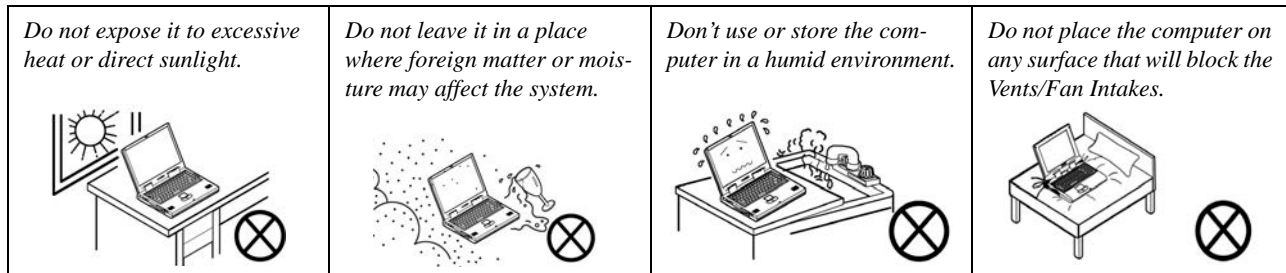

Preface

- Avoid interference.** Keep the computer away from high capacity transformers, electric motors, and other strong magnetic fields. These can hinder proper performance and damage your data.
- Follow the proper working procedures for the computer.** Shut the computer down properly and don't forget to save your work. Remember to periodically save your data as data may be lost if the battery is depleted.

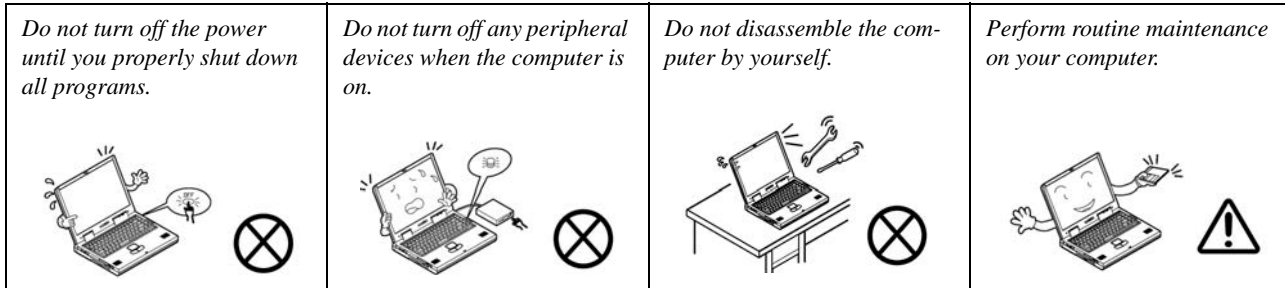

- Take care when using peripheral devices.**

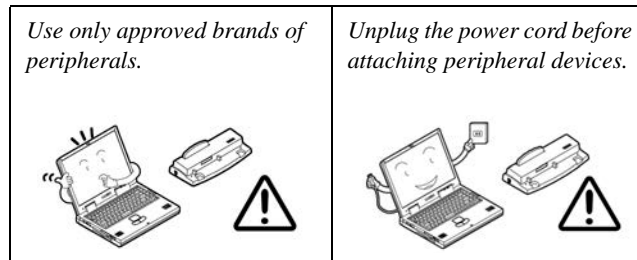

Servicing

Do not attempt to service the computer yourself. Doing so may violate your warranty and may expose you and the computer to electric shock. Refer all servicing to authorized service personnel. Unplug the computer from the power supply. Then refer servicing to qualified service personnel under any of the following conditions:

- When the power cord or AC/DC adapter is damaged or frayed.
- If the computer has been exposed to rain or other liquids.
- If the computer does not work normally when you follow the operating instructions.
- If the computer has been dropped or damaged (do not touch the poisonous liquid if the LCD panel breaks).
- If there is an unusual odor, heat or smoke coming from your computer.



Bottom Cover Removal Warning

Users should not remove any cover(s) and /or screw(s) for the purposes of device upgrade as this may violate the terms of your warranty. If you need to replace/remove the hard disk/RAM/optical device etc., for any reason, please contact your distributor/supplier for further information.

Removal Warning

When removing any cover(s) and screw(s) for the purposes of device upgrade, remember to replace the cover(s) and screw(s) before restoring power to the system.

Also note the following when the cover is removed:

- Hazardous moving parts.
- Keep away from moving fan blades.

Power Safety

The computer has specific power requirements:

- Only use a power adapter approved for this computer. Using the wrong adapter can damage the computer and/or adapter.
- It's essential to fully plug an AC/DC adapter into the jack on the computer to ensure a secure connection and prevent issues like poor charging or an electrical short circuit.
- Don't put the adapter on the ground while it's in use, as it could be damaged by office chair wheels.
- Do not let the AC/DC adapter hang down from the computer as the weight of the box could damage the DC Jack.
- Before using the adapter, ensure the connectors on the adapter and device are free of dust or other debris.
- When you're not using the computer or when it's fully charged, unplug the adapter from both the power outlet and the device. This reduces the risk of electrical hazards and energy consumption.
- Remove the adapter before moving the computer (if you want to keep the computer powered by the AC/DC adapter then hold the power brick so that there is no tension on the DC-In Jack).
- If you need to look under the computer, lift it up carefully; do not tilt it so that pressure is applied to the area around the DC-In jack.
- Never expose the adapter's prongs or cables to metallic objects or conductive materials. A short circuit can cause electrical shock, fires, or damage the equipment.
- Plugging the adapter into a surge protector can help prevent damage from electrical surges, such as those caused by lightning or power grid fluctuations.
- Your AC/DC adapter may be designed for international travel but it still requires a steady, uninterrupted power supply. If you are unsure of your local power specifications, consult your service representative or local power company.
- The power adapter may have either a 2-prong or a 3-prong grounded plug. The third prong is an important safety feature; do not defeat its purpose. If you do not have access to a compatible outlet, have a qualified electrician install one.

- When you want to unplug the power cord, be sure to disconnect it by the plug head, not by its wire.



Power Safety Warning

Before you undertake any upgrade procedures, make sure that you have turned off the power, and disconnected all peripherals and cables (including telephone lines and power cord).

You must also remove your battery in order to prevent accidentally turning the machine on. **Before removing the battery disconnect the AC/DC adapter from the computer.**

- Make sure the socket and any extension cord(s) you use can support the total current load of all the connected devices.
- Before cleaning the computer, make sure it is disconnected from any external power supplies (i.e. AC/DC adapter or car adapter).
- Avoid using the adapter in excessively hot, cold, or humid environments. Store and use the adapter at room temperature for optimal performance.

Do not plug in the power cord if you are wet.



Do not use the power cord if it is broken.

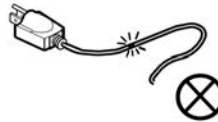

Do not place heavy objects on the power cord.

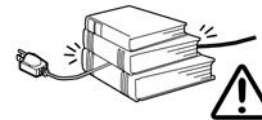

Polymer/Lithium-Ion Battery Precautions

Note the following information which is specific to Polymer/Lithium-Ion batteries only, and where applicable, this overrides the general battery precaution information overleaf.

- Polymer/Lithium-Ion batteries may experience a slight expansion or swelling, however this is part of the battery's safety mechanism and is not a cause for concern.
- Use proper handling procedures when using Polymer/Lithium-Ion batteries. Do not use Polymer/Lithium-Ion batteries in high ambient temperature environments, and do not store unused batteries for extended periods.
- If you are working in areas of low temperature use the AC/DC adapter to power the computer.

See also the general battery precautionary information overleaf for further information.

General Battery Precautions

- Only use batteries designed for this computer. The wrong battery type may explode, leak or damage the computer.
- Do not remove any batteries from the computer while it is powered on.
- Do not continue to use a battery that has been dropped, or that appears damaged (e.g. bent or twisted) in any way. Even if the computer continues to work with a damaged battery in place, it may cause circuit damage, which may possibly result in fire.
- If you do not use the battery for an extended period, then remove the battery from the computer for storage.
- Recharge the batteries using the notebook's system. Incorrect recharging may make the battery explode.
- Do not try to repair a battery pack. Refer any battery pack repair or replacement to your service representative or qualified service personnel.
- Keep children away from, and promptly dispose of a damaged battery. Always dispose of batteries carefully. Batteries may explode or leak if exposed to fire, or improperly handled or discarded.
- Keep the battery away from metal appliances.
- Affix tape to the battery contacts before disposing of the battery.
- Do not touch the battery contacts with your hands or metal objects.



Battery Disposal & Caution

The product that you have purchased contains a rechargeable battery. The battery is recyclable. At the end of its useful life, under various state and local laws, it may be illegal to dispose of this battery into the municipal waste stream. Check with your local solid waste officials for details in your area for recycling options or proper disposal.

Danger of explosion if battery is incorrectly replaced. Replace only with the same or equivalent type recommended by the manufacturer. Discard used battery according to the manufacturer's instructions.

Cleaning

Do not apply cleaner directly to the computer; use a soft clean cloth.

Do not use volatile (petroleum distillates) or abrasive cleaners on any part of the computer.

Cleaning Instructions

(For Computer Models Supplied with Light Blue Cleaning Cloth)

Some computer models in this series come supplied with a light blue cleaning cloth. To clean the computer case with this cloth follow the instructions below:

1. Power off the computer and peripherals.
2. Disconnect the AC/DC adapter from the computer.
3. Use a little water to dampen the cloth slightly.
4. Clean the computer case with the cloth.
5. Dry the computer with a dry cloth, or allow it time to dry before turning on.
6. Reconnect the AC/DC adapter and turn the computer on.

Travel Considerations

As you get ready for your trip, run through this list to make sure the system is ready to go:

1. Check that the battery pack and any spares are fully charged.
2. Power off the computer and peripherals.
3. Close the display panel and make sure it's latched.
4. Disconnect the AC/DC adapter and cables. Stow them in the carrying bag.
5. The AC/DC adapter uses voltages from 100 to 240 volts so you won't need a second voltage adapter. However, check with your travel agent to see if you need any socket adapters.
6. Put the notebook in its carrying bag and secure it with the bag's straps.
7. If you're taking any peripherals (e.g. a printer, mouse or digital camera), pack them and those devices' adapters and/or cables.
8. Anticipate customs - Some jurisdictions may have import restrictions or require proof of ownership for both hardware and software. Make sure your "papers" are handy.



Power Off Before Traveling

Make sure that your notebook is completely powered off before putting it into a travel bag (or any such container). Putting a notebook which is powered on in a travel bag may cause the Vents/Fan Intakes to be blocked. To prevent your computer from overheating make sure nothing blocks the Vent/Fan Intakes while the computer is in use.

On the Road

In addition to the general safety and maintenance suggestions in this preface, and Chapter 8: Troubleshooting, keep these points in mind:

Hand-carry the notebook - For security, don't let it out of your sight. In some areas, computer theft is very common. Don't check it with "normal" luggage. Baggage handlers may not be sufficiently careful. Avoid knocking the computer against hard objects.

Beware of Electromagnetic fields - Devices such as metal detectors & X-ray machines can damage the computer, hard disk, floppy disks, and other media. They may also destroy any stored data - Pass your computer and disks around the devices. Ask security officials to hand-inspect them (you may be asked to turn it on). **Note:** Some airports also scan luggage with these devices.

Fly safely - Most airlines have regulations about the use of computers and other electronic devices in flight. These restrictions are for your safety, follow them. If you stow the notebook in an overhead compartment, make sure it's secure. Contents may shift and/or fall out when the compartment is opened.

Get power where you can - If an electrical outlet is available, use the AC/DC adapter and keep your battery(ies) charged.

Keep it dry - If you move quickly from a cold to a warm location, water vapor can condense inside the computer. Wait a few minutes before turning it on so that any moisture can evaporate.

Developing Good Work Habits

Developing good work habits is important if you need to work in front of the computer for long periods of time. Improper work habits can result in discomfort or serious injury from repetitive strain to your hands, wrists or other joints. The following are some tips to reduce the strain:

- Adjust the height of the chair and/or desk so that the keyboard is at or slightly below the level of your elbow. Keep your forearms, wrists, and hands in a relaxed position.
- Your knees should be slightly higher than your hips. Place your feet flat on the floor or on a footrest if necessary.
- Use a chair with a back and adjust it to support your lower back comfortably.
- Sit straight so that your knees, hips and elbows form approximately 90-degree angles when you are working.
- Take periodic breaks if you are using the computer for long periods of time.



Remember to:

- Alter your posture frequently.
- Stretch and exercise your body several times a day.
- Take periodic breaks when you work at the computer for long periods of time. Frequent and short breaks are better than fewer and longer breaks.



Lighting

Proper lighting and a comfortable viewing angle can reduce eye strain and shoulder and neck muscle fatigue.

- Position the display to avoid glare or reflections from overhead lighting or outside sources of light.
- Keep the display screen clean and set the brightness and contrast to levels that allow you to see the screen clearly.
- Position the display directly in front of you at a comfortable viewing distance.
- Adjust the display-viewing angle to find the best position.

LCD Screen Care

To prevent **image persistence** on LCD monitors (caused by the continuous display of graphics on the screen for an extended period of time) take the following precautions:

- Set the *Windows* **Power Plans** to turn the screen off after a few minutes of screen idle time.
- Use a rotating, moving or blank screen saver (this prevents an image from being displayed too long).
- Rotate desktop background images every few days.
- Turn the monitor off when the system is not in use.

LCD Electro-Plated Logos

Note that in computers featuring a raised LCD electro-plated logo, the logo is covered by a protective adhesive. Due to general wear and tear, this adhesive may deteriorate over time and the exposed logo may develop sharp edges. Be careful when handling the computer in this case, and avoid touching the raised LCD electro-plated logo. Avoid placing any other items in the carrying bag which may rub against the top of the computer during transport. If any such wear and tear develops contact your distributor/supplier.

⚠ WARNING

- **INGESTION HAZARD:** This product contains a button cell or coin battery.
- **DEATH** or serious injury can occur if ingested.
- A swallowed button cell or coin battery can cause **Internal Chemical Burns** in as little as **2 hours**.
- **KEEP** new and used batteries **OUT OF REACH** of **CHILDREN**.
- **Seek immediate medical attention** if a battery is suspected to be swallowed or inserted inside any part of the body.



- The product contains non-replaceable batteries (Nominal voltage: 3Vdc / Battery Type: CR2032).
- Remove and immediately recycle or dispose of used batteries, batteries from equipment not used for an extended period of time according to local regulations and keep away from children. Do NOT dispose of batteries in household trash or incinerate.
- Even used batteries may cause severe injury or death.
- Call a local poison control center for treatment information.
- Non-rechargeable batteries are not to be recharged.
- Do not force discharge, recharge, disassemble, heat above (manufacturer's specified temperature rating) or incinerate. Doing so may result in injury due to venting, leakage or explosion resulting in chemical burns.

Contents

Notice	I
ErP Off Mode Power Consumption Statement:	II
FCC Statement	IV
(Federal Communications Commission)	IV
FCC RF Radiation Exposure Statement:	V
Instructions for Care and Operation	VII
Servicing	IX
Power Safety	X
Polymer/Lithium-Ion Battery Precautions	XII
General Battery Precautions	XIII
Cleaning	XIV
Cleaning Instructions	XIV
Travel Considerations	XV

Quick Start Guide

Overview	1-1
Advanced Users	1-2
Beginners and Non-Advanced Users	1-2
Warning Boxes	1-2
Not Included	1-3
System Startup	1-4
System Software	1-6

Preface

Model Differences	1-7
Manual Graphics	1-7
LCD Panel Open	1-8
LED Indicators	1-9
Illuminated Colored LED Keyboard	1-10
Keyboard Backlight LED Device	1-11
Keyboard Shortcuts	1-12
Function/Hot Key Indicators	1-13
Control Center	1-14
Front/Left Views - Model A	1-15
Front/Left Views - Model B	1-17
Rear View - Model A	1-19
Rear View - Model B	1-20
Right View - Model A	1-21
Right View - Model B	1-23
Bottom View	1-25
Windows 11 Start Menu	1-26
Right-Clicking the Windows Logo In Start Menu	1-27
Windows 11 Control Panel	1-29
Windows 11 Settings	1-30
Windows 11 Taskbar	1-31
Windows 11 Action Center	1-32

Video Features1-33
 NVIDIA Advanced Optimus Capable Technology1-34
 NVIDIA Advanced Optimus1-34
 Power Options1-40

Features & Components

Overview2-1
 Solid State Drive2-2
 MicroSD Push-Push Card Reader2-3
 Clickpad and Buttons/Mouse2-4
 Touchpad Sensitivity2-4
 Mouse Properties Control Panel2-5
 Mouse & Touchpad Devices2-7
 Realtek Audio Console2-14
 Realtek Audio Console - Main2-15
 Realtek Audio Console - Speakers2-16
 Realtek Audio Console - Microphone2-17
 Realtek Audio Console - Device Advanced Settings2-18

Power Management

Overview3-1
 The Power Sources3-2
 AC/DC Adapter3-2

Preface

Battery	3-3
Turning On the Computer	3-4
Shutting the Computer Down	3-5
Settings Menu Power Controls	3-6
Power Plans	3-11
Power-Saving States	3-13
Sleep	3-13
Hibernate	3-14
Shut down	3-14
Configuring the Power Buttons	3-15
Resuming Operation	3-17
Battery Information	3-19
Battery Power	3-19
Conserving Battery Power	3-21
Battery Life	3-22
New Battery	3-22
Recharging the Battery with the AC/DC Adapter	3-23
Proper handling of the Battery Pack	3-23
Battery FAQ	3-24

Drivers & Utilities

What to Install	4-1
Module Driver Installation	4-1

Driver Installation	4-2
Updating/Reinstalling Individual Drivers	4-5
User Account Control	4-6
Windows Security Message	4-6
New Hardware Found	4-6
Driver Installation Procedure	4-7
Chipset	4-7
Serial IO	4-7
VGA Driver	4-7
NVIDIA Video (VGA)	4-8
NVIDIA App	4-8
Control Center	4-8
LAN	4-8
CardReader	4-9
Intel® HID Filter Driver	4-9
MEI Driver	4-9
Intel® Dynamic Tuning Technology Driver	4-9
Creative Sound Blaster Studio Pro 2 Audio	4-10
Audio	4-10
Creative Sound Blaster Studio Pro 2 Audio App	4-11
Optional Drivers	4-12

BIOS Utilities

Overview	5-1
The Insyde BIOS Utility	5-2
Updating the BIOS / CPU	5-3
UEFI Boot	5-4
Insyde BIOS Start Screen	5-5
Insyde BIOS Start Screen Options:	5-6
Boot Manager	5-7
Boot From File / File Explorer	5-8
Administer Secure Boot	5-9
Setup Utility - Main Menu	5-11
Setup Utility - Advanced Menu	5-13
Setup Utility - Security Menu	5-20
Setup Utility - Boot Menu	5-23
Setup Utility - Exit Menu	5-25

Modules & Options

Overview	6-1
RAID Mode Setup	6-2
RAID Setup	6-4
Deleting a RAID	6-10
Wireless LAN Module	6-11
Intel® WLAN Driver Installation	6-12

Killer WLAN Combo Driver Installation	6-13
WLAN Configuration in Windows	6-14
Killer Intelligence Center	6-17
Dashboard	6-18
Prioritization Engine	6-19
Bluetooth Module	6-20
Intel & Killer Bluetooth Combo Driver Installation	6-21
Bluetooth Configuration in Windows	6-22
To Make Your Computer Discoverable to Bluetooth Devices	6-25
Intel® Speed Shift Technology Driver	6-26
Speed Shift Technology Driver Installation	6-26
X-Rite Color Assistant	6-27
X-Rite Color Assistant Installation	6-27
Intel® GNA Driver	6-32
Intel GNA Driver Installation	6-32
Intel® Neural Processing Unit Driver	6-33
Intel NPU Driver Installation	6-33
Intel® Platform Monitoring Technology Driver	6-34
Intel PMT Driver Installation	6-34
Webcam Module	6-35
Webcam Driver Installation	6-35
Camera App	6-36

Preface

Taking Pictures/Capturing Video	6-40
IR (Hello) Camera	6-42
Webcam Driver Installation	6-42
Hello Camera Module Configuration	6-43
Intel® Rapid Storage Technology	6-45
IRST Driver Installation	6-45
Intel® Optane™ Memory & Storage Management	6-46
Intel® Optane™ Memory & Storage Management for RAID Systems	6-47
Creative Sound Blaster Studio Pro 2 Audio	6-51
Creative Sound Blaster Studio Pro 2 Installation	6-51
Creative Sound Blaster Studio Pro 2 Audio App	6-52
Creative Application	6-53
Device	6-54
Sound Mode	6-55
Acoustic Engine	6-56
Equalizer	6-57
SuperWide	6-58
SoundFit	6-59
SmartComms Kit	6-60
Crystal Voice	6-61
Scout Mode	6-62
Mixer	6-63

Playback6-64

Recording6-65

Trusted Platform Module6-67

Enabling & Activating TPM6-68

TPM Management in Windows6-69

TPM Actions6-71

Troubleshooting

Overview7-1

Basic Hints and Tips7-2

Backup and General Maintenance7-3

Viruses7-4

Upgrading and Adding New Hardware/Software7-5

Problems and Possible Solutions7-7

Interface (Ports & Jacks)

Notebook Ports & JacksA-2

Video Driver Controls

OverviewB-1

NVIDIA Advanced Optimus Capable TechnologyB-2

NVIDIA Advanced OptimusB-3

Display Mode - BIOSB-4

Video Driver InstallationB-6

Preface

VGA Driver	B-6
NVIDIA Video (VGA)	B-7
NVIDIA App	B-7
NVIDIA App	B-8
Configure Other Displays Using Project	B-9
Configuring an External Display In Windows	B-10
HDMI Audio Configuration	B-11
Wireless Display Configuration	B-13
Intel® Graphics Command Center	B-15
Display Devices & Options	B-27
Attaching Other Displays	B-28
NVIDIA Control Panel	B-31
Adjust Image Settings with Preview	B-33
Manage 3D Settings	B-34
Configure Surround, PhysX®	B-37
Change Resolution	B-41
HDCP Status	B-42
Set Digital Audio	B-43
Adjust Video Settings	B-44
Manage Display Mode	B-45
Advanced Optimus Modes	B-47
G-SYNC	B-49

Display Devices - NVIDIA CP B-50
 Configuring an External Display (NVIDIA) B-52

Specifications

Display C-2
 Memory C-2
 Storage C-2
 Audio C-2
 Pointing Device & Keyboard C-2
 Interface C-2
 Card Reader C-3
 Slot C-3
 Communication C-3
 Power Management C-3
 Power & Battery C-3
 Security C-3
 Features (For Some Model Designs) C-3
 Operating System C-4
 Indicators C-4
 BIOS C-4
 Environmental Spec C-4
 Dimensions & Weight C-4

Chapter 1: Quick Start Guide

Overview

This Quick Start Guide is a brief introduction to the basic features of your computer, to navigating around the computer and to getting your system started. The remainder of the manual covers the following:

- **Chapter 2** A guide to using some of the main features of the computer e.g. the **storage devices, TouchPad & Mouse & Audio**.
- **Chapter 3** The computer's **power** saving options.
- **Chapter 4** The installation of the **drivers** and utilities essential to the operation or improvement of some of the computer's subsystems.
- **Chapter 5** An outline of the computer's built-in software or **BIOS** (Basic Input Output System).
- **Chapter 6** A quick guide to the computer's **PC Camera, Wireless LAN, Combo Bluetooth & WLAN** and **Intel** modules (some of which may be **optional** depending on your purchase configuration).
- **Chapter 7** A **troubleshooting** guide.
- **Appendix A** Definitions of the **interface, ports/jacks** which allow your computer to communicate with external devices.
- **Appendix B** Information on the **Video driver controls**.
- **Appendix C** The computer's **specification**.

Advanced Users

If you are an advanced user you may skip over most of this Quick Start Guide. However you may find it useful to refer to *“What to Install” on page 4 - 1* and *“BIOS Utilities” on page 5 - 1* in the remainder of the User’s Manual. You may also find the notes marked with a  of interest to you.

Beginners and Non-Advanced Users



Notes

Check the light colored boxes with the mark above to find detailed information about the computer’s features.

If you are new to computers (or do not have an advanced knowledge of them) then the information contained in the Quick Start Guide should be enough to get you up and running. Eventually you should try to look through all the documentation (more detailed descriptions of the functions, setup and system controls are covered in the remainder of the User’s Manual), but do not worry if you do not understand everything the first time. Keep this manual nearby and refer to it to learn as you go. You may find it useful to refer to the notes marked with a  as indicated in the margin. For a more detailed description of any of the interface ports and jacks see *“Interface (Ports & Jacks)” on page A - 1*.

Warning Boxes

No matter what your level please pay careful attention to the warning and safety information indicated by the  symbol. Also please note the safety and handling instructions as indicated in the *Preface*.

Not Included

Operating Systems (e.g. *Windows*) and applications (e.g. word processing, spreadsheet and database programs) have their own manuals, so please consult the appropriate manuals.



Drivers

If you are installing new system software, or are re-configuring your computer for a different system, you will need to install the drivers listed in ***“Drivers & Utilities” on page 4 - 1***. Drivers are programs which act as an interface between the computer and a hardware component e.g. a wireless network module. It is very important that you install the drivers in the order listed. You will be unable to use most advanced controls until the necessary drivers and utilities are properly installed. If your system hasn't been properly configured (your service representative may have already done that for you); refer to ***Chapter 4*** for installation instructions.

Ports and Jacks

See ***“Interface (Ports & Jacks)” on page A - 1*** for a description of the interface (ports & jacks) which allow your computer to communicate with external devices, connect to the internet etc.

System Startup

1. Remove all packing materials, and place the computer on a stable surface.
2. Securely attach any peripherals you want to use with the notebook (e.g. keyboard and mouse) to their ports.
3. **When first setting up the computer use the following procedure** (as to safeguard the computer during shipping, the battery will be locked to not power the system until first connected to the AC/DC adapter and initially set up as below):
 - Fully insert the AC/DC adapter cord into the DC-In jack at the rear of the computer, then plug the AC power cord into an outlet, and connect the AC power cord to the AC/DC adapter and the battery will now be unlocked.

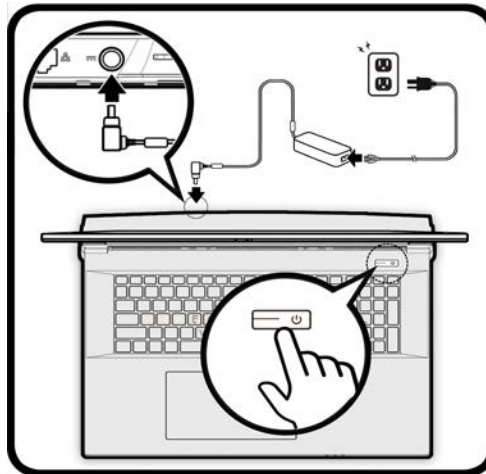

Figure 1 - 1 - Computer with AC/DC Adapter Plugged-In

4. Keep the AC/DC adapter connected to the computer to fully charge the battery to 100% capacity (the battery LED indicator will turn green)
5. Use one hand to raise the lid/LCD to a comfortable viewing angle (**do not exceed 130 degrees**); use the other hand to support the base of the computer (**Note: Never** lift the computer by the lid/LCD).
6. Press the power button on the computer to turn it on.

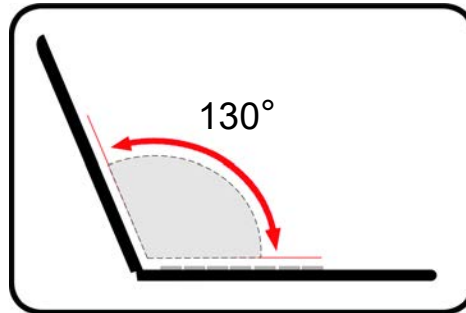

Figure 1 - 2 - Opening the Lid/LCD

System Software

Your computer may already come with system software pre-installed. Where this is not the case, or where you are re-configuring your computer for a different system, you will find the **Windows 11 (64-bit)** operating system is supported.



Windows OS

Note that the information included on the following pages is for **Windows 11 only**.

In order to run **Windows 11 (64-bit)** your computer requires a minimum **8GB** of system memory (RAM).

Shutdown

Note that you should always shut your computer down by choosing the **Shut Down** command in **Windows**. This will help prevent hard disk or system problems.

Model Differences

This notebook series includes **different models and designs** based on specification, and these may also vary slightly in appearance. Note that though your computer may look slightly different from that pictured throughout this manual, all ports, jacks (other than those indicated in the specification) and general functions are the same for all the design styles (see [Appendix C](#) for further details).

Manual Graphics

Note that the pictures, illustrations and screenshots throughout this manual are correct at time of going to press. However, these are subject to change and revision, therefore your computer's actual screens may appear slightly different from those pictured.

Figure 1 - 3
LCD Panel Open

1. Built-in Dual Webcam (*with camera shutter)
2. Webcam LED
3. Built-In Array Microphone
4. LCD
5. Power Button
6. Keyboard
7. Clickpad & Buttons



Note that the Touchpad/Clickpad and Buttons have a valid operational area indicated within the dotted lines above.

The terms Clickpad and Touchpad are interchangeable throughout this manual

LCD Panel Open

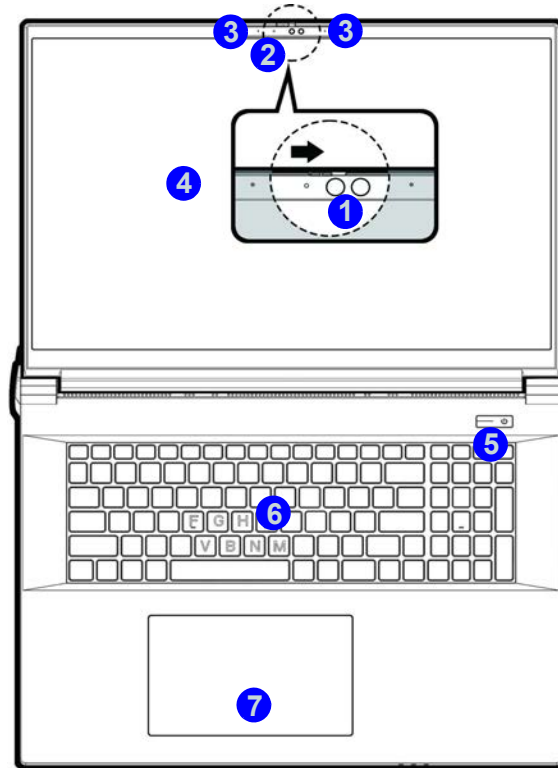

Wireless Device Operation Aboard Aircraft

The use of any portable electronic transmission devices aboard aircraft is usually prohibited. Make sure the **WLAN and Bluetooth module(s)** are **OFF** if you are using the computer aboard aircraft by putting the system in to **Airplane Mode** (see [Table 1 - 4, on page 1 - 13](#)).

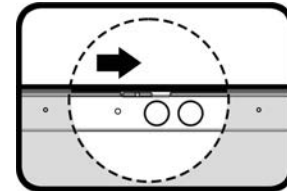

*Slide the webcam shutter to the right to ensure privacy when the camera is not in use (when the shutter is closed a red dot will be visible in the camera lens).

LED Indicators

The LED indicators on the computer display helpful information about the power status of the computer.





Icon	Color	Description
		
	Orange	DC Power is Plugged In (Computer is Off)
	Blinking Orange	The AC/DC Adapter is Plugged In and the Powered USB Port is On
	Green	The Computer is On
	Blinking Green	The Computer is in Sleep Mode
	Orange	The Battery is Charging
	Green	The Battery is Fully Charged
	Blinking Orange	The Battery Has Reached Critically Low Power Status
	Green	Storage Device Activity

Table 1 - 1 - LED Indicators



Other Keyboards

If your keyboard is damaged or you just want to make a change, you can use any standard USB keyboard. The system will detect and enable it automatically. However special functions/hot-keys unique to the system's regular keyboard may not work.

ScrLk

Hold down the **Fn Key** and **ScrLk** to enable scroll lock, and check the LED indicator for status.

Microsoft Copilot

Microsoft Copilot is an AI-powered tool that aims to aid user efficiency by supporting Microsoft 365, offering suggestions, and automating tasks.

Illuminated Colored LED Keyboard

The **illuminated colored “Per Key” LED keyboard** has an embedded numerical keypad for easy numeric data input, and features function keys to allow you to change operational features instantly. See [Table 1 - 4, on page 1 - 13](#) for full function key combination details.





Figure 1 - 4 - Illuminated Colored LED Keyboard



Special Characters

Some software applications allow the number-keys to be used with **Alt** to produce special characters. These special characters can only be produced by using the numeric keypad. Regular number keys (in the upper row of the keyboard) will not work. Make sure that **NumLk** is on.

Keyboard Backlight LED Device

Press **Fn** plus the  **2** key to toggle the keyboard LED on/off. The keyboard LED may be configured using the **Fn + key combination** outlined in the table below. In addition press **Fn** plus the  **1** key to launch the keyboard backlight application to configure the settings.





Main Keyboard Colored LED Function key Combinations		
Fn + 	1 Launch the Keyboard Backlight Application	
Fn + 	2 Toggle the Keyboard Backlight LED On/Off	
Fn + 	3 Keyboard Backlight LED Low	
Fn + 	4 Keyboard Backlight LED High	

Table 1 - 2 - Main Keyboard LEDs (for Illuminated Colored Keyboards Only)



Menu/Application Keyboard Shortcut

When the Desktop app is running you can use the Menu/Application key  on the keyboard to display the context menu as per a mouse right-click.

Keyboard Shortcuts

The following Windows Logo Key (Winkey) keyboard shortcuts are useful for navigation/operation in *Windows*.

Windows Logo  Key +	Description
Tap Winkey	Toggle the Start menu
A	Open the Action Center
B	Select the Taskbar Notification Area
D	Toggle the Desktop
E	Launch File Explorer (Quick Access tab)
+ Number (1, 2, etc)	Launch an application from the taskbar (numbered from left to right)

Table 1 - 3 - Keyboard Shortcuts

Function/Hot Key Indicators

Keys	Function	Keys	Function
Fn + Play/Pause	Play/Pause (in Audio/Video Programs)	Fn + F12	Sleep Toggle
Fn + F1	Touchpad Toggle	Fn + Num Lk	Number Lock Toggle
Fn + F2	Turn Display Backlight Off (Press a key to or use touchpad to turn on)	Fn + Scr Lk	Scroll Lock Toggle
Fn + F3	Mute Toggle	Caps Lock	Caps Lock Toggle
Fn + F5/F6	Volume Decrease/Increase	Fn + Esc	Control Center Toggle
Fn + F7	Change Display Configuration	Fn + Backspace	Flexikey® Enable/Disable
Fn + F8/F9	Display Brightness Decrease/Increase	Fn + 1	*Fan Control Toggle Automatic / Maximum
Fn + F10	Webcam Power Toggle	*Note: It is recommended that you use Maximum fan speed when playing games.	
Fn + F11	Airplane Mode Toggle	Fn + 3	Power Modes Toggle
Fn + 4	Microphone Toggle	Fn + Power Button	Toggle power to Powered USB Port

Table 1 - 4 - Function & Hot Key Indicators

Control Center

Run the **Control Center (fn hotkeys and OSD)** from the **Windows Start** menu or use the **Fn + Esc** key combination, or double-click the icon in the notification area of the taskbar. The **Control Center** provides quick access to **Power Modes**, **Fan** settings, **Preferences** and **LED Keyboard** (if your purchase configuration includes an LED Keyboard) configuration. There is a Help menu available with the Control Center.

Note that the **LED Light Bar** module is configurable from the Control Center.

Front/Left Views - Model A

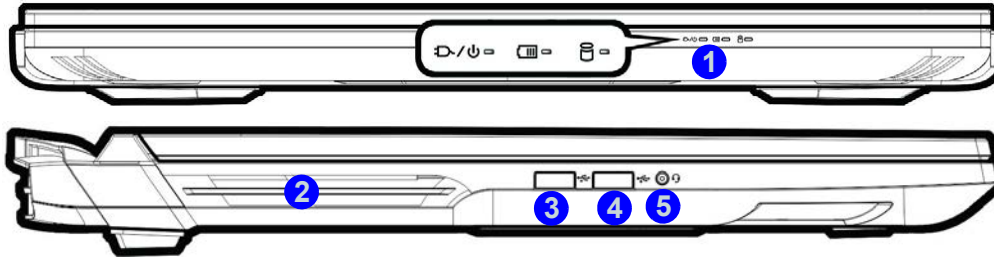

Figure 1 - 5
Front & Left Views

1. LED Indicators
2. Vent/Fan Intake/Outlet
3. USB 3.2 Gen 2 Port (Type A)
4. AC/DC Powered USB 3.2 Gen 2 Port (Type A) (see over)
5. 2-In-1 Audio Jack (Headphone/Microphone)



2-In-1 Audio Jack

Note that 2-In-1 combination audio jacks can support headphones, microphones, or headsets (i.e. a combination microphone/headphone).

1. When a device is plugged in to the combination audio jack a dialog (“Which device did you plug in?”) box will pop-up



2. Make sure you select the correct device from the drop-down menu corresponding to the device plugged-in (e.g. **choose “Headset” if you have plugged-in a headset** and do not choose headphone in this case), and then click **OK** to save the setting.



Overheating

To prevent your computer from overheating make sure nothing blocks the Vent/Fan Intake while the computer is in use.



USB & Thunderbolt™ Ports

This computer model features two USB 3.2 Gen 2 Type A ports (including 1 AC/DC Powered USB Port), one Thunderbolt™ 5 port and one Thunderbolt™ 5 port with Power Delivery DC-In.

Note: The maximum amount of current supplied by the USB ports is 900 mA for USB 3.2. The maximum amount of current supplied by the Thunderbolt port is 5V/3A in AC mode or 5V/1.5A in DC mode.

Powered USB Port

Note that the powered USB 3.2 Gen 2 port (Type A) is not operational under DOS and does not support wake on USB. The **powered USB 3.2** (4 in *Figure 1 - 5 on page 1 - 15*) port can supply power (**for charging devices only, not for operating devices**) when the system is off but still powered by the AC/DC adapter plugged into a working outlet, or powered by the battery with a capacity level above 20% (this may not work with certain devices). Toggle power to this port by using **Fn + power button**.

Front/Left Views - Model B

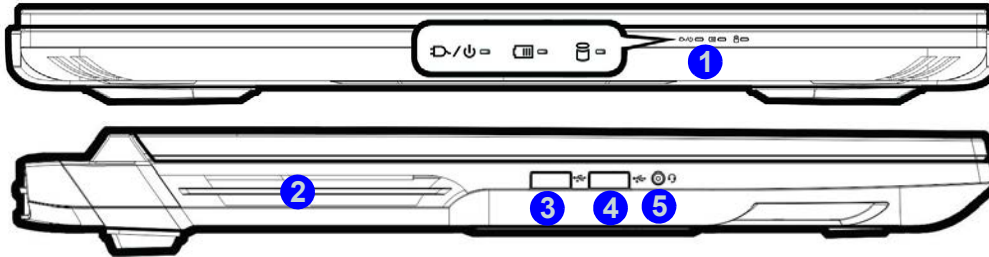

Figure 1 - 6
Front & Left Views

1. LED Indicators
2. Vent/Fan Intake/Outlet
3. USB 3.2 Gen 2 Port (Type A)
4. AC/DC Powered USB 3.2 Gen 2 Port (Type A) (see over)
5. 2-In-1 Audio Jack (Headphone/Microphone)



2-In-1 Audio Jack

Note that 2-In-1 combination audio jacks can support headphones, microphones, or headsets (i.e. a combination microphone/headphone).

1. When a device is plugged in to the combination audio jack a dialog (“Which device did you plug in?”) box will pop-up

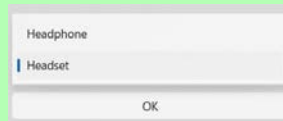

2. Make sure you select the correct device from the drop-down menu corresponding to the device plugged-in (e.g. **choose “Headset” if you have plugged-in a headset** and do not choose headphone in this case), and then click **OK** to save the setting.



Overheating

To prevent your computer from overheating make sure nothing blocks the Vent/Fan Intake while the computer is in use.



USB & Thunderbolt™ Ports

This computer model features two USB 3.2 Gen 2 Type A ports (including 1 AC/DC Powered USB Port), one Thunderbolt™ 5 port and one Thunderbolt™ 5 port with Power Delivery DC-In.

Note: The maximum amount of current supplied by the USB ports is 900 mA for USB 3.2. The maximum amount of current supplied by the Thunderbolt port is 5V/3A in AC mode or 5V/1.5A in DC mode.

Powered USB Port

Note that the powered USB 3.2 Gen 2 port (Type A) is not operational under DOS and does not support wake on USB. The **powered USB 3.2** (4 in *Figure 1 - 5 on page 1 - 15*) port can supply power (**for charging devices only, not for operating devices**) when the system is off but still powered by the AC/DC adapter plugged into a working outlet, or powered by the battery with a capacity level above 20% (this may not work with certain devices). Toggle power to this port by using **Fn + power button**.

Rear View - Model A



Figure 1 - 7
Rear View

1. Vent/Fan Intake
2. Security Lock Slot
3. HDMI-Out Port
4. RJ-45 LAN Jack
5. DC-In Jack
6. LED Light Bar (*For Model A Only*)

USB & Thunderbolt™ Ports

This computer model features two USB 3.2 Gen 2 Type A ports (including 1 AC/DC Powered USB Port), one Thunderbolt™ 5 port and one Thunderbolt™ 5 port with Power Delivery DC-In.

Note: The maximum amount of current supplied by the USB ports is 900 mA for USB 3.2. The maximum amount of current supplied by the Thunderbolt port is 5V/3A in AC mode or 5V/1.5A in DC mode.

LED Light Bar

Model A series computers feature an LED Light Bar module, and this can be configured from the Control Center (see *“Control Center” on page 1 - 14*).



Overheating

To prevent your computer from overheating make sure nothing blocks the Vent/Fan Intake while the computer is in use.

DC-In Jack

It's essential to fully plug an AC/DC adapter into the jack on the right side of the computer to ensure a secure connection and prevent issues like poor charging or an electrical short circuit (see *“Power Safety” on page I - X* of the Preface).

Figure 1 - 8
Rear View

1. Vent/Fan Intake
2. Security Lock Slot
3. HDMI-Out Port
4. RJ-45 LAN Jack
5. DC-In Jack

Rear View - Model B

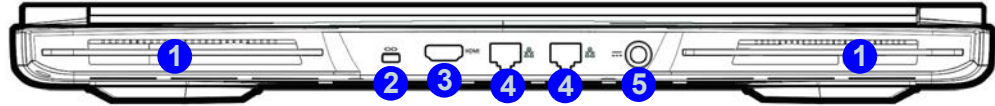

Overheating

To prevent your computer from overheating make sure nothing blocks the Vent/Fan Intake while the computer is in use.

DC-In Jack

It's essential to fully plug an AC/DC adapter into the jack on the right side of the computer to ensure a secure connection and prevent issues like poor charging or an electrical short circuit (see ["Power Safety" on page I - X](#) of the Preface).



USB & Thunderbolt™ Ports

This computer model features two USB 3.2 Gen 2 Type A ports (including 1 AC/DC Powered USB Port), one Thunderbolt™ 5 port and one Thunderbolt™ 5 port with Power Delivery DC-In.

Note: The maximum amount of current supplied by the USB ports is 900 mA for USB 3.2. The maximum amount of current supplied by the Thunderbolt port is 5V/3A in AC mode or 5V/1.5A in DC mode.

Right View - Model A

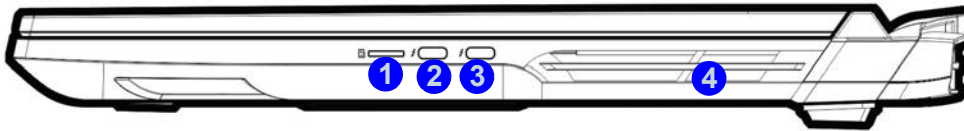

Figure 1 - 9
Right View

1. MicroSD Push-Push Card Reader
2. Thunderbolt™ 5 Port
3. Thunderbolt™ 5 Port with Power Delivery DC-In Function
4. Vent/Fan Intake

USB & Thunderbolt™ Ports

This computer model features two USB 3.2 Gen 2 Type A ports (including 1 AC/DC Powered USB Port), one Thunderbolt™ 5 port and one Thunderbolt™ 5 port with Power Delivery DC-In.

Note: The maximum amount of current supplied by the USB ports is 900 mA for USB 3.2. The maximum amount of current supplied by the Thunderbolt port is 5V/3A in AC mode or 5V/1.5A in DC mode.

Thunderbolt™ 5 Port with Power Delivery with DC-In

The Thunderbolt™ 5 port with Power Delivery DC-In Function allows you to use a power source, with a USB Type C cable, plugged into the port to charge the computer.

Make sure any power source is appropriately certified, and complies with the USB-C PD (Power Delivery) standard specification rated at 20Vdc, 5A.

MicroSD Card Reader

The card reader allows you to use microSD storage cards:

microSD / microSDHC /
microSDXC



Thunderbolt Port Devices

When plugging a device into a Thunderbolt port allow 30 seconds for the system to scan and recognize the connected device. In order to prevent system problems make sure you **do not simply pull the cable out from the Thunderbolt port**. The hardware must be ejected safely:

1. Go to the notification area of the taskbar and click on the **Safely Remove Hardware and Eject Media** icon.
2. Click on Eject "*Thunderbolt Device Name*".
3. When you see the "**Safe to Remove Hardware**" message **you can remove the cable after about 20 seconds**, to make sure that it is safe to eject the device.

The Thunderbolt™ 5 port with Power Delivery with DC-In allows you to use a power source, with a USB Type C cable, plugged into the port to charge the computer. Make sure any power source complies with the USB-C PD (Power Delivery) standard specification rated at 20Vdc, 5A or 20Vdc, 3.25A (for off mode charge).

Right View - Model B

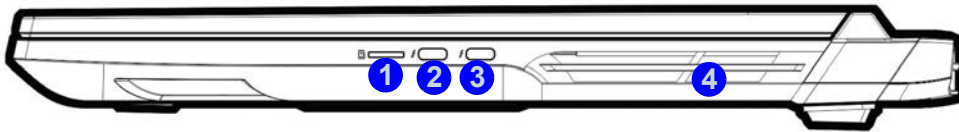

Figure 1 - 10
Right View

1. MicroSD Push-Push Card Reader
2. Thunderbolt™ 5 Port
3. Thunderbolt™ 5 Port with Power Delivery DC-In Function
4. Vent/Fan Intake

USB & Thunderbolt™ Ports

This computer model features two USB 3.2 Gen 2 Type A ports (including 1 AC/DC Powered USB Port), one Thunderbolt™ 5 port and one Thunderbolt™ 5 port with Power Delivery DC-In.

Note: The maximum amount of current supplied by the USB ports is 900 mA for USB 3.2. The maximum amount of current supplied by the Thunderbolt port is 5V/3A in AC mode or 5V/1.5A in DC mode.

Thunderbolt™ 5 Port with Power Delivery with DC-In

The Thunderbolt™ 5 port with Power Delivery DC-In Function allows you to use a power source, with a USB Type C cable, plugged into the port to charge the computer.

Make sure any power source is appropriately certified, and complies with the USB-C PD (Power Delivery) standard specification rated at 20Vdc, 5A.

MicroSD Card Reader

The card reader allows you to use microSD storage cards:

microSD / microSDHC /
microSDXC



Thunderbolt Port Devices

When plugging a device into a Thunderbolt port allow 30 seconds for the system to scan and recognize the connected device. In order to prevent system problems make sure you **do not simply pull the cable out from the Thunderbolt port**. The hardware must be ejected safely:

1. Go to the notification area of the taskbar and click on the **Safely Remove Hardware and Eject Media** icon.
2. Click on Eject "*Thunderbolt Device Name*".
3. When you see the "**Safe to Remove Hardware**" message **you can remove the cable after about 20 seconds**, to make sure that it is safe to eject the device.

The Thunderbolt™ 5 port with Power Delivery with DC-In allows you to use a power source, with a USB Type C cable, plugged into the port to charge the computer. Make sure any power source complies with the USB-C PD (Power Delivery) standard specification rated at 20Vdc, 5A or 20Vdc, 3.25A (for off mode charge).

Bottom View

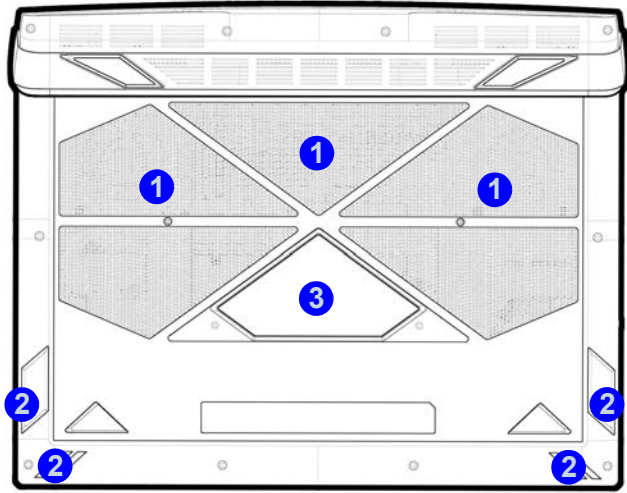



Overheating
 To prevent your computer from overheating make sure nothing blocks the Vent/Fan Intake while the computer is in use.

- Figure 1 - 11*
Bottom View
1. Vent/Fan Intake/Outlet
 2. Speakers
 3. Subwoofer

Bottom Cover Removal Warning

Do not remove any cover(s) and /or screw(s) for the purposes of device upgrade as this may violate the terms of your warranty.



If you need to replace/remove the hard disk/RAM/optical device/battery etc., for any reason, please contact your distributor/supplier for further information.

Battery Information

Always completely discharge, then fully charge, a new battery before using it. Completely discharge and charge the battery at least once every 30 days or after about 20 partial discharges.

We recommend that you do not remove the battery yourself.

Windows 11 Start Menu

Most of the apps, control panels, utilities and programs within *Windows 11* can be accessed from the **Start Menu** by clicking the icon  in the taskbar at the bottom the screen (or by pressing the **Windows Logo Key**  on the keyboard). The Start Menu will contain a number of apps, and many more will be installed as you add more applications etc. Not all of these apps may fit on the screen so you can use the scroll bar to move up and down the screen.



Windows Screens

Note that the *Windows* screens on the following pages are included as a basic guide and introduction to navigating around *Windows 11*.

However note that these screens are always subject to change, upgrade and redesign. Check the Microsoft website for details.

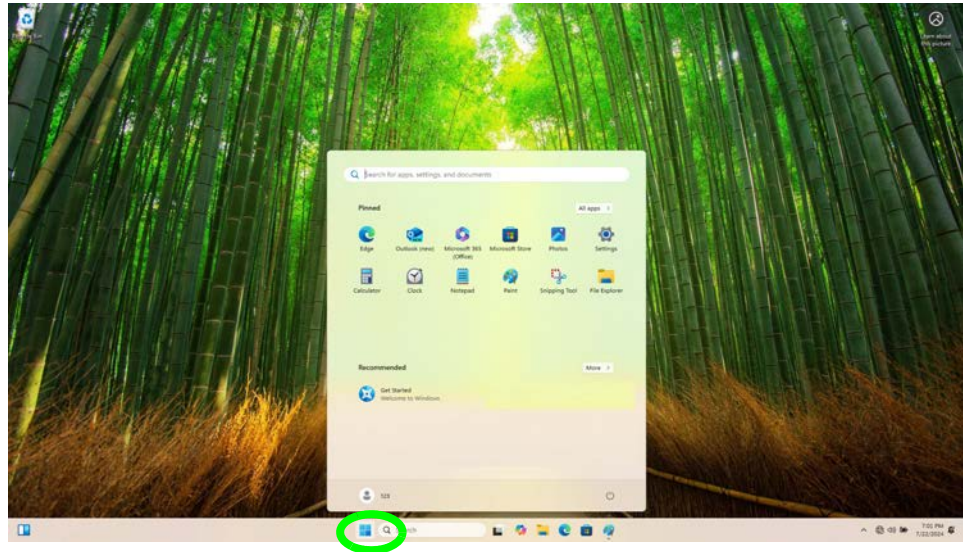



Figure 1 - 12 - Windows Start Menu

Right-Clicking the Windows Logo In Start Menu

Right-click the Start Menu  icon (or use the **Windows Logo Key**  + **X** key combination) to bring up an advanced **Context Menu** of useful features such as Apps and Features, Power Options, Task Manager, Search, File Explorer, Device Manager, Computer Management and Network Connections etc.

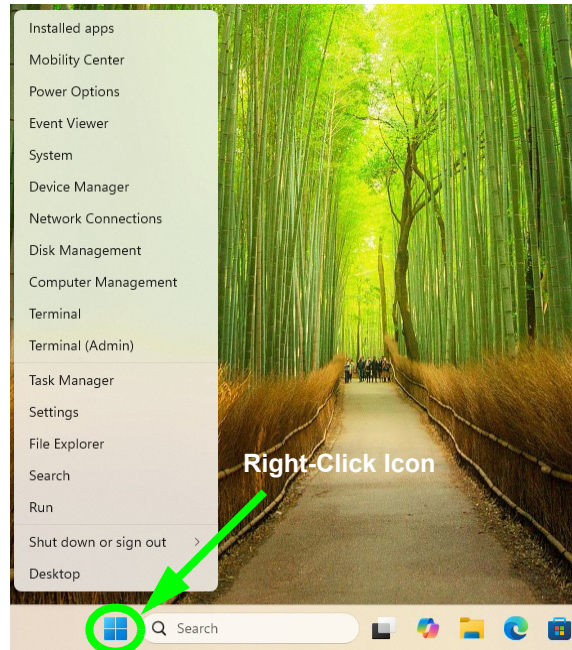

Figure 1 - 13 - Right-Click Windows Logo in Start Menu

Quick Start Guide

Pining/Unpinning Apps & Programs to/from the Start Menu

To make things easy to find you can add and remove tiles for apps and programs to the Start Menu. Right-Click on a program's icon and select **Pin to Start** from the drop-down menu. To remove an app or program from the Start Menu right-click the icon and select **Unpin from Start**. You can use the same method to **pin apps/programs to/from the taskbar** (select pin to taskbar/unpin this program from the taskbar).

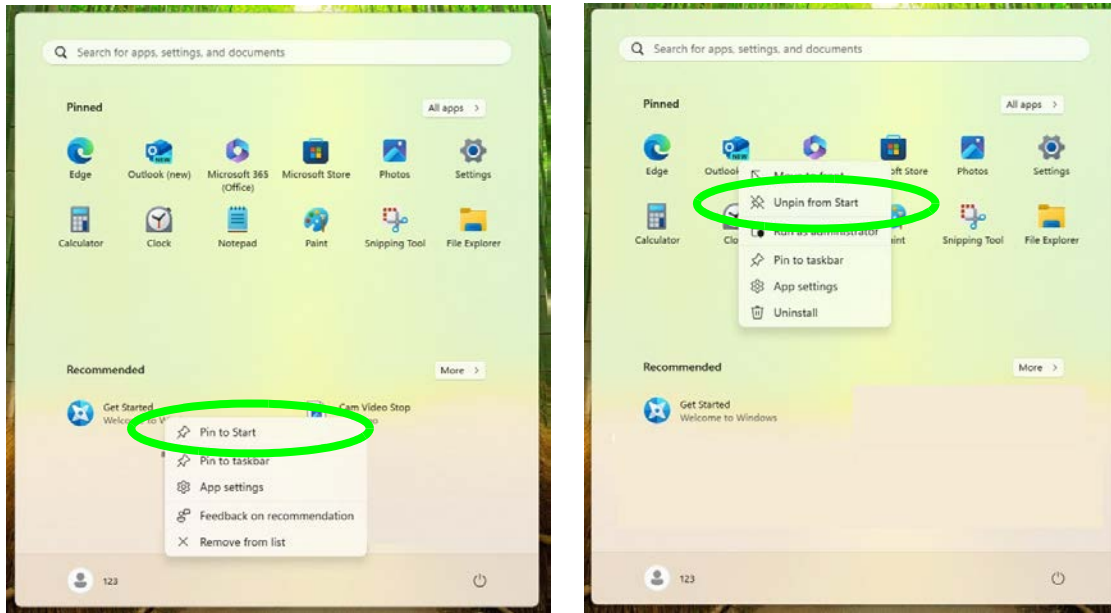

Figure 1 - 14 - Pin to Start/Unpin from Start

Windows 11 Control Panel

In many instances throughout this manual you will see an instruction to open the **Control Panel**. The Control Panel can be accessed in a number of ways in *Windows 11*.

- Use the *Windows Logo Key* **⊞** + *R* key combination and type “*Control Panel*”.
- Type “*Control Panel*” into the *Search* box in the taskbar and click on the icon when it pops up.
- You can pin the *Control Panel* tile to *Start* or *taskbar*.

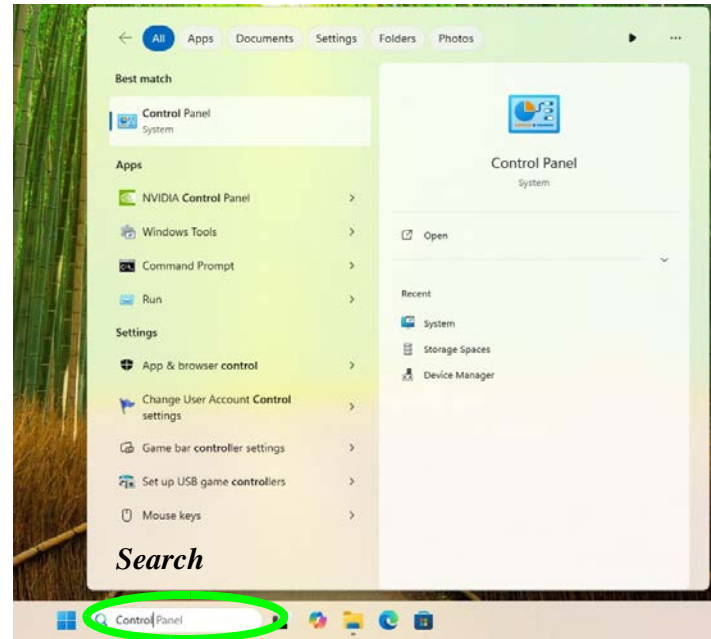
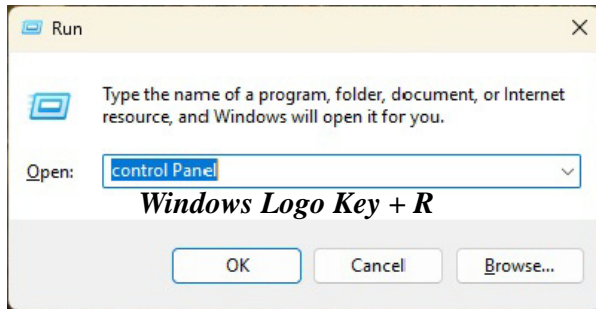

Figure 1 - 15 - Windows 11 Control Panel Access

Windows 11 Settings

The **Settings** item in the Start Menu (and also as an app) gives you quick access to a number of system settings control panels allowing you to adjust settings for System, Bluetooth & devices, Network & internet, Personalization, Apps, Accounts, Time & language, Gaming, Accessibility, Privacy & security and Windows Update.

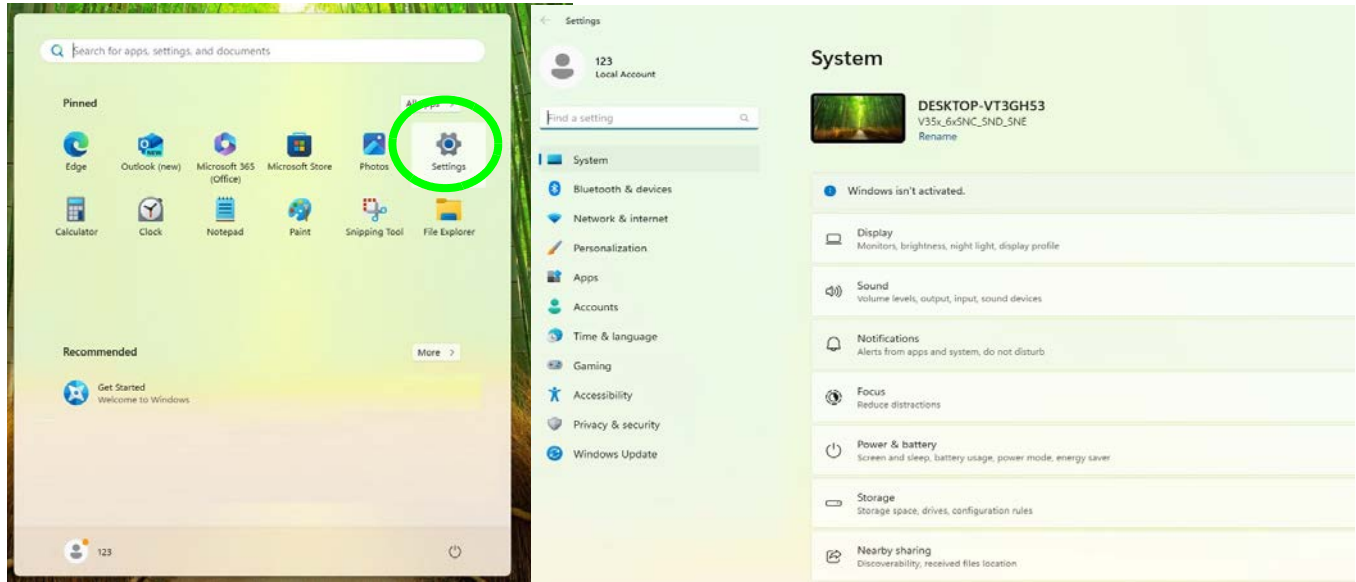

Figure 1 - 16 - Settings

Windows 11 Taskbar

In many instances throughout this manual you will see an instruction to access the **notification area of the taskbar**. The notification area of the taskbar is in the bottom right of the screen. Some of the Control Panels and applications referred to throughout the course of this manual can be accessed from here.

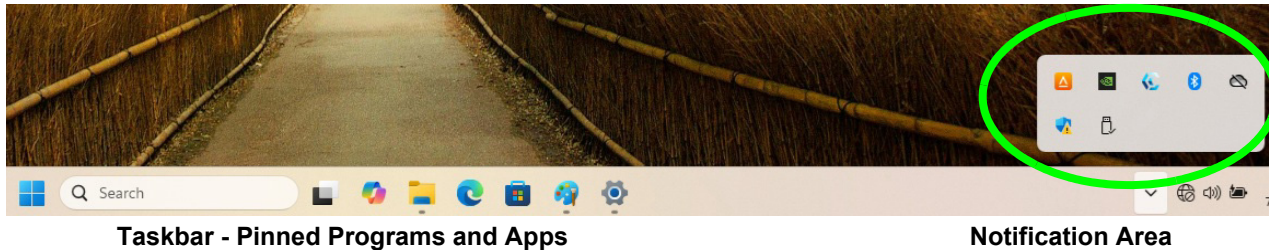



Figure 1 - 17 - Taskbar

You can pin/unpin apps to/from the taskbar in much the same way as you can to the Start screen (see *[“Pining/Unpinning Apps & Programs to/from the Start Menu”](#)* on page 1 - 28).

Windows 11 Action Center

The **Action Center** appears as a panel on the right side of the screen when you click the battery icon  (or use the **Windows Logo Key**  + **A** key combination in the notification tray). This gives you access to commonly needed functions like Network, All Settings, Airplane Mode, Bluetooth, Brightness and Volume etc.

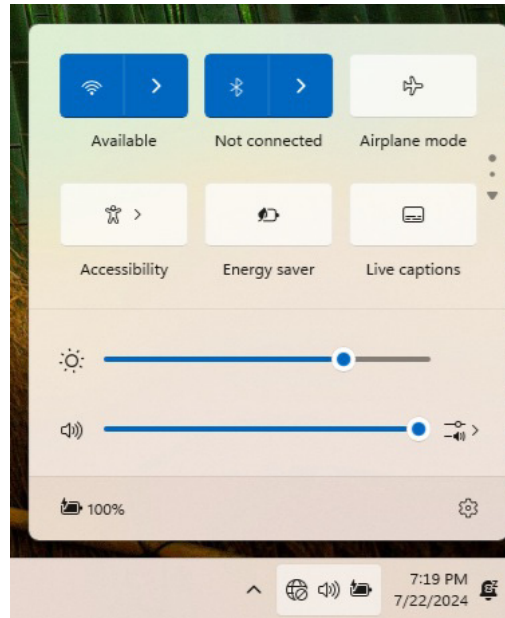

Figure 1 - 18 - Action Center

Video Features

You can switch display devices, and configure display options, from the **Display settings** (click the **Start Menu** and click **Settings > System** or right-click the desktop and select **Display settings**) control panel (see page [1 - 35](#)). In **Windows** it is possible to quickly configure external displays from the **Project** menu (press the Windows logo key **⊞** on your keyboard and the **P** key or **Fn + F7**).

To Configure Displays using Project:

1. Attach your display to the appropriate port, and turn it on.
2. Press the **⊞ + P** (or **Fn + F7**) key combination.
3. Click on any one of the options from the menu to select **PC screen only**, **Duplicate**, **Extend** or **Second screen only**.
4. Press the **⊞ + K** key combination, or, go to the **Display settings** menu and select **Connect to a wireless display** and then click **Connect**.

Figure 1 - 19 - Project (Devices)

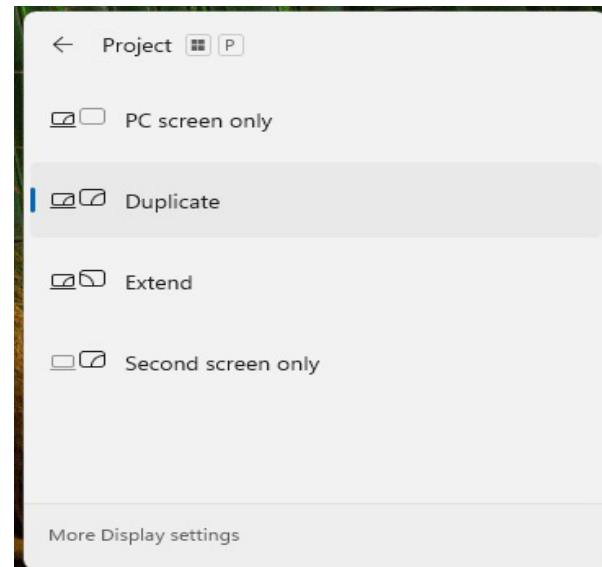

NVIDIA Advanced Optimus Capable Technology

Most notebook computers come with either a **discrete** or **integrated** graphics solution. The system features both an Intel's Integrated GPU (for power-saving) and an NVIDIA's discrete GPU (for performance). You can switch display devices, and configured display options as long as the video drivers are installed.

Discrete graphics solutions feature a dedicated Graphics Processing Unit (GPU) which are capable of playing games, watching HD video or running GPU-based applications. However computers with discrete graphics solutions tend to be heavy in power consumption, and slightly larger in size in order to incorporate the dedicated discrete GPU.

Integrated graphics solutions usually feature memory sharing technology to help save power consumption and allow for longer battery life. However computers with integrated graphics solutions will not usually run games, HD video or GPU-based applications without severe limitations.

How Switchable Technology works

When the system is powered up and is displaying just the desktop, the dGPU will be powered off. In this case the system is running in the same way as a system without a discrete graphics solution. However when an application that requires use of the dGPU is run (e.g, a game or HD Video), the dGPU is powered on and takes over the processing duties. If the program is closed, then the dGPU will be powered back down again until required.

NVIDIA Advanced Optimus

(For G-SYNC systems)

Note that systems with **G-Sync** displays support **Advanced Optimus** modes which feature **Dynamic Display Switching**. Advanced Optimus allows dynamically switching across different display adapters and this offers longer battery life, along with the performance and benefits of G-Sync and high refresh rate.

To access the Display Settings:

1. You can quickly adjust the display by right-clicking the desktop and selecting **Display Settings**.
2. Adjust the settings for **Brightness, HDR, Scale, Display resolution** and **orientation** from the menus.
3. When an external display is attached you can arrange the display configuration from **Duplicate these displays** menu.

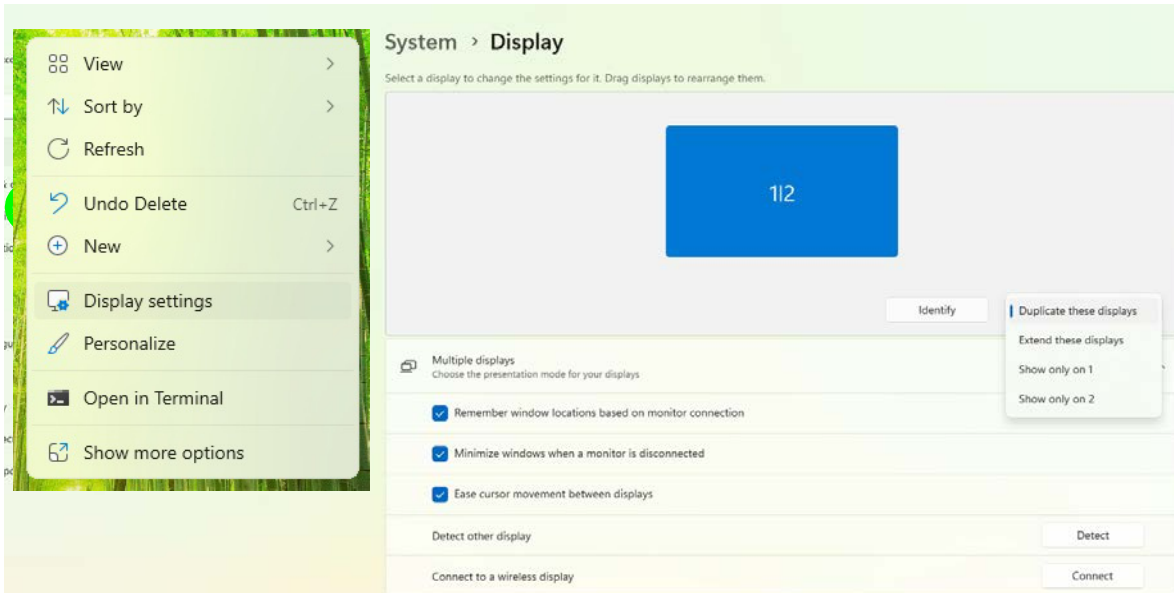

Figure 1 - 20 - Display Settings

Quick Start Guide

To access the *Intel(R) Graphics Command Center*:

1. Access the **Intel Graphics Command Center** from the **Start** menu in **Windows** (click **All apps** and scroll down to **Intel Graphics Command Center**).
2. You can **right-click** the **Intel Graphics Command Center** in the Start menu and pin the control panel to Start and/or taskbar.

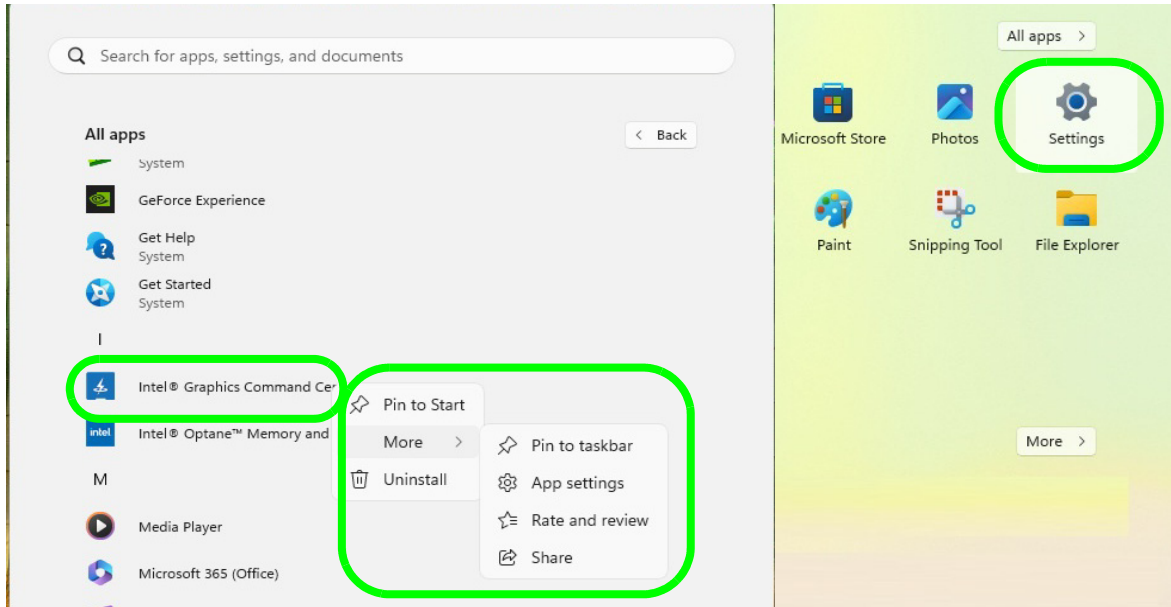

Figure 1 - 21 - Intel® Graphics Command Center Access

Advanced video configuration options are provided by the **Intel Graphics Command Center**.

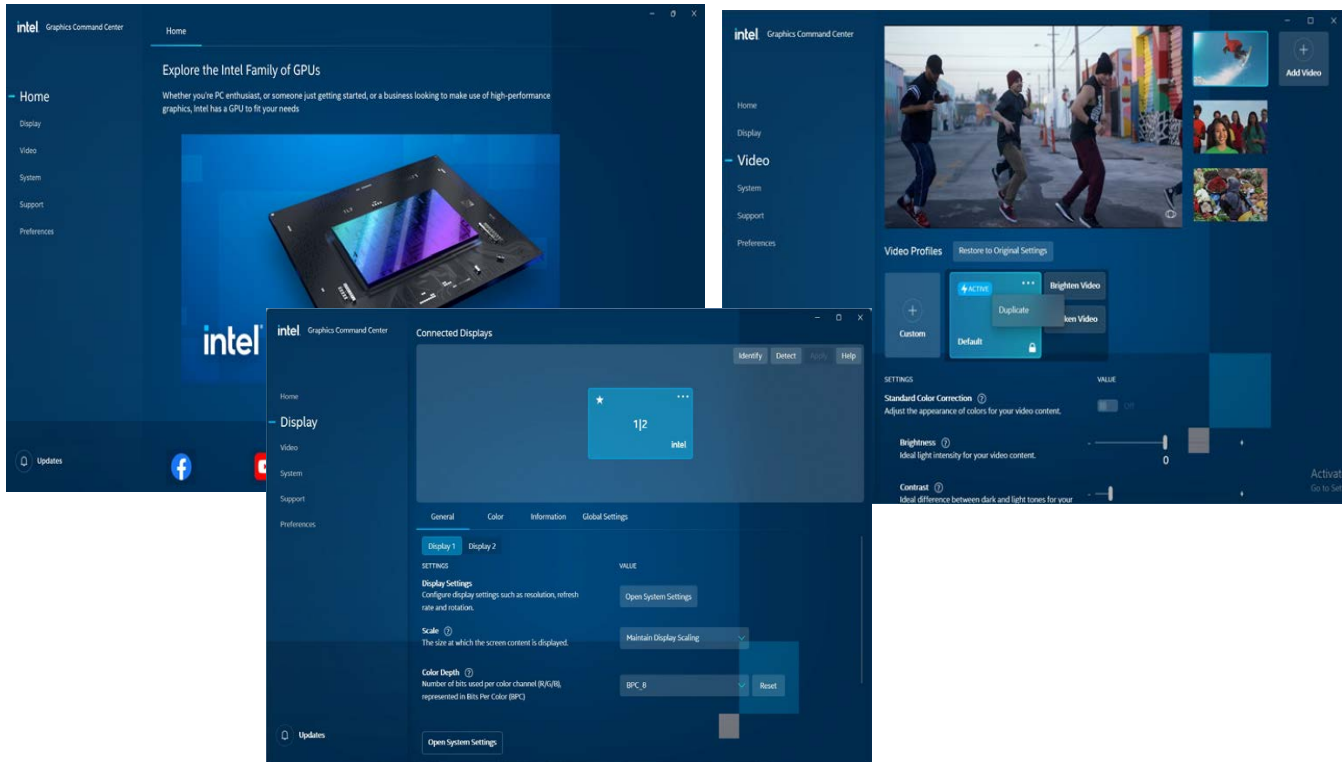

Figure 1 - 22 - Intel® Graphics Command Center

Quick Start Guide

To access the *NVIDIA Control Panel*:

1. Access the **NVIDIA Control Panel** from the **Start** menu in **Windows** (click **All apps** and scroll down to **NVIDIA Control Panel**).
2. You can **right-click** the **NVIDIA Control Panel** in the Start menu and pin the control panel to Start and/or taskbar.

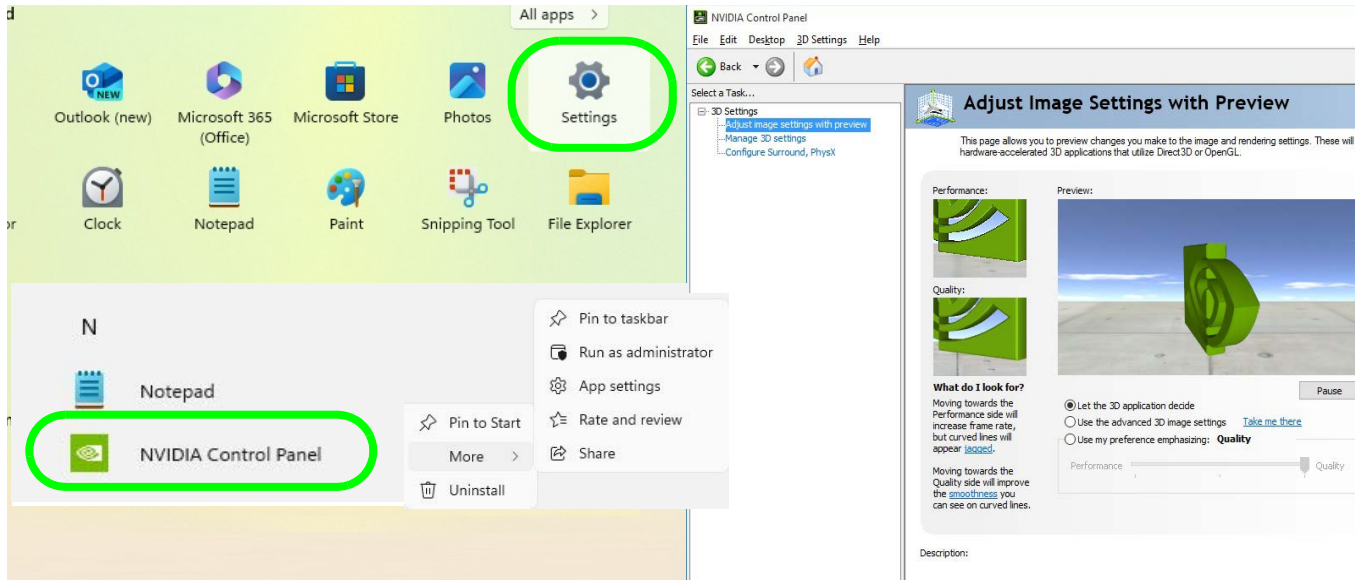

Figure 1 - 23 - NVIDIA Control Panel

Minimum Screen Resolution Settings

1. **Windows 11** has minimum screen resolution requirements.
2. Right-click a blank area of the Desktop and select **Display Settings**.
3. Adjust the **Display resolution** to make sure that it is at least **1024 * 768**, although preferably **1366 * 768** or above.

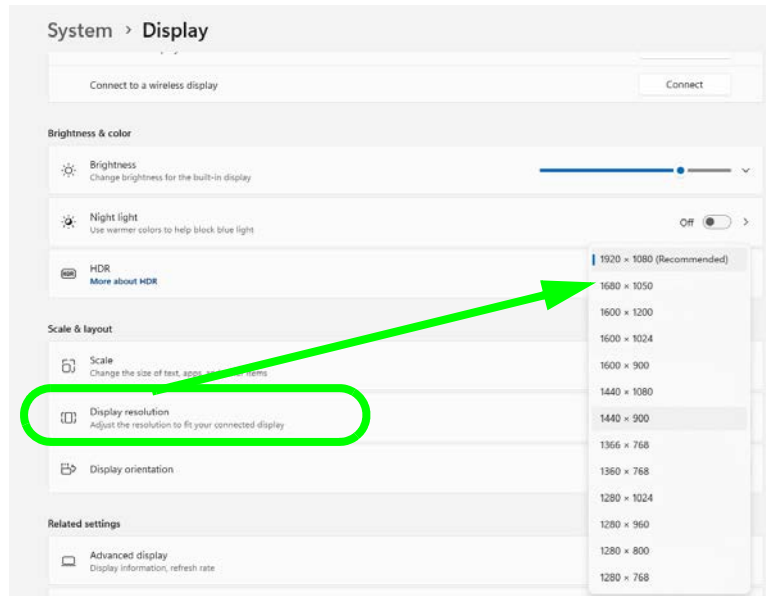

Figure 1 - 24 - Display (Resolution)

Power Options

The **Power** button item in **Start Menu** (or the context menu) may be used to **Shut down** or **Restart** (you can also add **Hibernate/Sleep** to the menu - see page [1 - 41](#)). The **Power & battery** menu in **Settings** (system) can be used for power configuration. To fully control all the power options (including Hibernate mode) go to the **Power Options control panel** and configure the power button, sleep button and lid to perform the function selected.

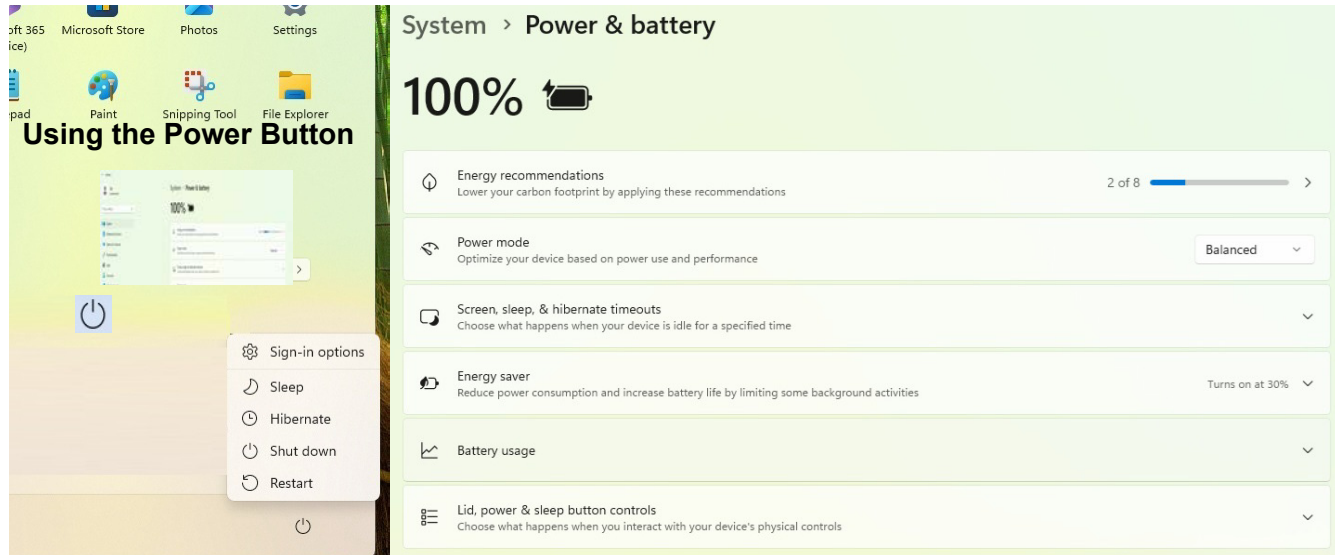



Figure 1 - 25 - Shut Down/Restart & Settings (System) Power & Battery

You can also use the **context menu** (right-click the Start Menu  icon or press the **Windows logo**  + X key combination) to **Sign out, Sleep, Hibernate, Shut down, and Restart**.

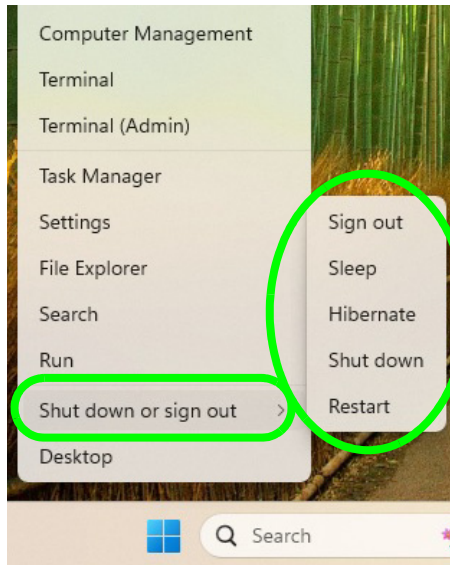
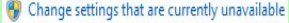

Figure 1 - 26 - Context Menu Shut Down or sign out

Ctrl + Alt + Delete Key Combination

You can use the **CTRL + ALT + DEL** key combination to bring up a full-screen displaying **Lock, Switch User, Sign out, Change a password and Task Manager**. If you click the **Power** icon in the lower right corner of the screen a power management option menu appears to display **Sleep, Hibernate, Shut down, and Restart**.

Adding Hibernate/Sleep to the Power Menu

1. Go to the **Power Options (Hardware and Sound)** control panel (see *“Windows 11 Control Panel” on page 1 - 29*).
2. Click **Choose what the power buttons do**.
3. Click **“Change settings that are currently unavailable”**

4. Click to put a check in the **Hibernate/Sleep** box under **Shutdown settings**.
5. Click **Save Changes** and close the control panel.

Resuming Operation From Power-Saving

You can resume operation from power-saving states by pressing any keyboard key (if the system is in **Sleep**), the power button, or in some cases pressing the sleep button (Fn + F12 key combo).

Chapter 2: Features & Components

Overview

Read this chapter to learn more about the following main features and components of the computer:

- Solid State Drive
- MicroSD Push-Push Card Reader
- Clickpad and Buttons/Mouse
- Realtek Audio Console



Bottom Cover Removal Warning

Do not remove any cover(s) and /or screw(s) for the purposes of device upgrade as this may violate the terms of your warranty.

If you need to replace/remove the hard disk for any reason, please contact your distributor/supplier for further information.

Solid State Drive

The solid state drive (SSD) is used to store your data in the computer. The SSD can be taken out to accommodate other PCIE SSDs, however you will need to contact your distributor/supplier to do this in order to avoid violating the terms of your warranty (see *“Storage” on page C - 2* for specification information).

MicroSD Push-Push Card Reader

The card reader allows you to use microSD storage cards. Push the card into the slot and it will appear as a removable device, and can be accessed in the same way as your hard disk (s). Make sure you install the card reader driver (see “*CardReader*” on page 4 - 9).

The compatible microSD card formats are listed below:

- microSD / microSDHC / microSDXC

Model A

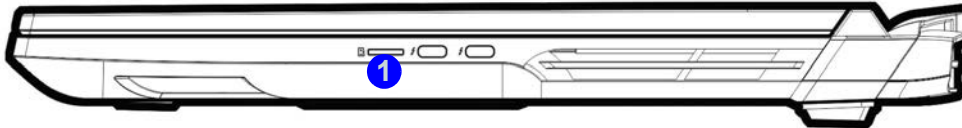

Model B

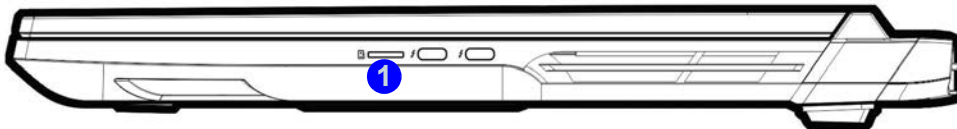

Push-Push Card Reader

The card reader features a push-in/push-out card insertion and ejection mechanism. Simply push the card to insert and eject it.

1. Card Reader

Figure 2 - 1
Left View



Clickpad Cleaning

In order to improve pad performance it is necessary to keep the surface clean and free of fingerprints and marks etc.

Use a soft dry cleaning cloth to keep the pad surface clean.

Disabling the Pad

Use the **Fn + F1** or Control Center button to disable the Clickpad.

Figure 2 - 2
Clickpad Zones

Clickpad and Buttons/Mouse

The Clickpad is an alternative to the mouse; however, you can also add a mouse to your computer through one of the USB ports. The Clickpad buttons function in much the same way as a two-button mouse (*note the terms **Clickpad and Touchpad are interchangeable throughout this manual***).

Touchpad Sensitivity

The **mouse button zones** at the bottom of the pad are defined by the line at the **bottom** of the pad, and the **left and right buttons** are divided roughly down the middle. Press the left button zone for a left click, and right button zone for a right click action.

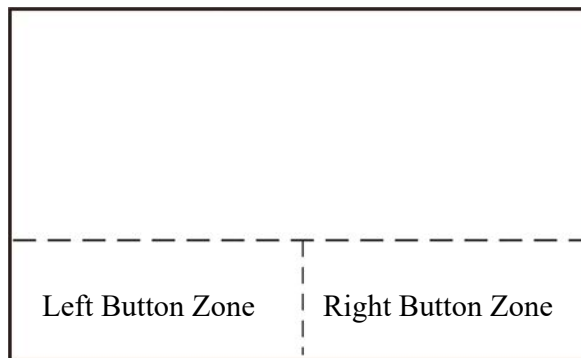

Mouse Driver

If you are using an external mouse your operating system may be able to auto-configure your mouse during its installation or only enable its basic functions. Be sure to check the device's user documentation for details.

Mouse Properties Control Panel

You can configure the functions from the **Mouse** control panel in *Windows* as follows.

1. Click the **Settings** item in the **Start Menu** (or **All Settings** in the Action Center).
2. Click **Bluetooth & Devices**.
3. Click **Mouse**.
4. Click **Additional mouse settings**.

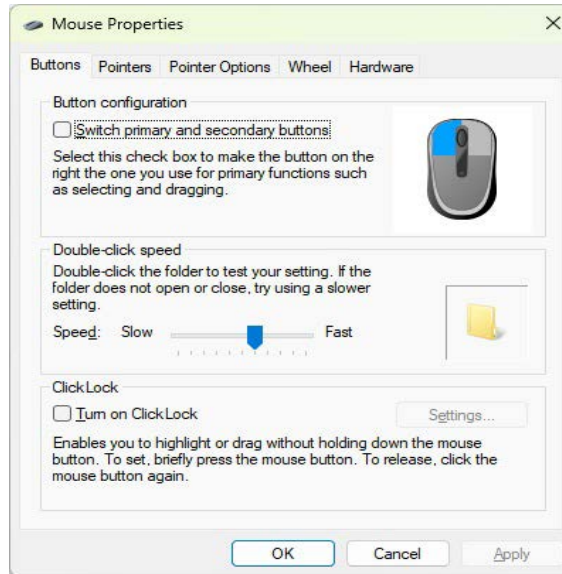

Disabling the Clickpad

If you need to disable the Clickpad for any reason (e.g. you may find that when using the computer's internal keyboard you accidentally trigger the Clickpad when resting your wrists or palms on it) you can do so by using **Fn + F1** key combination.

Figure 2 - 3
Mouse Properties Control Panel - Buttons

Figure 2 - 4
Mouse Properties
Control Panels

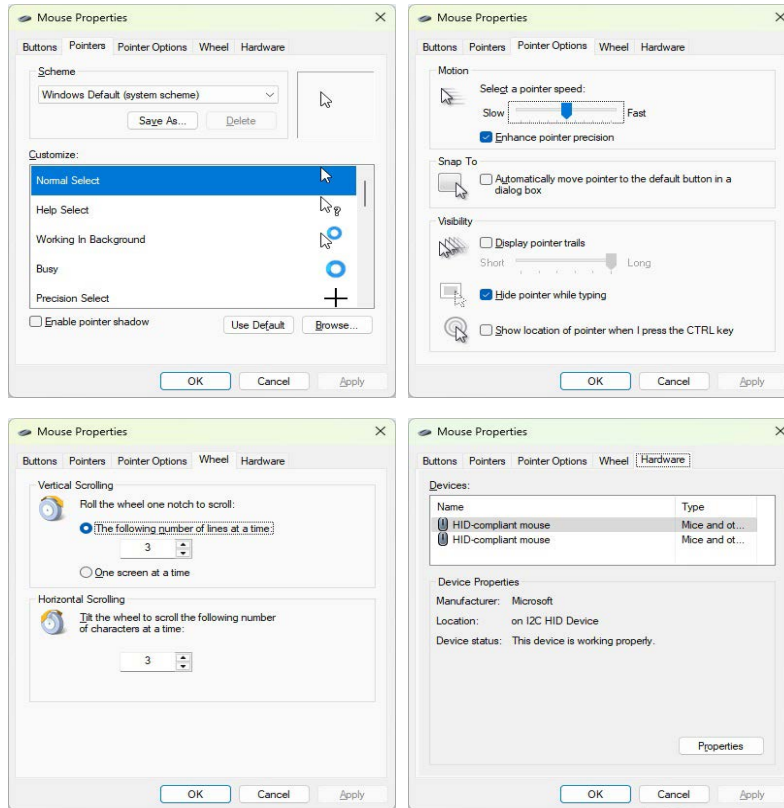

Mouse & Touchpad Devices

You can configure the functions from the **Mouse or Touchpad** control panels in *Devices* in the *Settings* control panel as follows.

1. Click the **Settings** item in the **Start Menu** (or **All Settings** in the Action Center).
2. Click **Bluetooth & Devices**.
3. Click **Mouse** or **Touchpad**.

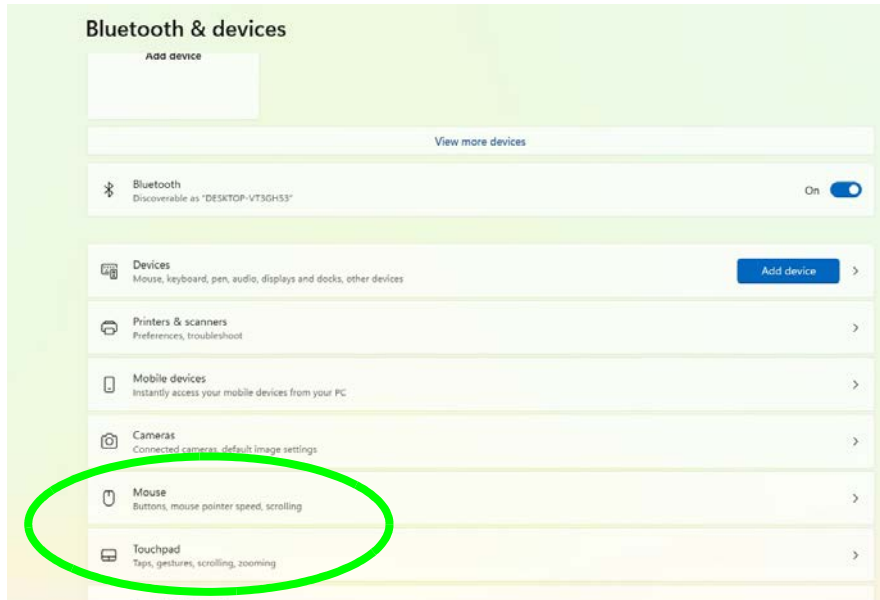

Figure 2 - 5
Windows Settings
> Mouse/Touchpad

Mouse Settings

You can select the primary mouse button and scrolling options and access Mouse Properties from **Additional mouse settings**.

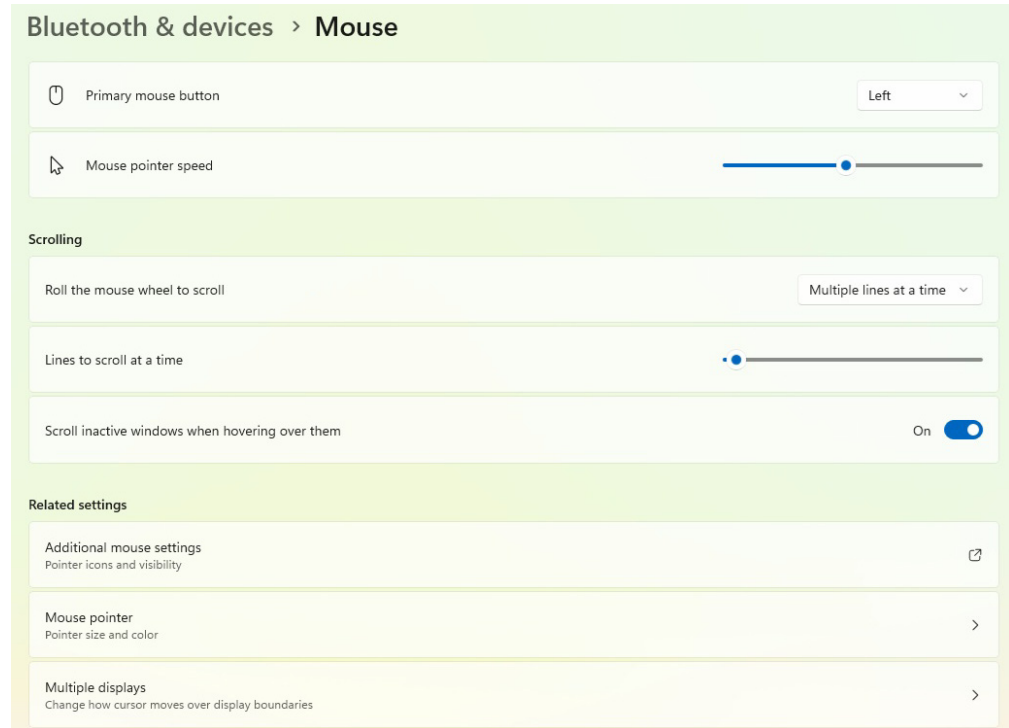

Figure 2 - 6
Windows Settings
Mouse

Touchpad Settings

You can disable the Touchpad by clicking the Touchpad button to turn it off.

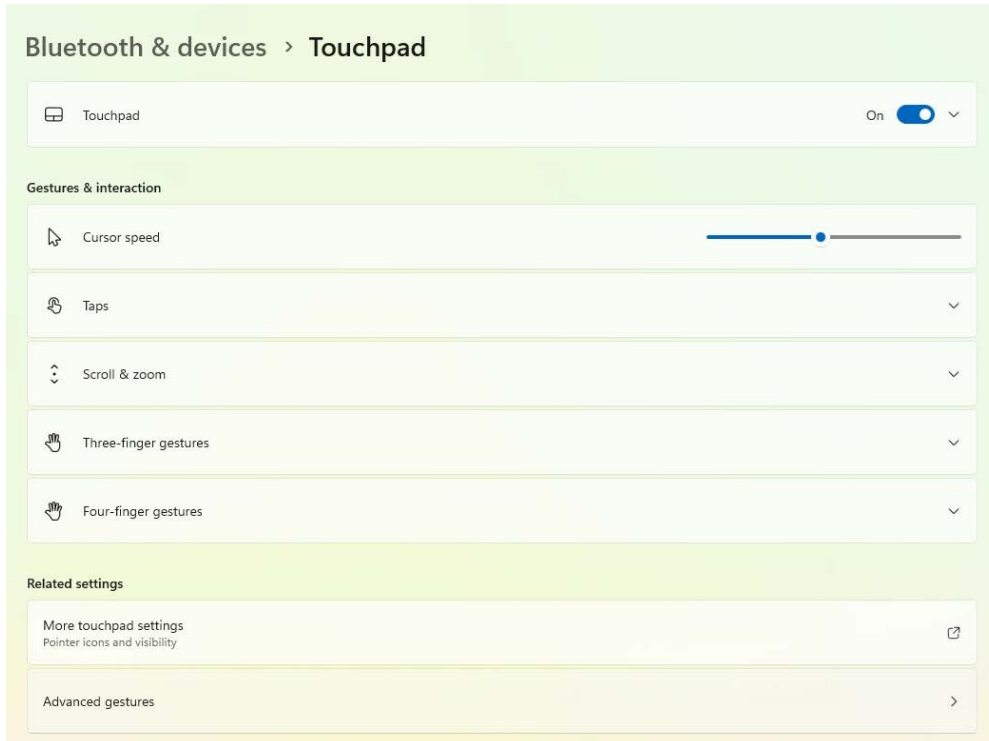

Figure 2 - 7
Windows Settings
Touchpad

Touchpad Taps

The **Touchpad Sensitivity** feature helps prevent recognizing taps on the pad by accident, by recognizing when your palm is resting on it or brushing its surface while you are typing.

Click in the check box to enable/disable the different gestures or taps on the surface of the pad to perform specific actions to manipulate documents, objects and applications.

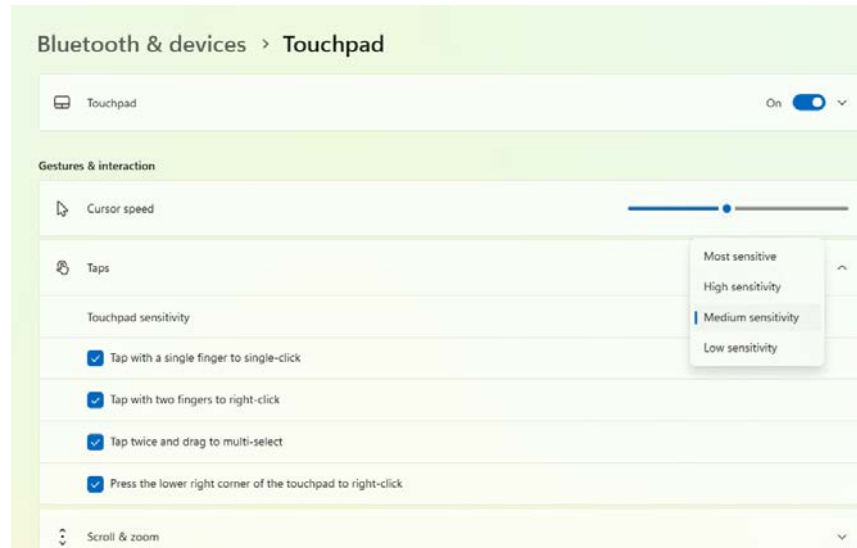

Figure 2 - 8
**Windows Settings
Touchpad
Sensitivity & Taps**

Touchpad Scroll and Zoom

Click to enable/disable the **two finger scrolling** and **pinch zooming** gesture.

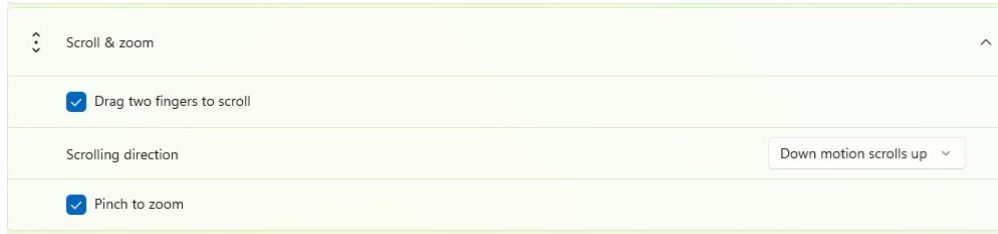

Figure 2 - 9
**Scroll and Zoom/
Scrolling Gesture**

The **two-finger scrolling** feature works in most scrollable windows and allows you to scroll horizontally and vertically. Place two fingers, slightly separated, on the Touchpad surface and slide both fingers in the direction required (in a straight continuous motion).

The **two-finger pinch to zoom** gesture can be used to perform the same function as a scroll wheel in *Windows* applications that support CTRL + scroll wheel zoom functionality. Place two fingers on the pad (for best results use the tips of the fingers) and slide them apart to zoom in, or closer together to zoom out.



Figure 2 - 10
Zooming Gesture

Features & Components

2

The **three-finger** and **four-finger swipes** and **taps** can be configured for a number of different functions. Select the appropriate function from the drop-down menu.

Figure 2 - 11
Three-Finger Gestures (Swipes & Taps)

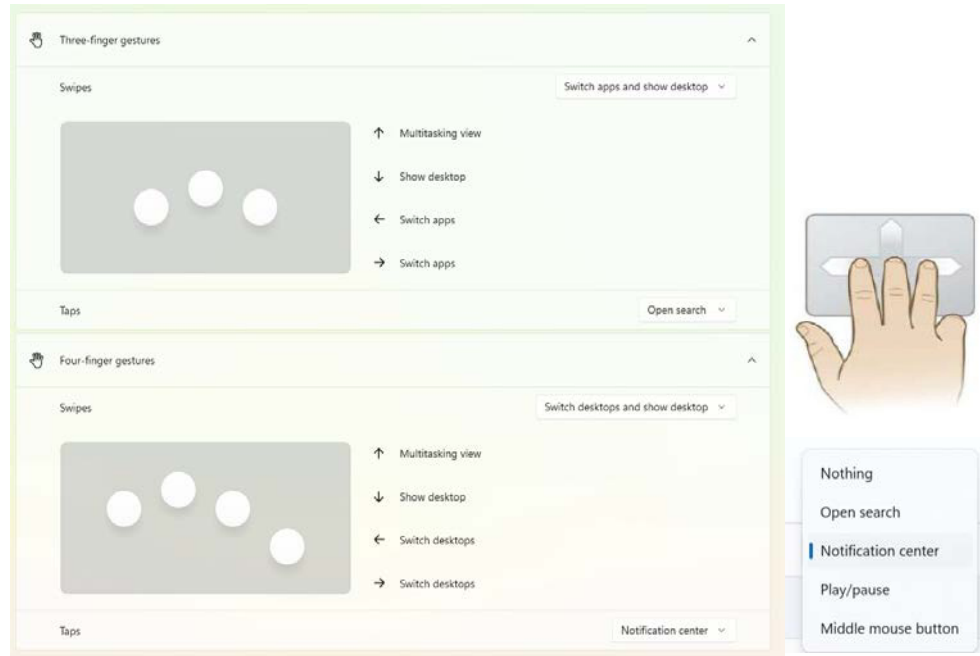

Figure 2 - 12
Four-Finger Gestures (Swipes & Taps)

The following is an overview of some of the main gestures you can use with your Touchpad, however these can be configured from the Touchpad menus.

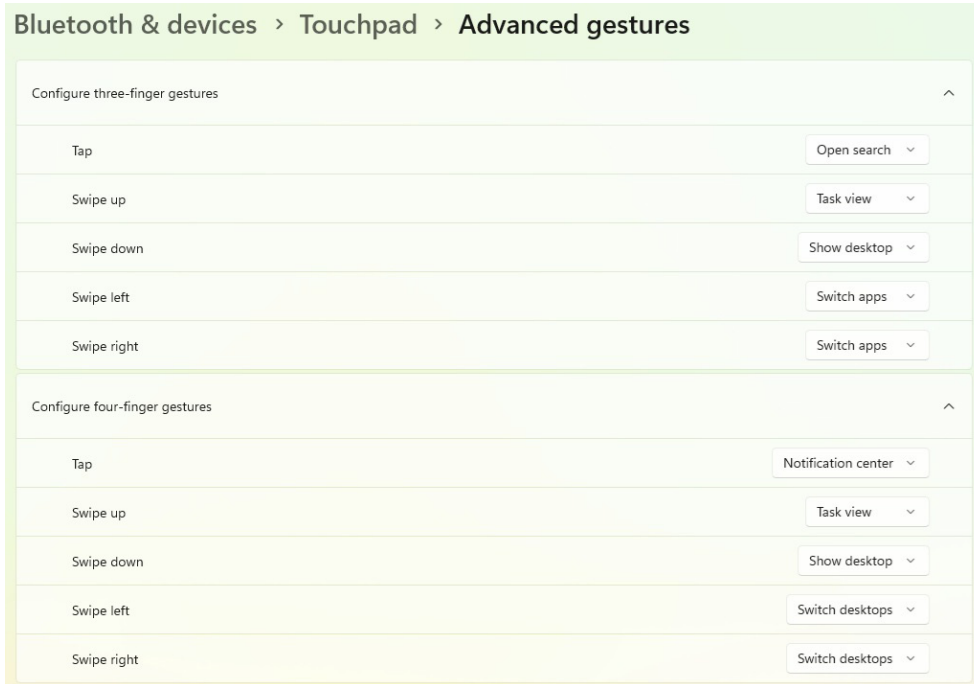

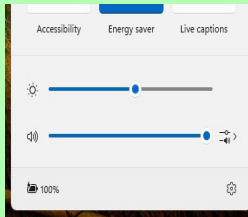

Figure 2 - 13
**Touchpad
Advanced
Gestures**



Volume Adjustment

The sound volume level can be adjusted from the **Action Center** in Windows by clicking the battery icon  (or use the **Windows Logo Key**  + **A** key combination) in the notification tray.



Realtek Audio Console

You can configure the audio options on your computer from the **Sound**  control panel in *Windows*, or from the **Realtek Audio Console Windows Start menu** (click **All apps** and scroll down to **Realtek Audio Console**). **Make sure you have installed the driver and checked the Microsoft Store for updates** (see *“Audio” on page 4 - 10*). The volume may also be adjusted by means of the **volume icon in the Action Center or the audio slider in the Settings menu** (see sidebar).

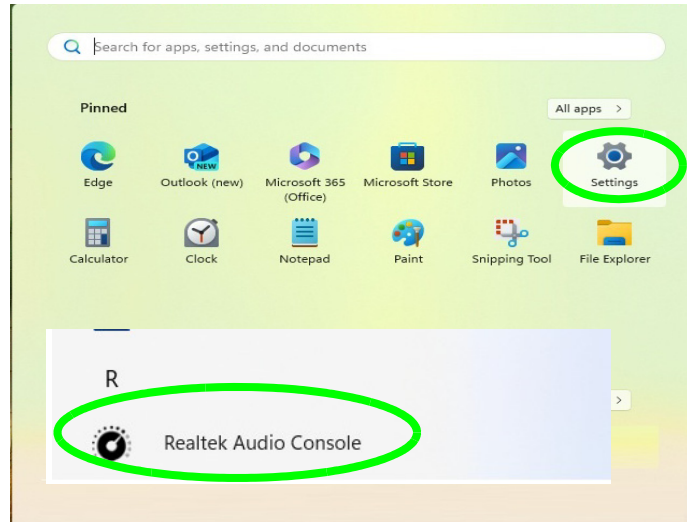

Figure 2 - 14
All Apps > Realtek Audio Console

Realtek Audio Console - Main

You can adjust the **Speaker** and **Microphone** levels by using the sliders in the **Realtek Audio Console Main** window.

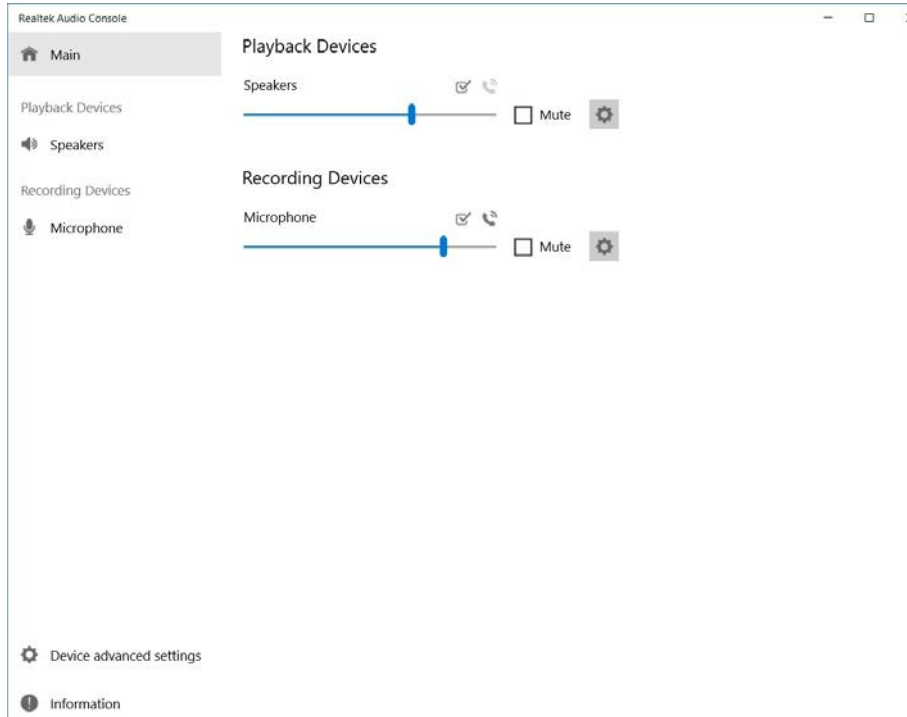
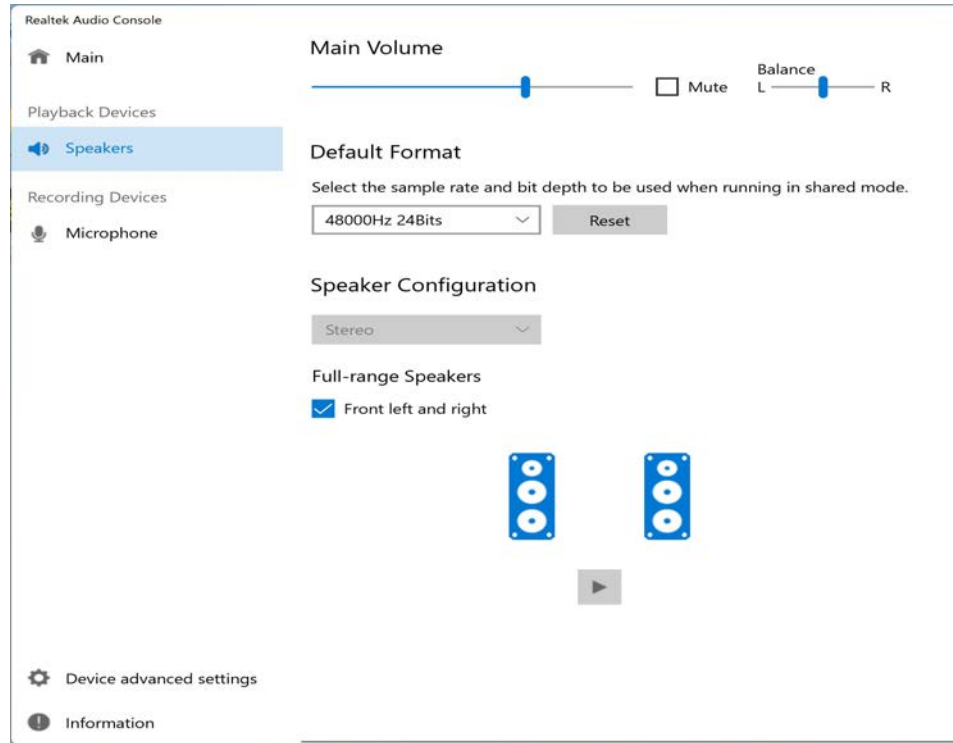

Figure 2 - 15
Realtek Audio Console (Main)

Realtek Audio Console - Speakers

Click **Speakers** to access controls for the format and speaker balance etc.

Figure 2 - 16
Realtek Audio
Console
(Speakers)



Realtek Audio Console - Microphone

Click **Microphone** to access advanced controls for recording on the microphone. Adjust the recording **Main Volume** level to around **60**, to obtain the optimum recording quality. .

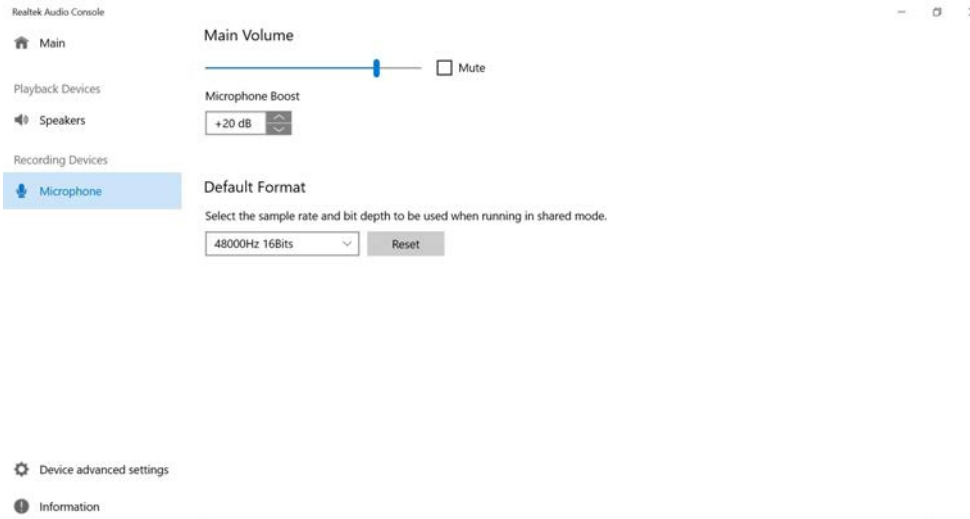

Figure 2 - 17
Realtek Audio Console (Microphone)

Realtek Audio Console - Device Advanced Settings

Device Advanced Settings allows for further configuration of the **Connector** and **Recording Device**.

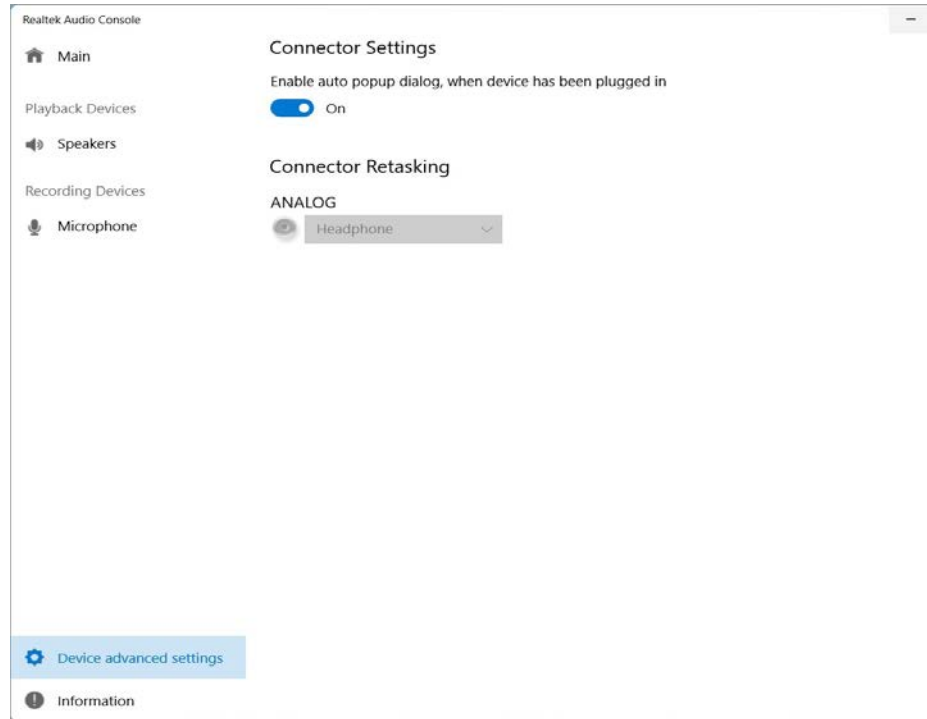

Figure 2 - 18
Realtek Audio Console - Device Advanced Settings

Chapter 3: Power Management

Overview

To conserve power, especially when using the battery, your computer power management conserves power by controlling individual components of the computer (the monitor and hard disk drive) or the whole system. This chapter covers:

- The Power Sources
- Turning On the Computer
- Shutting the Computer Down
- Settings Menu Power Controls
- Power Plans
- Power-Saving States
- Configuring the Power Buttons
- Battery Information

The computer uses enhanced power saving techniques to give the operating system (OS) direct control over the power and thermal states of devices and processors. For example, this enables the OS to set devices into low-power states based on user settings and information from applications.



OS Note

Power management functions will vary slightly depending on your operating system. For more information it is best to refer to the user's manual of your operating system.



Forced Off

If the system “hangs”, and the **Ctrl + Alt + Del** key combination doesn’t work, press the power button for **4 seconds**, or longer, to force the system to turn itself off.

The Power Sources

The computer can be powered by either an AC/DC adapter or a battery pack.

AC/DC Adapter

Use only the AC/DC adapter that comes with your computer. The wrong type of AC/DC adapter will damage the computer and its components.

1. **When first setting up the computer use the following procedure** (as to safeguard the computer during shipping, the battery will be locked to not power the system until first connected to the AC/DC adapter and initially set up as below):
 - Fully insert the AC/DC adapter cord into the DC-In jack at the rear of the computer, then plug the AC power cord into an outlet, and connect the AC power cord to the AC/DC adapter and the battery will now be unlocked.
2. Keep the AC/DC adapter connected to the computer to fully charge the battery to 100% capacity (the battery LED indicator will turn green)
3. Raise the lid/LCD to a comfortable viewing angle.
4. Press the power button to turn “On”.



DC-In Jack

It’s essential to fully plug the AC/DC adapter into the jack on the right side of the computer to ensure a secure connection and prevent issues like poor charging or an electrical short circuit (see **“Power Safety”** on page X of the Preface).

Battery

The battery allows you to use your computer while you are on the road or when an electrical outlet is unavailable. Battery life varies depending on the applications and the configuration you're using. **To increase battery life, let the battery discharge completely before recharging** (see *“Battery FAQ” on page 3 - 24*).

We recommend that you do not remove the battery. For more information on the battery, please refer to *“Battery Information” on page 3 - 19*.



Power Button

Note that for the power button to function the lid/LCD must be open.

Turning On the Computer

Now you are ready to begin using your computer. To turn it on simply press the power button on the front panel.

When the computer is on, you can use the power button as a Stand by/Hibernate/Shutdown hot-key button when it is pressed for less than **4 seconds** (pressing and holding the power button for longer than this will shut the computer down). Use **Power Options (Hardware and Sound)** in the *Windows* control panel to configure this feature.





Power Button as Stand by or Hibernate Button

You can use the OS's "Power Options" control panel to set the power button to send the system into Stand by or Hibernate mode (see your OS's documentation, or "[Configuring the Power Buttons](#)" on page 3 - 15 for details).

Shutting the Computer Down

Note that you should always shut your computer down by choosing the **Shut down** command as this will help prevent hard disk or system problems. Use the **Power**  item in the **Start Menu** and select **Shut down**.

You can also use the **context menu** (**right-click** the Start Menu  icon or press the Windows logo  + **X** key combination) to **Sign out**, **Sleep**, **Hibernate**, **Shut down**, and **Restart**.

If you want to add Hibernate/Sleep to the Power Menu see *“Adding Hibernate/Sleep (Modern Standby) to the Power Menu” on page 3 - 16.*

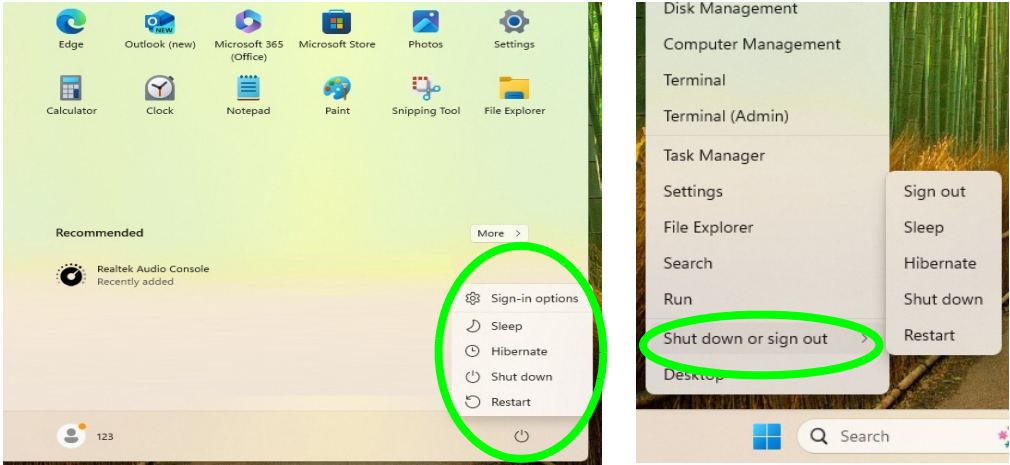



Figure 3 - 1
Shut Down/Restart

Settings Menu Power Controls

Access the **Power & battery** control panel via the **Settings (System > Power & battery)** item in the **Start Menu** (or via the battery icon  in the **Action Center**).

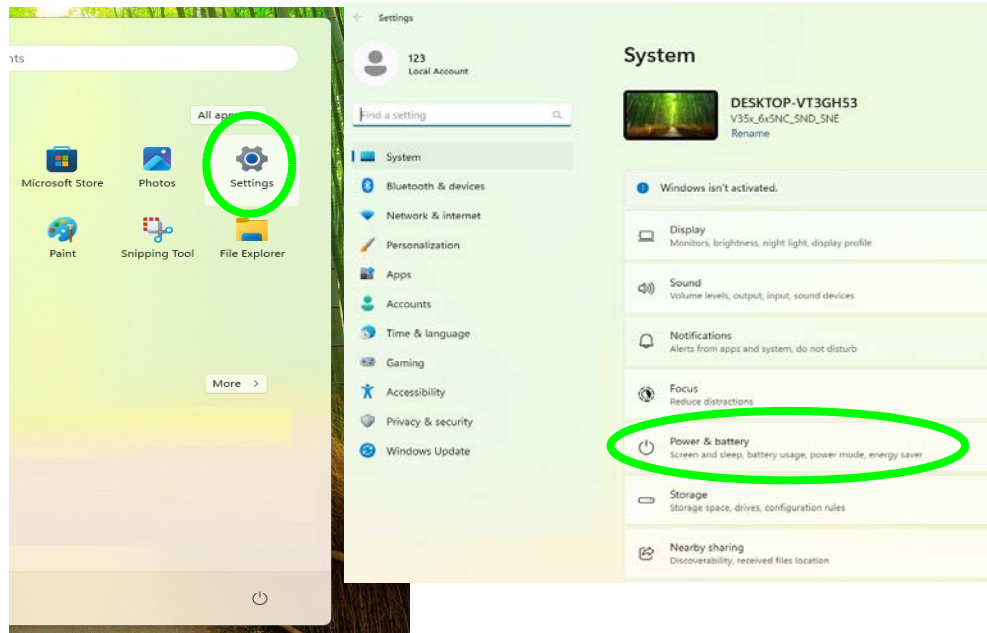

Figure 3 - 2
Settings > System
(Power & Battery)

The Power & battery control panel allows you to quickly adjust power options for **Power mode, Screen, sleep & hibernate timeouts, Energy saver, Battery usage and Lid, power & sleep button controls** etc.

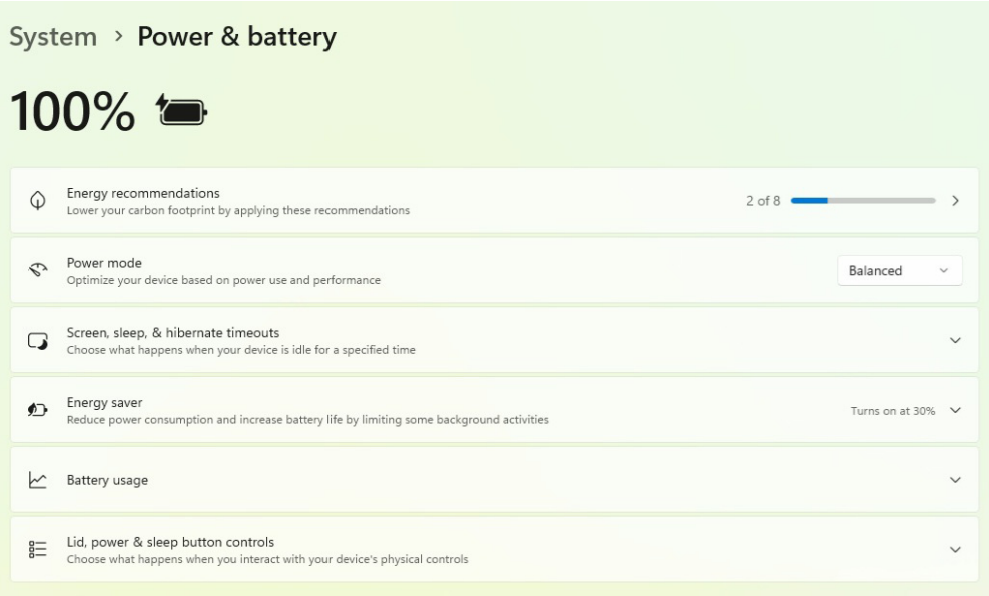

Figure 3 - 3
Power & Battery



Energy Saver

Note that some Windows features and background applications may behave differently, or may be blocked, when the system is in Energy saver mode (check with Microsoft for details).

Energy Saver & Battery Usage

Battery usage will display your battery levels and you can see the current state of battery usage by application. The **Energy saver** can be turned on when the system is battery powered, and can be set to run if the battery level falls below a certain percentage to limit background activity and push notifications.



Figure 3 - 4
Settings > Energy Saver & Battery Usage

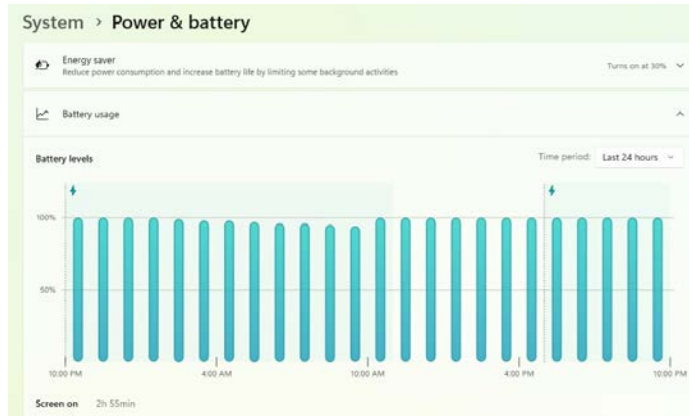

Screen, sleep & hibernate timeouts

Screen, Sleep and Hibernate settings can be adjusted for when the system is on battery power or is plugged in.

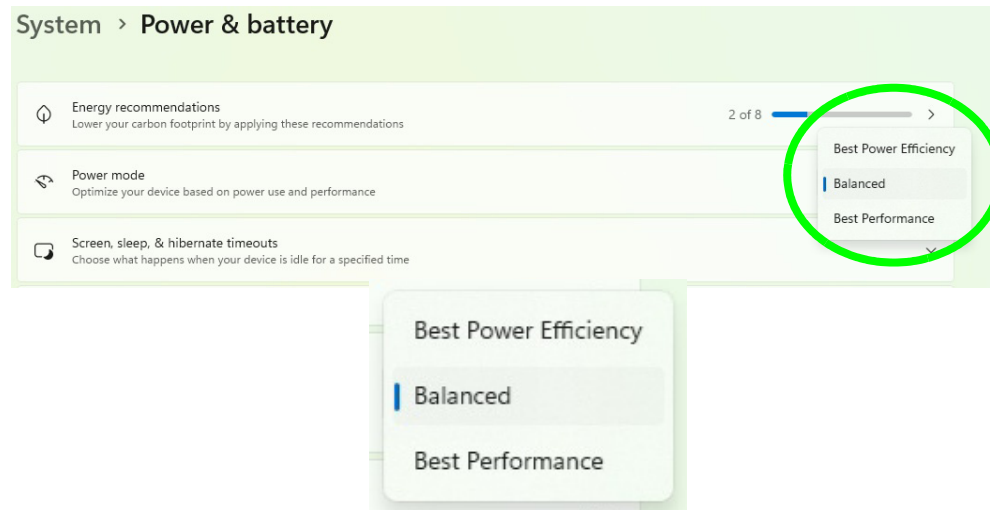

Figure 3 - 5
**Settings > Screen,
Sleep & Hibernate**

Power Mode

The **Power mode** can be set to **Balanced** (default) which balances performance and battery life, **Best power efficiency** for better battery life with reduced performance, and **Best Performance** for improved performance but with greater battery consumption.

Figure 3 - 6
Power Mode





Power Plans

The computer can be configured to conserve power by means of **power plans (Control Panel > Power Options)**. You can use (or modify) an existing **power plan**, or create a new one.

The settings may be adjusted to set the **display** to turn off after a specified time, and to send the computer into **Sleep** after a period of inactivity.

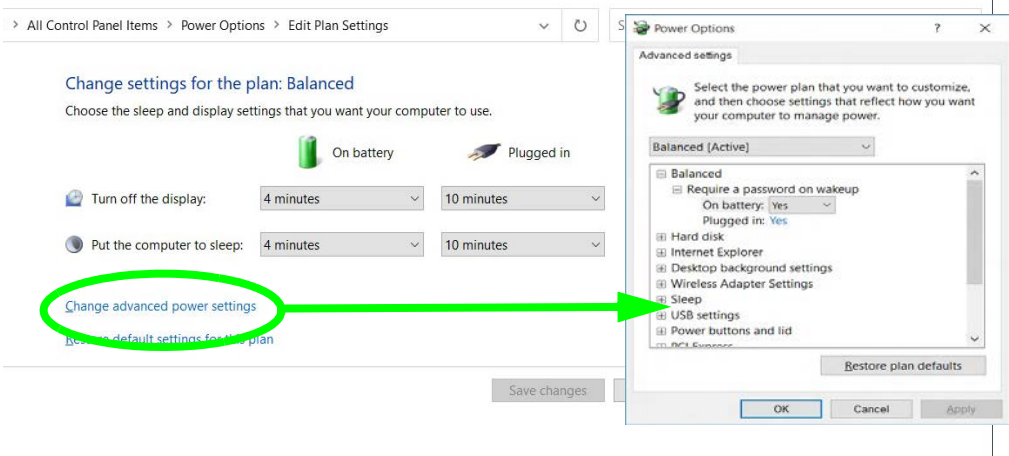
Click **Change plan settings** and then click **Change advanced power settings** to access further configuration options in **Advanced Settings**.





Resuming Operation

See *Table 3 - 1, on page 3 - 17* for information on how to resume from a power-saving state.

Password

It is recommended that you enable a password on system resume in order to protect your data.

Figure 3 - 7
Power Plan Advanced Settings

Power Management

3

Each **Windows power plan** will also adjust the processor performance of your machine in order to save power. This is worth bearing in mind if you are experiencing any reduced performance (especially under DC/battery power).

The Balanced power plan is the default, however you can click **Create a power plan** to create a customized power plan.

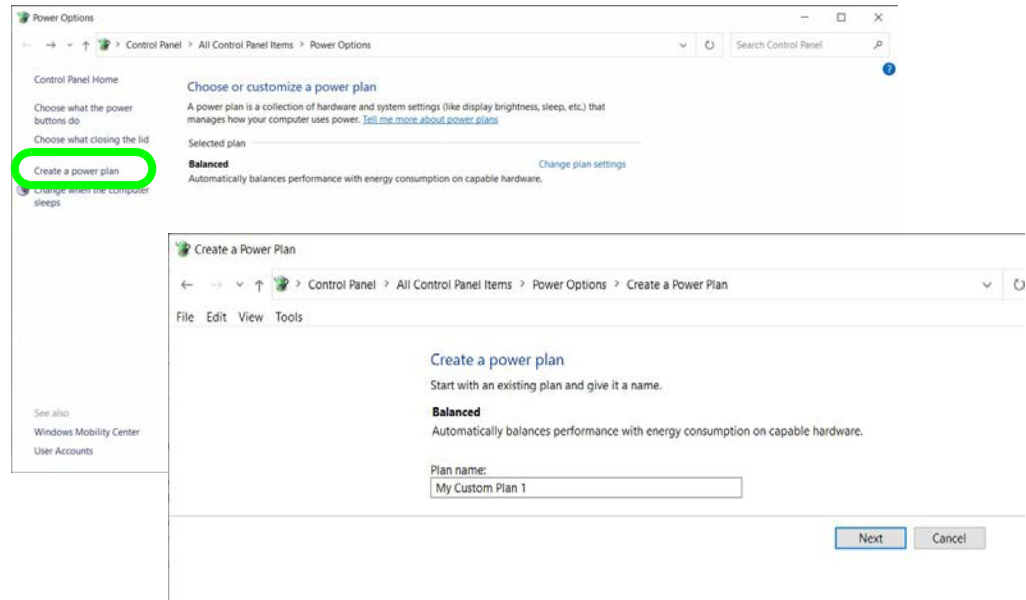

Figure 3 - 8
Power Plans

Power-Saving States

You can use power-saving states to stop the computer’s operation and restart where you left off. *Windows* uses the **Sleep**, **Hibernate** and **Shut Down** power-saving states.

Sleep

In **Sleep** all of your work, settings and preferences are saved to memory before the system sleeps. When you are not using your computer for a certain length of time, which you specify in the operating system, it will enter **Sleep** to save power.

The PC wakes from **Sleep within seconds** and will return you to where you last left off (what was on your desktop) without reopening the application(s) and file(s) you last used.

If your mobile PC in **Sleep** is running on battery power the system will use only a minimum amount of power. After an extended period the system will save all the information to the hard disk and shut the computer down before the battery becomes depleted.

To add **Sleep** to the **Power Menu** see *“Adding Hibernate/Sleep (Modern Standby) to the Power Menu” on page 3 - 16.*



Wake On LAN Support



Wake-On-LAN is only supported from **Sleep** or **Hibernate** states in *Windows*.

If you require your computer to wake up from network activity in *Windows* then make sure that the computer is either in **Sleep** or **Hibernate**.

Wake-On-LAN is not supported from **Shut-down** states in *Windows*.



Right-Click Start Menu Power

You can also use the context menu (right-click the Start Menu  icon or press the Windows logo  + X key combination) to Sign out, Sleep, Hibernate, Shut down, and Restart.

Hibernate

Hibernate uses the least amount of power of all the power-saving states and saves all of your information on a part of the hard disk before it turns the system off. If a power failure occurs the system can restore your work from the hard disk; if a power failure occurs when work is saved only to memory, then the work will be lost. **Hibernate** will also return you to where you last left off within seconds. You should put your mobile PC into **Hibernate** if you will not use the computer for a period of time, and will not have the chance to charge the battery. To add **Hibernate** to the **Power Menu** see *“Adding Hibernate/Sleep (Modern Standby) to the Power Menu” on page 3 - 16.*

Shut down

You should **Shut down** the computer if you plan to install new hardware, plan to be away from the computer for several days, or you do not need it to wake up and run a scheduled task. Returning to full operation from **Shut down** takes longer than from **Sleep** or **Hibernate**.

Figure 3 - 9
Power Button & Start Menu (Power) Shut Down or Sign Out

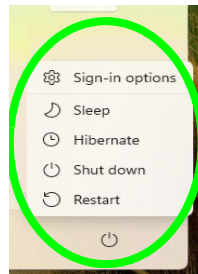

Using the Power Button

1. Go to the **Start Menu**.
2. Click the **Power button** .
3. Select the power state required from the menu

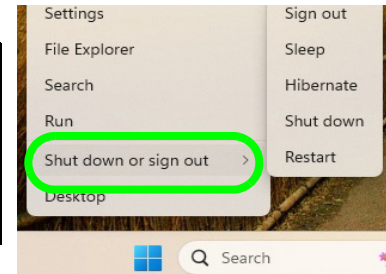

Configuring the Power Buttons

The power/sleep button (Fn + F12 key combo) and closed lid may be set to send the computer in to a power-saving state. Click **Choose what the power buttons do** on the left menu in **Power Options** to bring up the menu.

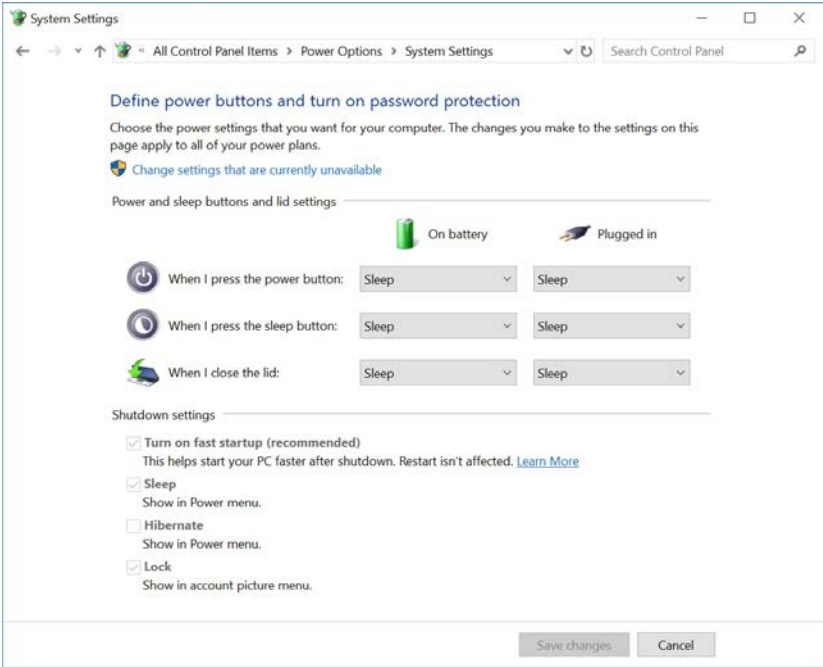

Pen icon

Password Protection

It is recommended that you enable a password on wake up in order to protect your data.

However you can disable this setting from the **Power Options** menu by clicking **Require a password on wakeup** in the left menu, and selecting the options (click **Change settings that are currently unavailable**).

Figure 3 - 10
Power Options
Define Power Buttons

Adding Hibernate/Sleep (Modern Standby) to the Power Menu

Add **Hibernate/Sleep** to the **Power Menu** as follows.

1. Go to the **Power Options (Hardware and Sound)** control panel.
2. Click "**Change settings that are currently unavailable**"  [Change settings that are currently unavailable](#).
3. Click **Choose what the power buttons do**.
4. Click to put a check in the **Hibernate/Sleep** box under **Shutdown settings**.
5. Click **Save Changes** and close the control panel.

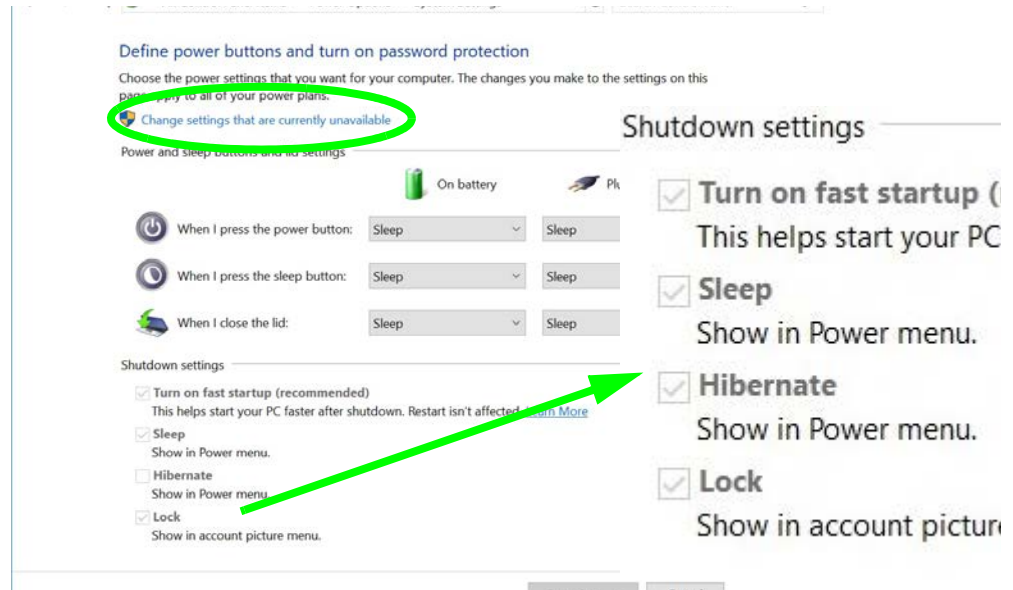

Figure 3 - 11
Power Options
Define Power
Buttons - Shutdown
Settings

Resuming Operation

You can resume operation from power-saving states by pressing any keyboard key (if the system is in **Sleep**), the power button, or in some cases pressing the sleep button (**Fn + F12** key combo).



Power Status	Icon  Color	To Resume
Power Off	Off	Press the Power Button
Sleep (Modern Standby)	Blinking Green	Press the Power Button Press the Sleep Button (Fn + F12 Key Combo)
Hibernate	Off (battery) Orange (AC/DC adapter)	Press the Power Button
Display Turned Off	Green	Press a Key or Move the Mouse/Touchpad

Table 3 - 1 Resuming Operation



Power Button

When the computer is on, you can use the power button as a Sleep/Hibernate/Shut Down hot key button when it is pressed for less than **4 seconds** (pressing and holding the power button for longer than this will force the computer to shut down).



Closing the Lid

If you have chosen to send the computer to **Sleep (Modern Standby)** when the lid is closed, raising the lid will wake the system up.

Ctrl + Alt + Delete Key Combination

You can use the **CTRL + ALT + DEL** key combination from almost any of the *Windows* interfaces/Apps to bring up a full-screen displaying **Lock**, **Switch User**, **Sign out**, **Change a password** and **Task Manager** options. If you click the **Power** icon in the lower right corner of the screen a power management option menu appears to display **Sleep** (Modern Standby), **Shut down**, and **Restart**.

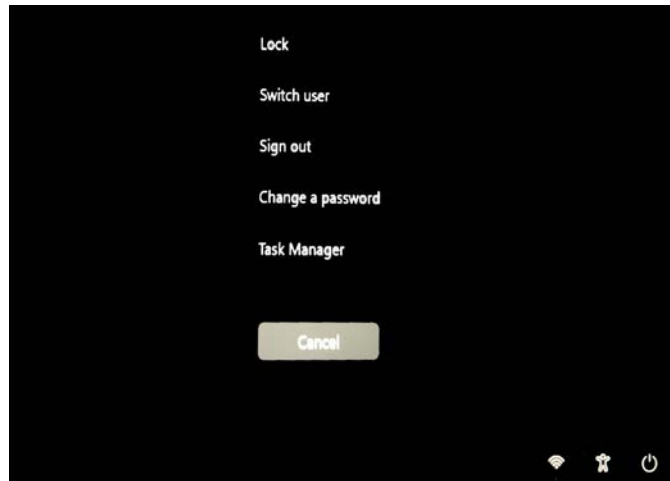

Figure 3 - 12
Ctrl + Alt + Delete
Menu

To fully control all the power options (including Hibernate mode) go to the **Power Options** control panel and configure the power button, sleep button and lid to perform the function selected.

Battery Information

Follow these simple guidelines to get the best use out of your battery.

Battery Power

Your computer’s battery power is dependent upon many factors, including the programs you are running, and peripheral devices attached. You can set actions to be taken (e.g. Shut down, Hibernate etc.), and set critical and low battery levels from power plan **Change plan settings > Change advanced power settings**.

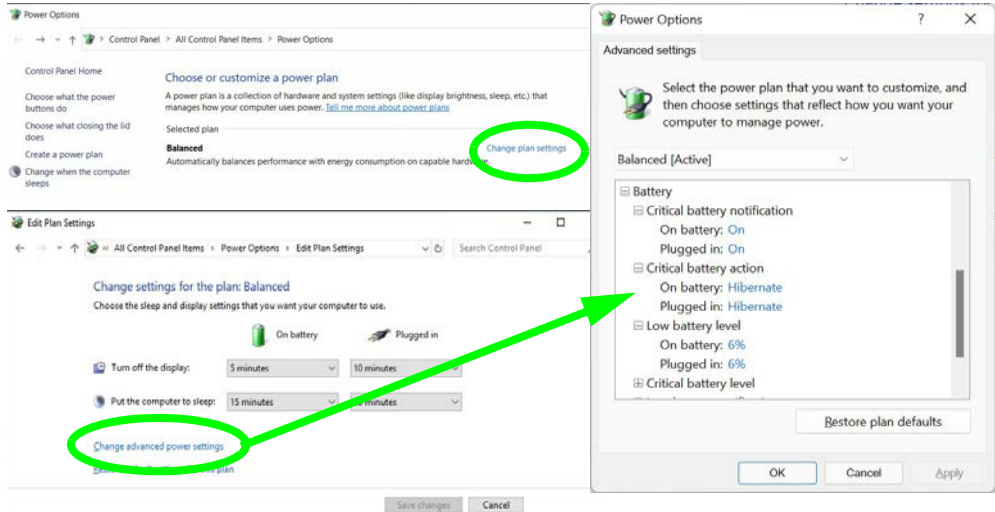



**Low Battery
Warning**

When the battery is critically low, immediately connect the AC/DC adapter to the computer or save your work, otherwise, the unsaved data will be lost when the power is depleted.

Figure 3 - 13
Power Options
(Battery)

Power Management

Click the battery icon  in the **Action Center** to access the Power & battery control panel (see page 3 - 7) and you can view the battery level.

3

Figure 3 - 14
Action Center

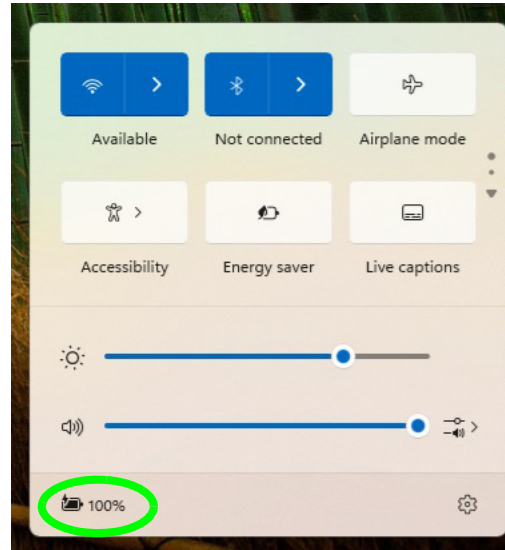

See also *“Energy Saver & Battery Usage”* on page 3 - 8 (which can be turned on when the system is battery powered), and you can click on **Battery usage** to view detailed battery information.

Conserving Battery Power

- Use a **power plan** that conserves power (e.g **Power saver**), however note that this may have an affect on computer performance.
- Lower the brightness level of the LCD display. The system will decrease LCD brightness slightly to save power when it is not powered by the AC/DC adapter.
- Reduce the amount of time before the display is turned off.
- Close wireless, Bluetooth, modem or communication applications when they are not being used.
- Disconnect/remove any unnecessary external devices e.g. USB devices, ExpressCards etc.

Windows Mobility Center

The **Windows Mobility Center** control panel provides an easy point of access for information on battery status, power plans used and wireless device status etc.

3

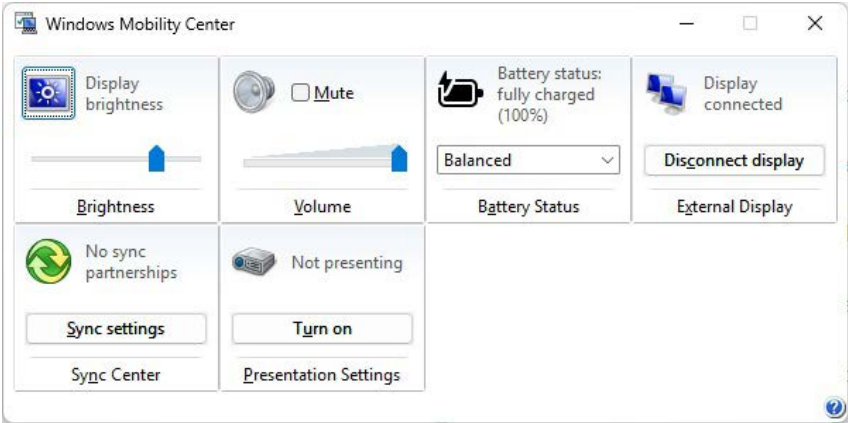

Figure 3 - 15
Windows Mobility Center (Control Panel)

Battery Life

Battery life may be shortened through improper maintenance. **To optimize the life and improve its performance, fully discharge and recharge the battery at least once every 30 days.** We recommend that you do not remove the battery yourself as the removal of the bottom cover may violate the terms of your warranty.

Charging The Battery Under Heavy Use

If the computer is being used under a heavy system load (e.g. games or other high-end graphic apps) in battery mode, **try to avoid a cycle of repeatedly plugging and unplugging the adapter to charge the battery.**

Repeatedly plugging and unplugging the adapter may cause inaccuracies in the battery mechanics when displaying battery life and charge, and this may result in a system shutdown despite the battery meter displaying a sufficient remaining charge.

Ideally, if the computer is being used under a heavy system load you should try to use the AC/DC adapter, but if using the battery avoid plugging and unplugging the adapter and allow the battery to fully charge again before switching to battery mode.

New Battery

Always completely discharge, then fully charge, a new battery (see *[“Battery FAQ”](#)* on page 3 - 24 for instructions on how to do this).

Recharging the Battery with the AC/DC Adapter

The battery pack automatically recharges when the AC/DC adapter is attached and plugged into an electrical outlet. If the computer is powered on, and in use, it will take several hours to fully recharge the battery. When the computer is turned off but plugged into an electrical outlet, battery charge time is less. Refer to *“LED Indicators” on page 1 - 9* for information on the battery charge status, and to *“Battery FAQ” on page 3 - 24* for more information on how to maintain and properly recharge the battery pack.

Proper handling of the Battery Pack

- DO NOT disassemble the battery pack under any circumstances
- DO NOT expose the battery to fire or high temperatures, it may explode
- DO NOT connect the metal terminals (+, -) to each other



Damaged Battery Warning

Should you notice any physical defects (e.g. the battery is bent out of shape after being dropped), or any unusual smells emanating from the notebook battery, shut your computer down immediately and contact your distributor/supplier. If the battery has been dropped we do not recommend using it any further, as even if the computer continues to work with a damaged battery in place, it may cause circuit damage, which may possibly result in fire. It is recommended that you replace your computer battery every two years.



Caution

Danger of explosion if battery is incorrectly re-placed.

Replace only with the same or equivalent type recommended by the manufacturer. Discard used battery according to the manufacturer's instructions.

Battery FAQ

How do I completely discharge the battery?

Use the computer with battery power until it shuts down due to a low battery. Don't turn off the computer even if a message indicates the battery is critically low, just let the computer use up all of the battery power and shut down on its own.

1. Save and close all files and applications.
2. **Create a power plan** for discharging the battery and set all the options to **Never**.
3. Click **Change plan settings** (after creating it) and click **Change plan settings > Change advanced power settings**.

Figure 3 - 16
Change Plan
Settings / Change
Advanced Power
Settings

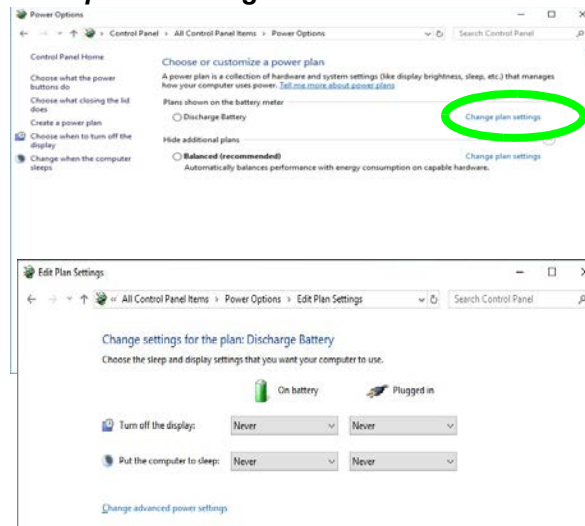

- 4. Scroll down to **Battery** and click **+** to expand the battery options.
- 5. Choose the options below (click **Yes** if a warning appears):

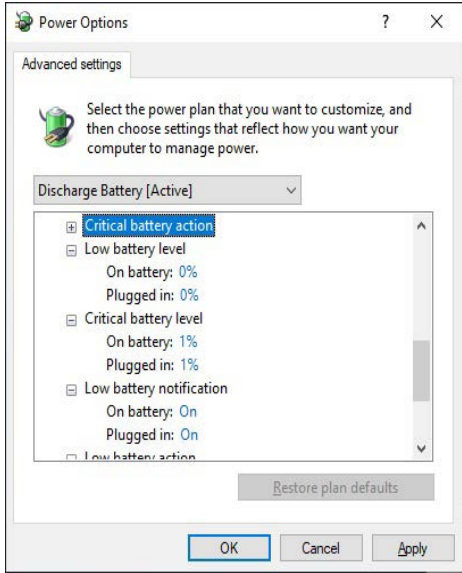

Figure 3 - 17
Power Options
Advanced Settings -
Battery

- Low battery level = 0%
- Critical battery level = 1%
- Low battery action = Do Nothing
- Reserve Battery Level = 0%

How do I fully charge the battery?

When charging the battery, don't stop until the LED charging indicator light changes from orange to green.

How do I maintain the battery?

Completely discharge and charge the battery at least once every 30 days or after about 20 partial discharges.

Chapter 4: Drivers & Utilities

This chapter deals with installing the drivers and utilities essential to the operation or improvement of some of the computer's subsystems. The system takes advantage of some newer hardware components for which the latest versions of most available operating systems haven't built in drivers and utilities. Thus, some of the system components won't be auto-configured with an appropriate driver or utility during operating system installation. Instead, you need to manually install some system-required drivers and utilities.

What to Install

You will need to attach an external optical CD/DVD device drive to install the drivers from the *Device Drivers & Utilities + User's Manual* disc. The disc contains the drivers and utilities necessary for the proper operation of the computer. *Table 4 - 1, on page 4 - 4* lists what you need to install and **it is very important that the drivers are installed by the method outlined in this chapter, and in the order indicated.**

Module Driver Installation

The procedures for installing drivers for the **Wireless LAN** and **Combination Bluetooth & WLAN** modules are provided in *"Drivers & Utilities" on page 4 - 1*.



Driver Installation & Power

When installing drivers make sure your computer is powered by the AC/DC adapter connected to a working power source. Some drivers draw a significant amount of power during the installation procedure, and if the remaining battery capacity is not adequate this may cause the system to shut down and cause system problems (note that there is no safety issue involved here, and the battery will be rechargeable within 1 minute).

Driver Installation

1. Insert the *Device Drivers & Utilities + User's Manual* disc into an attached DVD drive.
2. Click the message “**Tap to choose what happens with this disc.**”
3. Click **Run autorun.exe**.
4. Click **Install Drivers** (button), or **Option Drivers** (button) to access the **Optional** driver menu.



Figure 4 - 1 - Drivers Installer Screen 1

- 5. Check the driver installation order from **Table 4 - 1, on page 4 - 4** (the drivers must be installed in this order) which is the same as that listed in the *Drivers Installer* menu below.
- 6. Click to select the driver you wish to install, (you should note down the drivers as you install them).
- 7. Follow the instructions for each individual driver installation procedure as listed on the following pages.



Figure 4 - 2 - Install Drivers

Drivers & Utilities

4

Win 11 Drivers System Required	Page #	Win 11 Drivers Other / Options	Page #
<i>Chipset</i>	<i>Page 4 - 7</i>	<i>RAID Mode Setup</i>	<i>Page 6 - 2</i>
<i>Serial IO</i>	<i>Page 4 - 7</i>	<i>Wireless LAN Module</i>	<i>Page 6 - 11</i>
<i>VGA Driver</i>	<i>Page 4 - 7</i>	<i>Bluetooth Module</i>	<i>Page 6 - 20</i>
<i>NVIDIA Video (VGA)</i>	<i>Page 4 - 8</i>	<i>Intel® Speed Shift Technology Driver</i>	<i>Page 6 - 26</i>
<i>NVIDIA App</i>	<i>Page 4 - 8</i>	<i>Intel® GNA Driver</i>	<i>Page 6 - 32</i>
<i>Control Center</i>	<i>Page 4 - 8</i>	<i>X-Rite Color Assistant</i>	<i>Page 6 - 27</i>
<i>LAN</i>	<i>Page 4 - 8</i>	<i>Intel® Neural Processing Unit Driver</i>	<i>Page 6 - 33</i>
<i>CardReader</i>	<i>Page 4 - 9</i>	<i>Webcam Module</i>	<i>Page 6 - 35</i>
<i>Intel® HID Filter Driver</i>	<i>Page 4 - 9</i>	<i>IR (Hello) Camera</i>	<i>Page 6 - 42</i>
<i>MEI Driver</i>	<i>Page 4 - 9</i>	<i>Creative Sound Blaster Studio Pro 2 Audio</i>	<i>Page 6 - 51</i>
<i>Intel® Dynamic Tuning Technology Driver</i>	<i>Page 4 - 9</i>	<i>Trusted Platform Module (No driver required)</i>	<i>Page 6 - 67</i>
<i>Creative Sound Blaster Studio Pro 2 Audio</i>	<i>Page 4 - 10</i>	<p><i>All drivers provided are for Windows 11.</i></p> <p><i>Note that you need to install both the WLAN & Bluetooth drivers for the WLAN & Bluetooth Combo modules.</i></p>	
<i>Audio</i>	<i>Page 4 - 10</i>		
<i>Creative Sound Blaster Studio Pro 2 Audio App</i>	<i>Page 4 - 11</i>		

Table 4 - 1 - Driver Installation

Manual Driver Installation

Click **Browse CD/DVD** (button) in the *Drivers Installer* application and browse to the executable file in the appropriate driver folder.



Windows Update

After installing all the drivers, make sure you enable Windows Update to get the latest security updates, etc. (all updates will include the latest hotfixes from Microsoft).

To enable **Windows Update** make sure you are connected to the internet:

1. Go to **Settings in Windows**.
2. Click **Windows Update** (Update & Security).
3. Click **Check for updates** (button).
4. The computer will now check for updates (you need to be connected to the internet).
5. Click **Install now** (button) to begin checking for the updates.
6. Click **Install updates** (button) to install the updates.

Updating/Reinstalling Individual Drivers

If you wish to update/reinstall individual drivers it may be necessary to uninstall the original driver. To do this go to the **Control Panel** in the *Windows OS* and double-click the **Programs** icon (**Programs > Uninstall a program**). Click to select the driver (if it is not listed see below) and click **Uninstall**, and then follow the on screen prompts (it may be necessary to restart the computer). Reinstall the driver as outlined in this chapter.

If the driver is not listed in the **Programs and Features** menu:

1. Go to the **Control Panel**.
2. Double-click **Device Manager (Hardware and Sound > Devices and Printers > Device Manager)**.
3. Double-click the **device** you wish to update/reinstall the driver for (you may need to click “+” to expand the selection).
4. Click **Driver** (tab) and click the **Update Driver** or **Uninstall** button and follow the on screen prompts.

User Account Control

If a **User Account Control** prompt appears as part of the driver installation procedure, click **Continue** or **Allow**, and follow the installation procedure as directed.

Windows Security Message

If you receive a *Windows* security message as part of the driver installation process. Just click **“Install this driver software anyway”** or **“Install”** to continue the installation procedure.

You will receive this message in cases where the driver has been released after the version of *Windows* you are currently using. All the drivers provided will have already received certification for *Windows*.

New Hardware Found

If you see the message **“New Hardware Found”** during the installation procedure (**other than when outlined in the driver install procedure**), click **Cancel** to close the window, and follow the installation procedure.



Driver Installation General Guidelines

The driver installation procedure outlined in this Chapter (and in **Chapter 7 Options & Modules**), are accurate at the time of going to press.

Drivers are always subject to upgrade and revision so the exact procedure for certain drivers may differ slightly. As a general guide follow the default on screen instructions for each driver (e.g. **Next > Next > Finish**) unless you are an advanced user. In many cases a restart is required to install the driver.

Make sure any modules (e.g. WLAN or Bluetooth) are **ON (i.e. the system is not in Airplane Mode)** before installing the appropriate driver.

Driver Installation Procedure

Insert the *Device Drivers & Utilities + User's Manual disc* and click **Install Drivers** (button).

Chipset

1. Click **1.Install Chipset Driver > Yes**.
2. Click **Next > Accept > Install**.
3. Click **Finish**.

Serial IO

1. Click **2.Install Serial I/O Driver > Yes**.
2. Click **Next**.
3. Click the button to accept the license agreement and click **Next**.
4. Click **Next > Next**.
5. Click **Finish**.

VGA Driver

1. Click **3.Install VGA Driver > Yes**.
2. Click **Begin Installation**.
3. Scroll down to agree to the terms and conditions and click **I agree**.

4. Click **Start**.
5. Click **Reboot Required** to restart the computer.
6. **Intel Graphics Command Center** will download but you will need to have a working internet connection.
7. Click the **Start** menu in Windows to access the **Microsoft Store App** tile.
8. Click the **Sign in** icon  and select **Library**.
9. Click **Get Updates**.
10. A list of apps being downloaded will pop-up.
11. When finished the **Intel Graphics Command Center** will appear in the **Windows Start** menu.

Note: After installing the video driver go to the **Display/Display Settings** control panel to adjust the video settings to the highest resolution.

NVIDIA Video (VGA)

1. Click **4.Install NVIDIA VGA Driver > Yes**.
2. Click **Agree and Continue** (button) to accept the terms of the license agreement.
3. Click **Next**.
4. Click **Restart Now** to restart the computer.
5. Go to the Microsoft Store to download the NVIDIA Control Panel.

Note: After installing the video driver go to the **Display** control panel to adjust the video settings to the highest resolution.

NVIDIA App

1. Click **5.Install NVIDIA Apps > Yes**.
2. Click **Agree and Continue** (button) to accept the terms of the license agreement.
3. Click **Next**.
4. Click **Close** to complete the installation.
5. After all the drivers have been installed (an internet connection is required) run the **NVIDIA App** by clicking the desktop icon  (or App).

Control Center

1. Click **6.Install Ctrl Center Driver > Yes**.
2. Click **Next > Install**.
3. Click **Finish > Finish** to restart the computer.

LAN

*Note: If the computer enters a deep sleep mode during installation, you will be prompted to plug in a network cable, and click **OK**, to continue installation. If a network cable is not available, restart the system and re-install the LAN driver.*

1. Click **7.Install LAN Driver > Yes**.
2. The **OK** prompt will pop-up several times, so keep clicking it until the prompt stops appearing to complete the installation of the driver.
3. A Command Prompt window will pop-up as the driver installs.
4. **You can then download the Killer Intelligence Center** app from the Microsoft Store but you will need to have a working internet connection.

5. After the driver is installed an automatic browser window will pop-up and you can click the “**Get**” button to start the installation.
6. Alternatively click the **Start** menu in Windows to access the **Microsoft Store** app tile.
7. You can then search by typing “**Killer Intelligence Center**” in the search window (click the magnifying glass icon in the top right corner of the screen) and click to install the app.
8. When installed the **Killer Intelligence Center** will appear in the **Windows Start** menu.

CardReader

1. Click **8.Install Cardreader Driver > Yes.**
2. Click **Next > Next > Next.**
3. Click **Close** to complete the installation.

Intel® HID Filter Driver

1. Click **9.Install HID Filter Driver > Yes.**
2. Click **OK > OK** to complete the installation.

MEI Driver

1. Click **10.Install MEI Driver > Yes.**
2. Click **Next.**
3. Click the check box to accept the license and then click **Next.**
4. Click **Next.**
5. Click **Finish.**

Intel® Dynamic Tuning Technology Driver

1. Click **11.Install DTT Driver > Yes.**
2. Click **OK** (the prompt will pop-up several times so keep clicking it until it disappears) to complete the installation.

Creative Sound Blaster Studio Pro 2 Audio

1. Click **12.Install Creative Driver > Yes**.
2. Select the installation language and click **OK**.
3. Click to accept the terms of the license agreement and then click **Next**.
4. Click **Next > Install**.
5. Click **Finish**.
6. Click **OK** and the system will automatically restart to complete the driver installation process.
7. The **Creative App** will download but you will need to have a working internet connection.
8. Click the **Start** menu in Windows to access the **Microsoft Store App** tile.
9. Click the **Sign in** icon  and select **Library**.
10. Click **Get Updates**.
11. A list of apps being downloaded will pop-up.
12. When installed the **Creative App** will appear in the **Windows Start** menu.

Audio

1. Click **13.Install Audio Driver > Yes**.
2. Click **Next**.
3. Click **Finish** to restart the computer.
4. **Realtek Audio Control Panel** will download but you will need to have a working internet connection.
5. Click the **Start** menu in Windows to access the **Microsoft Store App** tile.
6. Click the **Sign in** icon  and select **Library**.
7. Click **Get Updates**.
8. A list of apps being downloaded will pop-up.
9. When installed the **Realtek Audio Console** will appear in the **Windows Start** menu.

Creative Sound Blaster Studio Pro 2 Audio App

1. Click **Browse CD/DVD** (button) from *Device Drivers & Utilities + User's Manual disc* and navigate to *Options//PreInstallKit/04_Creative* and double-click **SBStudioProInstallerSetup_XXXXX**.
2. Click **Install > Finish**.
3. Then click **Browse CD/DVD** (button) from *Device Drivers & Utilities + User's Manual disc* and navigate to *Options//PreInstallKit/04_Creative* and double-click **CreativeAppSetup_XXXXX**.
4. Select the installation language and click **OK**.
5. Click to accept the terms of the license agreement and then click **Next**.
6. Click **Next > Next > Install**.
7. Click **Finish** to restart the computer to complete the installation.

After installing the audio driver the system will not return to the **Drivers Installer** screen. To install any of the optional drivers, eject the *Device Drivers & Utilities + User's Manual disc* and then reinsert it (or double-click the disc icon in My Computer), and click **Option Drivers** (button) to access the optional driver menu.

Optional Drivers

See the pages indicated in *Table 4 - 1, on page 4 - 4* for the driver installation procedures for any modules included in your purchase option.



Figure 4 - 3 - Optional Drivers Installer Screen

Note that you need to install both the WLAN & Bluetooth drivers for the WLAN & Bluetooth Combo modules.

Chapter 5: BIOS Utilities

Overview

This chapter gives a brief introduction to the computer's built-in software **BIOS** (Basic Input/Output System).

If your computer has never been set up, or you are making important changes to the system (e.g. hard disk setup), then you should review this chapter first and note the original settings found in **BIOS**. Even if you are a beginner, keep a record of the settings you find and any changes you make. This information could be useful if your system ever needs servicing.

There is one general rule: *Don't make any changes unless you are sure of what you are doing*. Many of the settings are required by the system, and changing them could cause it to become unstable or worse. If you have any doubts, consult your service representative.

To enter *BIOS*, turn on the computer and press F2 as the system “Boots up”.



BIOS Screens

Note that the BIOS screens pictured on these pages are intended for guidance in setting up your system's BIOS.

BIOS versions are subject to constant change and revision, therefore your computer's actual screens may appear slightly different from those pictured on these pages.



BIOS Settings Warning

Incorrect settings can cause your system to malfunction. To correct mistakes, return to *BIOS* and **Load Optimized Defaults** (press F9).



BIOS Menus

The menus shown in this section are for **reference** only. Your computer's menus will indicate the configuration appropriate for your model and options.

The Insyde BIOS Utility

Each time you turn on the computer the system takes a few seconds to conduct a including a quick test of the on-board RAM (memory).

As the boot process proceeds, the computer will tell you if there is anything wrong. If there is a problem that prevents the system from booting, it will display a system summary and prompt you to run the BIOS setup.

If there are no problems the system will load the operating system. Once that starts, you can't get into **BIOS** without rebooting.

The **Setup BIOS Utility** tells the system how to configure itself by translating instructions from the operating system, and other software, into instructions that the computer hardware understands. manage basic features, identify installed devices and subsystems (e.g. port configuration).



BIOS and Resuming From Hibernation

When the system **resumes from Hibernation** the option will be available to press F2 to enter the BIOS. **In this case do not make any changes to the BIOS settings** as this may result in system errors.

If you wish to change the BIOS settings, restart the system and press F2 to enter the BIOS to make and save any changes required.

Updating the BIOS / CPU

If you need to update the BIOS please contact your distributor or supplier to obtain the latest version.

After using the utility to update the BIOS (or if the CPU has been changed) you will need to **press F2 at Boot** to enter the BIOS, and then **press F9 to load the BIOS defaults**, and then **press F10 to save and exit** the settings.

After the system restarts you should press **F2** to enter the BIOS again and reset the BIOS settings to your preferences, and then save the final settings.

UEFI Boot

UEFI (Unified Extensible Firmware Interface) is an advanced firmware standard supporting fast startup.

With UEFI Boot prompts at boot to press **F2** (to access the BIOS) or **F7** (to access Boot options) will not appear. However you can still press **F2** to enter the setup, or **F7** to choose the preferred boot device, if you press the key immediately the system boots up.

To enter *BIOS*, turn on the computer and press F2 as the system “Boots up”.

If the computer is already on, reboot using the **Ctrl + Alt + Delete** combination and then hold down **F2** when prompted. The *BIOS* main menu will appear. To see the boot options press **F7** and choose your preferred boot device.

Insyde BIOS Start Screen

On accessing the BIOS you will be presented with the Start Screen with 5 menu icons, date and time information, CPU temperature information and navigation and Help icons at the bottom of the screen.

You can use the Touchpad, an attached mouse, or the cursor/arrow keys to navigate the menus and press *Enter* to access the submenu.



Figure 5 - 1
Insyde BIOS Start Screen

Insyde BIOS Start Screen Options:

- **Continue:** Press *Enter* here or click *Continue* to carry on with the boot process and load the operating system.
- **Boot Manager:** Press *Enter* here or click *Boot Manager* to access the Boot Manager utility.
- **Boot From File:** Press *Enter* here or click *Boot From File* to select a file or device to Boot from.
- **Administer Secure Boot:** Press *Enter* here or click *Administer Secure Boot* to proceed with a Secure Boot process. This will take you to the Secure Boot screen which allows you to manage secure boot settings.
- **Setup Utility:** Press *Enter* here or click *Setup Utility* to access the BIOS settings in the Setup Utility.

Note to return to the Start Screen from any of the submenus press the *Esc* key.

Boot Manager

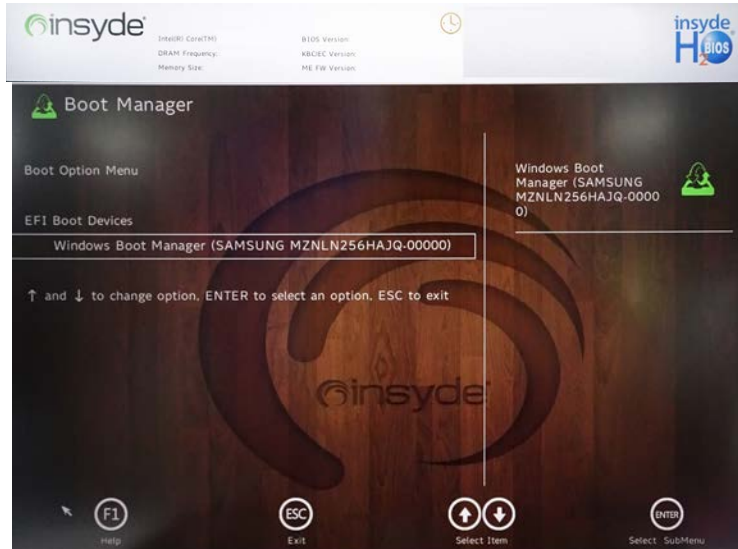

Figure 5 - 2
Boot Manager

When you turn the computer on it will look for an operating system from the devices listed in this menu, and **in this priority order**. If it cannot find the operating system on that device, it will try to load it from the next device in the order specified in the **Boot Option Menu**.

Press Enter to access the menu, use the arrow keys to move up and down the menu, and press Enter to select a device.



BIOS Screens

Note that the BIOS screens pictured on these pages are intended for guidance in setting up your system's BIOS.

BIOS versions are subject to constant change and revision, therefore your computer's actual screens may appear slightly different from those pictured on these pages.

Boot From File / File Explorer

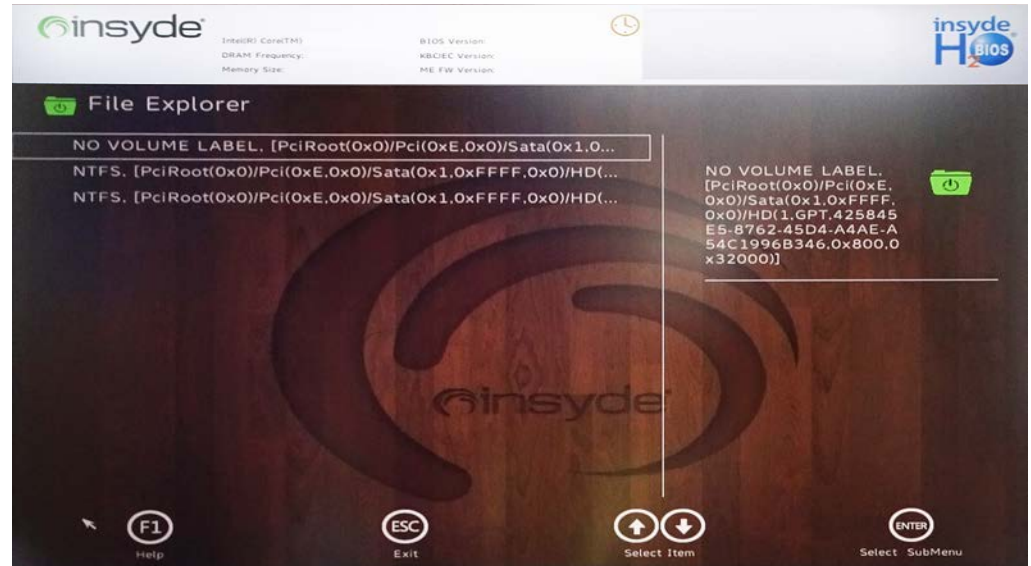

Figure 5 - 3
Boot From File
(File Explorer)

If you need to boot from a file (e.g. on a USB flash drive) then access this menu and use the cursor keys to select the device or file (you can press *Enter* to explore for a file on an attached device).

Administer Secure Boot

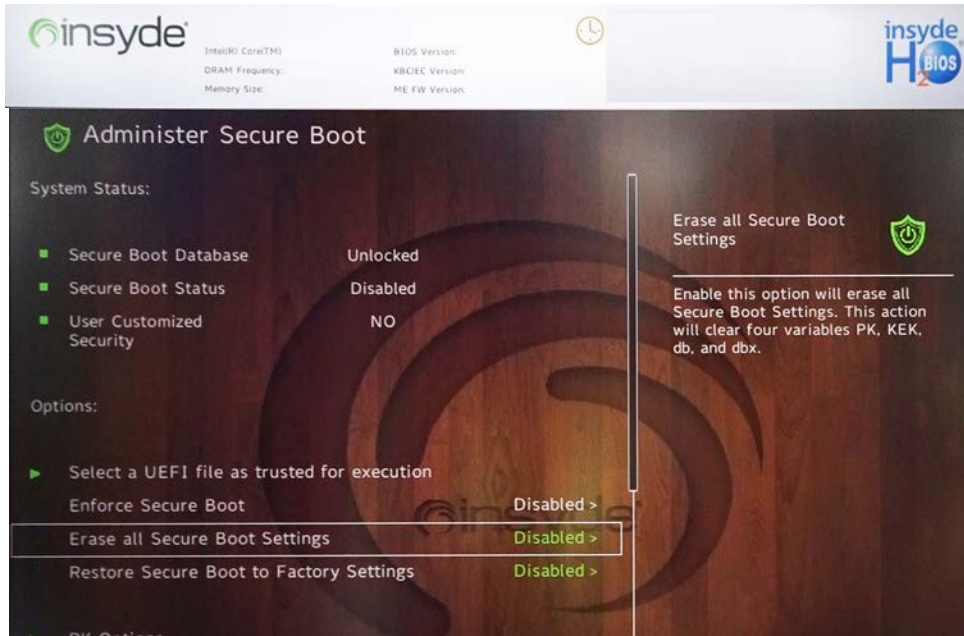

Figure 5 - 4
Administer Secure Boot

Secure Boot prevents unauthorized operating systems and software from loading during the startup process. You can select a trusted UEFI file to execute the BIOS, make sure that you Enforce Secure Boot, Erase all Secure Boot Settings or Restore the Factory Settings.

You can also make custom changes to the Key Management database if required by accessing the advanced secure boot options for Platform Key (PK Options), Key Exchange Key (KEK Options), Allowed Signatures Database (DB Options) and Forbidden Signatures Database (DBX Options).



Figure 5 - 5
Administer Secure Boot (Advanced Secure Boot Options)

Setup Utility - Main Menu



Figure 5 - 6
Main (Upper)

System Time & System Date (Main Menu)

The hour setting uses the 24-hour system (i.e., 00 = midnight; 13 = 1 pm). If you can change the date and time settings in your operating system, you will also change these settings. Some applications may also alter data files to reflect these changes.

System/Extended Memory: (Main Menu)

This item contains information on the system memory, and is not user configurable. The system will auto detect the amount of memory installed.

ME FW Version / MB Series / BIOS Version / KBC/EC firmware Version / MAC Address

This item contains information on the BIOS version and is not user configurable.

Your system's CPU will be listed in the Main menu e.g. *Intel(R) Core(TM)....*

Setup Utility - Advanced Menu



5

Figure 5 - 7
Advanced Menu

Advanced Chipset Control (Advanced Menu)

The sub-menu here allows you to set the **Display Mode**, enable/disable the **Flexicharger**, **VT-d**, **UEFI OS Fast Boot**, **Battery Saver** and **USB Power Delivery Compatibility**.

Overclocking Performance Menu (Advanced Menu)

(For Some Processors Only)

This menu will be *available for processors that support CPU overclocking*. Click on **Overclocking Performance Menu** and then click on the **Overclocking Feature** item to enable it (it is **Disabled by default**) and to configure the **Memory** settings from the **Control Center**.

Intel Rapid Storage Technology

When the VMD controller is enabled this menu item will become available. Intel Rapid Storage Technology allows you to set up a RAID system if you have the appropriate hardware (two Identical solid state drives) installed in your system (see *“RAID Mode Setup” on page 6 - 2*).

Enable VMD Controller (Advanced Menu)

Intel VMD (Volume Management Device) is a storage controller with hardware logic inside the CPU, and this helps manage NVMe SSDs. With VMD mode enabled the **Intel Rapid Storage Technology** item will be accessible and this will allow you to setup a RAID system.

The **VMD Mode** should be set **BEFORE installing an operating system**, and after you have backed up all necessary files and data (see sidebar). See **“RAID Mode Setup” on page 6 - 2** for details. Make sure you install the **IRST driver for a RAID system**.

If you wish to change your VMD mode to/from Enabled/Disabled note that doing so may prevent your operating system from booting, and may require a reinstall of the OS. If you do wish to change the VMD mode then backup any necessary data on your hard disk(s) as you will need wipe the disks clean in order to prevent system problems.



VMD Mode Selection

If you have installed the **Windows** OS with **VMD Mode** enabled, **DO NOT** disable the set mode (if you wish to disable the set mode you will need to reinstall the **Windows** OS).

Systems supporting **NVIDIA Advanced Optimus Capable Technology** can choose between the following display Modes.

- **MS Hybrid:** The system will **automatically** switch between the Integrated GPU and Discrete GPU as required.
- **Discrete GPU Only:** The system will only use the **Discrete GPU**.



Figure 5 - 8
Advanced Chipset Control > Display Mode (MS Hybrid)

Display Mode (Advanced Menu > Advanced Chipset Control)

The BIOS can be used to set the GPU display mode, and the settings available are dependent on the mode supported by your system.

Systems supporting **NVIDIA Advanced Optimus (For G-SYNC systems)** can choose between the following display modes.

- **Integrated GPU Only:** The system will use the **Integrated GPU**.
- **Discrete GPU Only:** The system will use the **Discrete GPU** in display mode.
- **Dynamic: (Default setting)** The system will **automatically** switch between the Integrated GPU and Discrete GPU as required, and the **NVIDIA Control Panel** will provide the user with three settings in **Manage Display Mode**.



Dynamic Mode

If your Advanced Optimus Dynamic Display Switching system is set to **Dynamic** (default) in the BIOS, then you can choose the Display Mode from the NVIDIA control panel (**Manage Display Mode**).

Figure 5 - 9
Advanced Chipset Control > Display Mode (Dynamic)



FlexiCharger Warning

If you leave the FlexiCharger continuously "Enabled" for a period of three months or more, the battery meter's reading accuracy will deteriorate.

To reset this, set the FlexiCharger to "Disabled", and then allow the battery to completely discharge (see "[Battery FAQ](#)" on page 3 - 24) before enabling the function again.

Figure 5 - 10
**Advanced Chipset
Control >
FlexiCharger**

FlexiCharger (Advanced Menu > Advanced Chipset Control)

The sub-menu here allows you to enable/disable the **FlexiCharger**. The FlexiCharger may be set to automatically start charging your battery when the battery reaches a certain capacity level (e.g. you could start the battery charge level at 40%).

You can then set the level to stop charging (e.g. 100%), and of course this stop charge level must be higher than the start charge level.

See the sidebar warning for information on running the FlexiCharger for an extended period as this is not recommended.



UEFI OS Fast Boot (Advanced Menu > Advanced Chipset Control)

Use this menu item to enable/disable the Fast Boot option, which when enabled, helps reduce the time it takes to boot the computer.

Battery Saver (Advanced Menu > Advanced Chipset Control)

When enabled *Battery Saver* can increase and extend battery life, but this can cause screen brightness to decrease.

USB Power Delivery Compatibility (Advanced Menu > Advanced Chipset Control)

You can set the Power Delivery power limit here (from Level 0 to Level 3) for the Thunderbolt 5 Port with Power Delivery DC-In. If you find that the external power source you are attempting to use is insufficient to power the computer, you can try using a different level setting.

Setup Utility - Security Menu



Security Menu

The changes you make here affect the access to the **BIOS** utility itself, and also access to your machine as it boots up after you turn it on. These settings do not affect your machine or network passwords which will be set in your software OS.

5



Figure 5 - 11
Security Menu

Set Supervisor Password (Security Menu)

You can set a password for access to the **BIOS**. This will not affect access to the computer OS (only the **BIOS**). An on-screen keyboard is available to assist with keyboard input.

Note: To clear existing supervisor passwords press **Enter** and type the existing password, then press **Enter** for the new password (without typing any password entry) and **Enter** again to confirm the password clearance. To clear a user password just click on **Clear User Password**.

Set User Password (Security Menu)

You can set a password for user mode access to the **BIOS**. This will not affect access to the computer OS, (only the **Setup** utility) unless you choose to set a **Password on Boot** (see below). Some menu items in the **BIOS** cannot be modified in user mode.

Note: *You can only set the user password after you have set the supervisor password.*

Power on Password: (Security Menu)

Specify whether or not a password should be entered to boot the computer (**you may only set a Power on Password if a supervisor password is enabled**). If “**Enabled**” is selected, only users who enter a correct password can boot the system (**see the warning in the sidebar**). The default setting is “**Disabled**”.



Password Warning

If you set a boot password (Password on boot is “Enabled”), **NEVER** forget your password.

The consequences of this could be serious. If you cannot remember your boot password you must contact your vendor and you may lose all of the information on your hard disk.

TPM Configuration (Security Menu)

This sub-menu will allow you to enable/disable Trusted Platform Module (TPM) support, and to configure the TPM State. Select **TPM Configuration** and press Enter to access the sub-menu. To reset the TPM select **Clear TPM** to clear existing TPM information (see *“Trusted Platform Module” on page 6 - 67*).

5

Figure 5 - 12
Security Menu
TPM Configuration



Setup Utility - Boot Menu

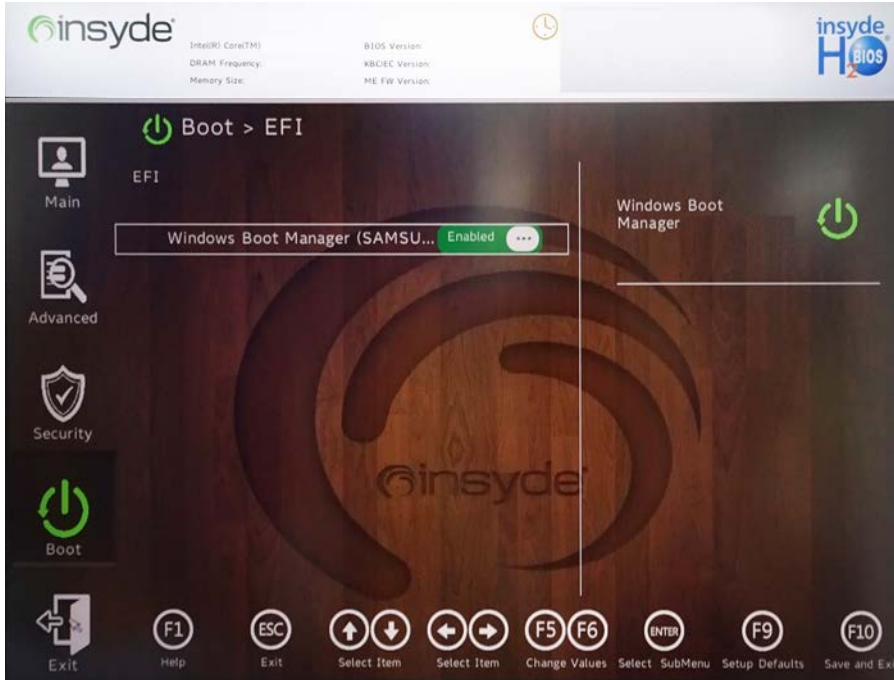

BIOS Screens

Note that the BIOS screens pictured on these pages are intended for guidance in setting up your system's BIOS.

BIOS versions are subject to constant change and revision, therefore your computer's actual screens may appear slightly different from those pictured on these pages.

5

Figure 5 - 13
Boot Menu

EFI (Boot Menu)

Press Enter to Enable/Disable any available device from which to boot under EFI.

UEFI Setting (Boot Menu)

The Unified Extensible Firmware Interface (UEFI) specification provides a clean interface between operating systems and platform firmware at boot time. In contrast to BIOS, UEFI defines a set of standard boot and runtime services. The **Network Stack** item can be enabled/disabled as an option under **UEFI Setting**.

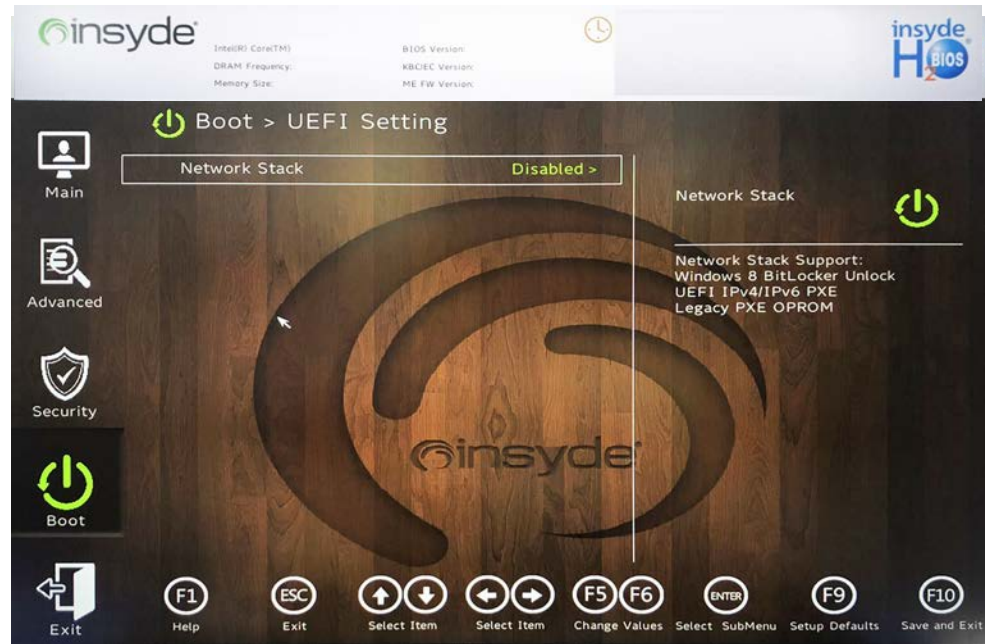

Figure 5 - 14
UEFI Setting

Setup Utility - Exit Menu



Click **Exit Saving Changes** (or press **F10**) to save all changes made and exit the BIOS. Choosing **Exit Discarding Changes** will wipe out any changes you have made to the **Setup** and exit the BIOS. You can also choose to **Load Optimal Defaults** (or press **F9**) to return the **BIOS** to its original state, and erase any previous changes you have made in a previous session. Select **Discard Changes** to cancel any changes made in the current session.

Battery Storage Setting

You can enable **Shipping Mode** for your battery if the system is battery powered and the battery level is reduced.

In this mode the battery will be locked to not power the system until first connected to the AC/DC adapter and initially set up as below:

Attach the AC/DC adapter cord to the DC-In jack at the rear of the computer, then plug the AC power cord into an outlet, and connect the AC power cord to the AC/DC adapter and the battery will now be unlocked.

Figure 5 - 15
Exit Menu

Chapter 6: Modules & Options

Overview

This chapter contains information on the following modules, which may come with your computer, depending on the configuration purchased. If you are unsure please contact your service representative.

- RAID Mode Setup
- Wireless LAN Module
- Killer Intelligence Center
- Intel® Speed Shift Technology Driver
- Intel® GNA Driver
- X-Rite Color Assistant
- Intel® Neural Processing Unit Driver
- Webcam Module
- IR (Hello) Camera
- Creative Sound Blaster Studio Pro 2 Audio
- Trusted Platform Module



Wireless Device Operation Aboard Aircraft

The use of any portable electronic transmission devices aboard aircraft is usually prohibited. Make sure the **WLAN & Bluetooth module(s)** are **OFF** (or the system is in **Airplane Mode**) if you are using the computer aboard aircraft (see [Table 1 - 4, on page 1 - 13](#)).



Enable VMD Controller

If you have installed the **Windows** OS with **VMD** mode enabled, **DO NOT** disable the set mode (if you wish to disable the set mode you will need to reinstall the **Windows** OS).

RAID Mode Setup

To configure your RAID (Redundant Array of Independent Disks) system in Striping (RAID 0), Mirroring (RAID 1) or Parity (RAID 5) modes (see [Table 6 - 1, on page 6 - 3](#)) you will require **at least two identical** (see sidebar) SSDs (**or three identical SSDs for RAID level 5**).



RAID Solid State Drives

All SSDs in a RAID should be identical (the same size and brand) in order to prevent unexpected system behavior.

VMD Mode Selection

The VMD mode selection should be made **before installing your operating system**.

DO NOT change your selected VMD mode unless you intend to reinstall your operating system. Make sure you have backed up all your data before doing so.

See [“Enable VMD Controller \(Advanced Menu\)” on page 5 - 15](#)

Make sure you install the **Intel® Optane™ Memory and Storage Management** application if you have set up your SSDs in **RAID** mode (see [“Intel® Neural Processing Unit Driver” on page 6 - 33](#)).

After enabling the VMD controller and installing the Intel® Rapid Storage Technology driver, DO NOT uninstall the Intel® Rapid Storage Technology driver.

RAID Level	Description
RAID 0	Identical drives reading and writing data in parallel to increase performance . RAID 0 implements a striped disk array and the data is broken into blocks and each block is written to a separate disk drive. A Striped Array (RAID 0) is NOT fault-tolerant. The failure of one drive will result in the loss of all data in the array. It is designed to increase disk performance by spreading the I/O load across the channels and drives.
RAID 1	Identical drives in a mirrored configuration used to protect data . Should a drive that is part of a mirrored array fail, the mirrored drive (which contains identical data) will handle all the data. When a new replacement drive is installed, data to the new drive is rebuilt from the mirrored drive to restore fault tolerance. A Mirrored Array (RAID 1) provides full data protection, as data can simply be copied from a healthy disk to a replacement for any failed disk.
RAID 5	RAID 5 (Parity) is the most regularly used secure RAID level , and it requires at least 3 drives . RAID 5 consists of block-level striping with distributed parity so data blocks are striped across the drives and parity data is not written to a fixed drive, but is spread across all drives. Using the parity data, the computer can recalculate the data of one of the other data blocks, should that data no longer be available. A RAID 5 array can withstand a failure of a single drive so that no data is lost.



SATA Mode Selection

The SATA mode selection should be made **before installing your operating system**.

DO NOT change your selected SATA mode unless you intend to reinstall your operating system. Make sure you have backed up all your data before doing so.

Solid State Drives

All solid state drives in a RAID should be identical (the same size and brand) in order to prevent unexpected system behavior.

Table 6 - 1
RAID Levels

RAID Setup

To configure your RAID (Redundant Array of Independent Disks) system in Striping (RAID 0), Mirroring (RAID 1) or Recovery modes (see *Table 6 - 1, on page 6 - 3*) you will require **two identical** solid state drives.

You need to setup a RAID before installing your *Windows* operating system, and you will need to prepare the following in order to do so.

-
- The *Microsoft Windows OS DVD*.
 - A connected external DVD drive.
 - Two Identical solid state drives.
 - The *Device Drivers & Utilities + User's Manual* disc.
 - A USB flash drive or external USB hard disk.
 - An operable computer (to copy files from the *Device Drivers & Utilities + User's Manual* disc to the USB flash drive or external USB hard disk).
-

Before setting up the system you will need to copy a driver folder to a USB flash drive. This driver folder is included on the *Device Drivers & Utilities + User's Manual disc* but you will need to go to an operable computer and copy the folder to a USB Flash drive.

1. Go to the operable computer and insert a USB Flash drive.
2. Insert the *Device Drivers & Utilities + User's Manual* disc into the CD/DVD drive of the operable computer.

- Copy the **f6vmdflpy-x64** folder from the location below (D: denotes your DVD drive) on the **Device Drivers & Utilities + User's Manual** disc to the USB flash drive or external USB hard disk.

- D:\Options\RAID\F6Drivers**

- Start up your notebook computer and press <F2> to enter the **BIOS** and go to the **Setup Utility**.
- Select the **Advanced** menu.
- Select **Enable VMD controller** (see page **5 - 15**), and select "**Enabled**".
- Press <F10> to "**Save and Exit**" and select <Yes>.
- As the computer restarts press <F2> to enter the **BIOS** again and go to the **Setup Utility**.
- Select the **Advanced** menu.
- Go to **Intel(R) Rapid Storage Technology (Advanced menu)** and select "**Create RAID Volume**".

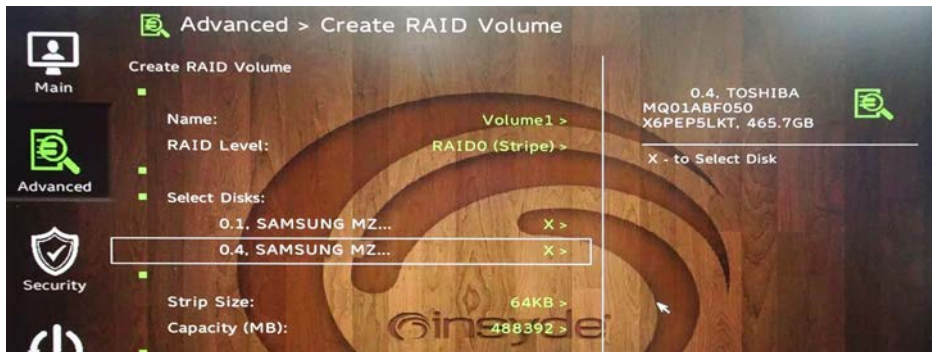

Figure 6 - 1
Create RAID Volume

11. You can now setup your RAID volume using the installed SSDs.
12. Select “**Name**” and type a name of your choice for your RAID volume and select <Yes>.

Figure 6 - 2
RAID Name



13. Select **RAID Level** and choose the RAID Level required (see [Table 6 - 1](#), on [page 6 - 3](#) for details) and press <Enter>.
- **RAID0 (Stripe)**
 - **RAID1 (Mirror)**
 - **RAID 5 (Parity)**

14. Go to any of the disks listed under “**Select Disks:**” and select a disk name.
15. Click on **X** to select the disk required.



Figure 6 - 3
Select Disks

16. You should select two or three identical SSDs (three SSDs are required for RAID 5) to form your RAID volume.
17. If you have selected **RAID0 (Stripe)** then you can adjust the “**Strip Size**” to (you can use the cursor to move up and down the menu selection) your requirements (*it is recommended that you set the “Strip Size” to 128KB*).
18. Select **Create Volume** (make sure you have selected your disks).
19. The system will list your RAID volume.

20. Press <F10> to “**Save and Exit**” and select <Yes>, however note the bulleted points below.
 - Make sure the **Windows** OS DVD is in the attached DVD drive or on a USB flash drive, as the computer starts up it will automatically boot from the **Windows 10** OS DVD (you will be prompted to press a key to boot from the DVD/USB flash drive).
 - Make sure your USB Flash drive, or external USB hard disk, containing the **f6vmdflpy-x64** folder previously copied from the **Device Drivers & Utilities + User’s Manual disc** is attached to one of the computer’s USB ports.
21. Press <F2> as the computer starts up to select the drive containing the **Windows** OS DVD/USB flash drive as the boot device in **Boot Manager**.
22. Press a key at system startup to begin installing **Windows** from your **Microsoft Windows** drive.
23. Click **Next > Install Now** to continue installing the operating system as normal (see your **Windows** documentation if you need help on installing the **Windows** OS).
24. If no installation drives appear “**Where do you want to Install Windows?**” window, click **Load Driver** from the menu at the bottom.
25. Click **Browse** and browse to the location you copied the files to on your USB Flash drive or external USB hard disk (X: denotes your USB Flash drive or external USB hard disk):
 - **X:\Drivers**
26. **Click to select either one of the driver names.**

27. Click **Next**.
28. Follow the on-screen instructions to install the **Windows** operating system.
29. Install the **Windows** drivers from the **Device Drivers & Utilities + User's Manual** disc as per **Table 4 - 1, on page 4 - 4** (make sure you install the **Intel Rapid Storage Technology driver** - see overleaf).
30. Run the **Intel® Optane™ Memory and Storage Management** application to manage your RAID volume as instructed in "**Intel® Neural Processing Unit Driver**" on page 6 - 33.

Deleting a RAID

If you wish to delete an existing RAID then follow the procedure below to do so. However **backup up any necessary files and data before deleting a RAID**, as doing so will result in the loss of all data on the RAID volumes.

1. Start-up your notebook computer and press <F2> to enter the **BIOS**.
2. Select **Intel(R) Rapid Storage Technology** (in the **Advanced** menu).
3. Select the RAID (listed under **RAID Volumes:**).
4. Select **Delete**.
5. Select **“Yes”** (note that all the data on the volumes will be lost).

6

Figure 6 - 4
Delete RAID



Wireless LAN Module

If your purchase option includes a **Combination Wireless LAN & Bluetooth module** (either **Intel®** or **Killer**) then install the driver for the appropriate module as instructed below.

- See “*Intel® WLAN Driver Installation*” on page 6 - 12.
- See “*Killer WLAN Combo Driver Installation*” on page 6 - 13.

Make sure that the module is on (i.e. the system is not in **Airplane Mode**) before installing the driver. Make sure you install the drivers in the order indicated in *Table 4 - 1, on page 4 - 4*.

Note that you need to install both the WLAN & Bluetooth drivers for the WLAN & Bluetooth Combo modules.



Wireless Device Operation Aboard Aircraft

The use of any portable electronic transmission devices aboard aircraft is usually prohibited. Make sure the **WLAN & Bluetooth module(s)** are **OFF** if you are using the computer aboard aircraft by putting the system in to **Airplane Mode** (see *Table 1 - 4, on page 1 - 13*).



Uninstalling The WLAN Driver

Note that if you need to uninstall the WLAN driver, and it does not appear in the *Programs and Features control panel*, you will need to do so from the Device Manager.

To uninstall the driver from Device Manager, right-click the Start Menu icon  in the taskbar and select **Device Manager**. Right-click the WLAN device and then select **"Uninstall device"** (make sure to tick the box **"Delete the driver software for this device"**) to start the process.

After the driver is uninstalled click the icon  at the top of Device Manager to "Scan for hardware changes".

Intel® WLAN Driver Installation

1. **Make sure the system is not in Airplane Mode**, and then insert the *Device Drivers & Utilities + User's Manual* disc into an attached DVD drive.
2. Click **Option Drivers** (button).
3. Click **1.Install WLAN Driver > Yes**.
4. Click **Next**.
5. Click in the check box to agree to the **End User License Agreement** and click **Install**.
6. Click **Finish**.
7. The operating system is the default setting for Wireless LAN control in *Windows* (see page **6 - 14**).

Killer WLAN Combo Driver Installation

1. **Make sure the system is not in Airplane Mode**, and then insert the *Device Drivers & Utilities + User's Manual* disc into the DVD drive.
2. Click **Option Drivers** (button).
3. Click **1.Install WLAN Driver > Yes**.
4. Select the language preferred and click **Next**.
5. Click **Next > Next**.
6. Click in the check box to accept to the **License Agreement** and click **Next**.
7. Click **Finish**.
8. Click **Yes** to restart the computer.
9. The operating system is the default setting for Wireless LAN control in *Windows* (see page **6 - 14**).
10. **If you have not downloaded the Killer Intelligence Center App as part of the LAN installation (see page 4 - 8), you can do so from the Microsoft Store** but you will need to have a working internet connection.
11. After the driver is installed an automatic browser window will pop-up and you can click the “**Get**” button to start the installation.
12. Alternatively click the **Start** menu in Windows to access the **Microsoft Store App** tile.
13. You can then search by typing “**Killer Intelligence Center**” in the search window (click the magnifying glass icon in the top right corner of the screen) and click to install the App.
14. When installed the **Killer Intelligence Center** will appear in the **Windows Start** menu.



Uninstalling The WLAN Driver

Note that if you need to uninstall the WLAN driver, and it does not appear in the *Programs and Features control panel*, you will need to do so from the Device Manager.

To uninstall the driver from Device Manager, right-click the Start Menu icon  in the taskbar and select **Device Manager**. Right-click the WLAN device and then select “**Uninstall device**” (*make sure to tick the box “Delete the driver software for this device”*) to start the process.

After the driver is uninstalled click the icon  at the top of Device Manager to “Scan for hardware changes”.





Connect Automatically

It is recommended that you check the box to **Connect automatically**.

This will cause the system to check for the access point upon startup, and resuming from a power-saving state, and will remove any necessity to keep connecting manually.

WLAN Configuration in Windows

You can configure a wireless connection using one of the following options, however make sure the Wireless LAN module is turned on (and not in Airplane Mode) before configuration begins.

1. Click the Wireless icon   in the notification area of the taskbar.
2. Make sure that **Airplane mode is off** (the Airplane mode icon should be gray).
3. Click the **Manage Wi-Fi connections** icon and a list of available access points will appear.
4. Double-click an access point to connect to it (or click it and click **Connect**).

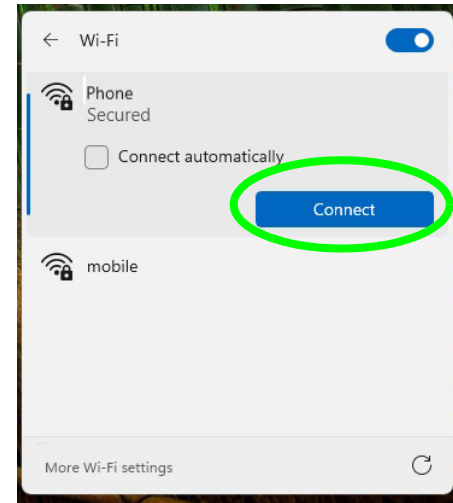
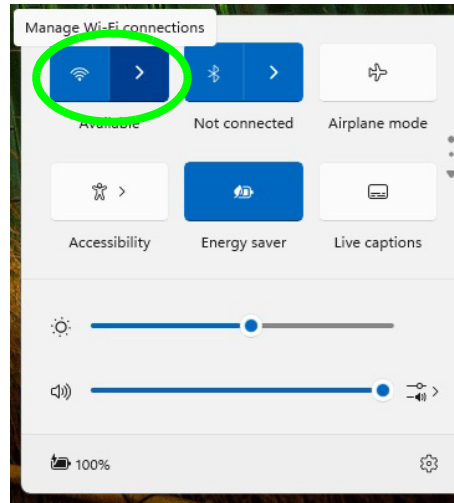

Figure 6 - 5 -
WiFi & Network
Connections

5. Enter a network security key (password) if required, and click **Next**.
6. You can choose to share or connect to devices or not.
7. When you are connected to the network access point it will display its **connected** status under the name of network.
8. Select any connected network and click **Disconnect** to disconnect from a connected access point.



**Wireless Device
Operation Aboard Aircraft**

The use of any portable electronic transmission devices aboard aircraft is usually prohibited.

Make sure the module is either **OFF** or in **Airplane mode** if you are using the computer aboard aircraft.

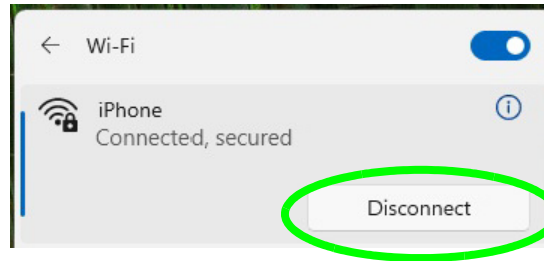

Figure 6 - 6
**Network Connected
(Click Disconnect)**

9. You can click the **Airplane Mode** button in the Action Center to turn the mode On or Off.
10. You need to either use **Airplane Mode**, or to **turn the WLAN module off** aboard aircraft.

11. Click on **Network & Internet** (in **Settings**) for a more comprehensive list of network and internet settings including **Wi-Fi** (can be turned on/off), **Ethernet**, **VPN**, **Mobile Hotspot**, **Airplane mode** (Airplane mode and Wireless devices can be turned on/off) **Proxy**, **Dial-up** and **Advanced Network Settings**.

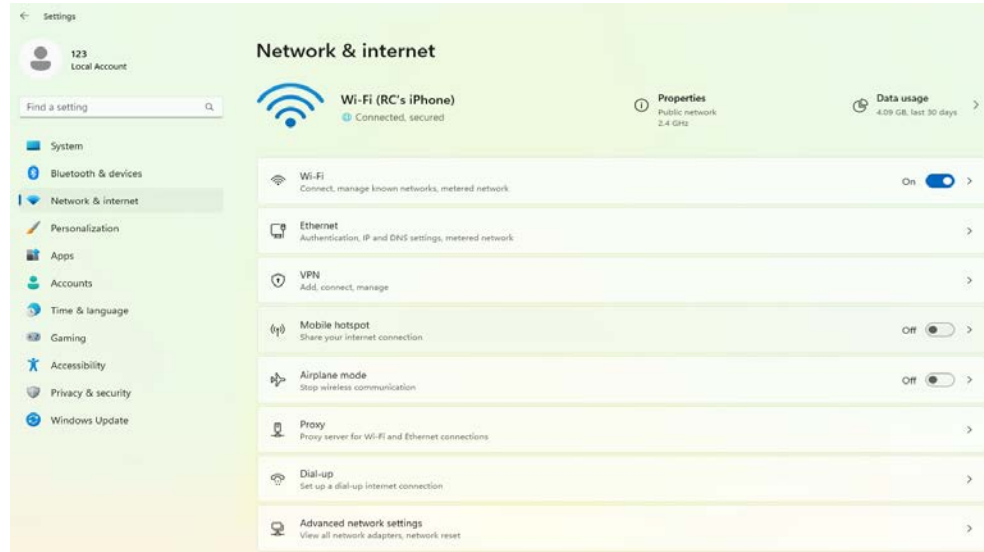



Figure 6 - 7
**Network & Internet
Settings**

Killer Intelligence Center

The **Killer Intelligence Center** app can be accessed from the desktop  or Apps menu (if the app is not installed then app from the Microsoft Store but you will need to have a working internet connection). The app helps you to manage your network performance, optimize connection speed, and to control which applications are using your wireless bandwidth.

Dashboard

The **Dashboard** page displays current network traffic received by the system in real time, status, WiFi score by access point and quick setting options etc

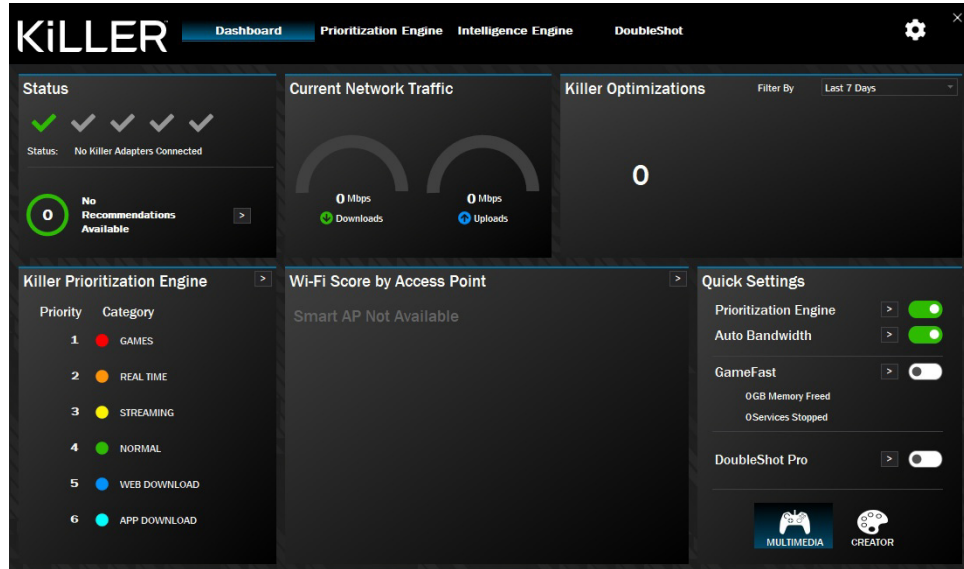

Figure 6 - 8
Killer Intelligence Center (Dashboard)

Prioritization Engine

The **Prioritization Engine** can be set (click the arrows on the left of each row) for each application or domain with Priority 1 the highest, and 6 the lowest.

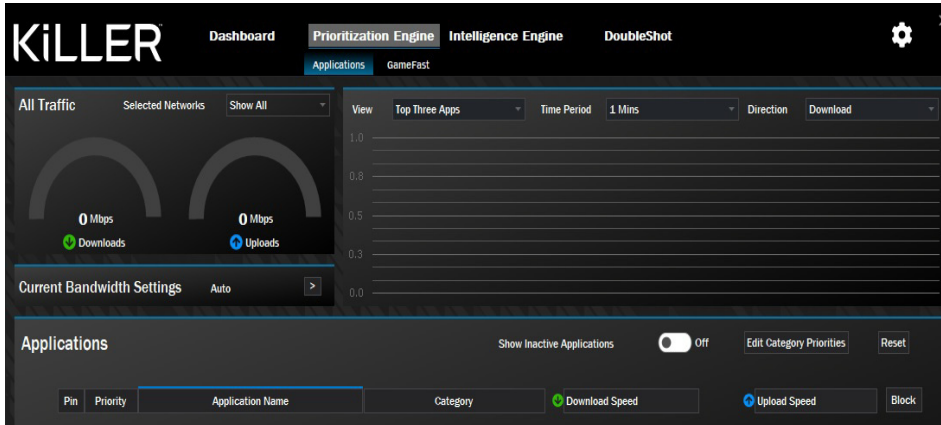

Figure 6 - 9
Killer Intelligence Center
(Prioritization Engine)

The **Killer Intelligence Engine** can improve networking performance by allowing you to set bandwidth limits and monitor access points, and it ensures that critical traffic goes through the best interface etc.

You can use **GameFast** to pause services so that games can use network resources to perform optimally.

The **Settings** page provides an overview of the network information for the Killer adapter.



Wireless Device Operation Aboard Aircraft

The use of any portable electronic transmission devices aboard aircraft is usually prohibited. Make sure the **WLAN & Bluetooth module(s)** are **OFF** if you are using the computer aboard aircraft by putting the system in to **Airplane Mode** (see [Table 1 - 4, on page 1 - 13](#)).

6

Bluetooth Module

If your purchase option includes the **Combination Wireless LAN & Bluetooth module** then install the driver as instructed overleaf.

Make sure that the module is on (i.e. the system is not in **Airplane Mode**) before installing the driver.



Bluetooth Data Transfer

Note that the transfer of data between the computer and a Bluetooth enabled device is supported in one direction only (simultaneous data transfer is not supported). Therefore if you are copying a file from your computer to a Bluetooth enabled device, you will not be able to copy a file from the Bluetooth enabled device to your computer until the file transfer process from the computer has been completed.

Note that you need to install both the WLAN & Bluetooth drivers for the WLAN & Bluetooth Combo modules.

Intel & Killer Bluetooth Combo Driver Installation

The Bluetooth drivers for both modules are installed as below.

1. **Make sure the system is not in Airplane Mode**, and then insert the *Device Drivers & Utilities + User's Manual* disc into an attached DVD drive.
2. Click **Option Drivers** (button).
3. Click **2.Install Combo BT Driver > Yes**.
4. Click **Next**.
5. Click in the check box to accept the license and click **Next**.
6. Select the setup type (**Typical** is recommended) and click **Install**.
7. Click **Finish**.
8. See *“Bluetooth Configuration in Windows” on page 6 - 22* for configuration instructions.



Uninstalling The WLAN / Bluetooth Combo Driver

Note that if you need to uninstall the WLAN / Bluetooth driver you will need to do so from the Device Manager (and **not** from the Programs and Features control panel).

Bluetooth Configuration in Windows

1. Go to the **Settings** control panel and click **Bluetooth & devices** (or click the Bluetooth icon  in the taskbar and click **Add a Bluetooth Device**).
2. Make sure Bluetooth is **On**.
3. Click **Add device** and a list of discovered devices will appear.

Figure 6 - 10
Settings > Bluetooth & devices (Add Device)



- Double-click the device you want to pair with the computer and click **Connect**, if the PIN matches that on the device to which you wish to connect (you may need to click pair on the device).

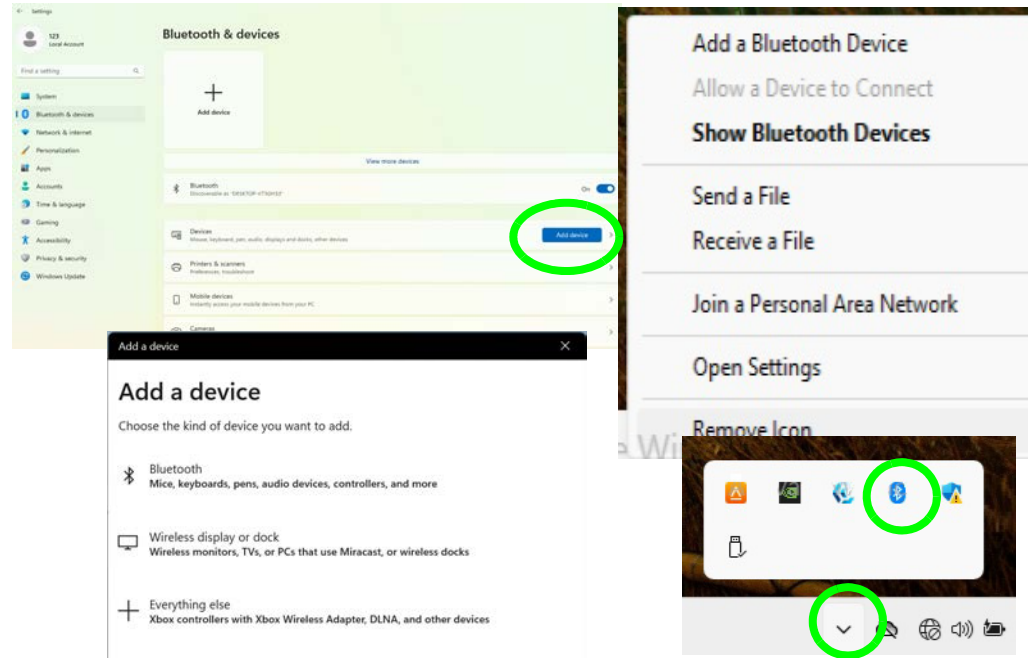
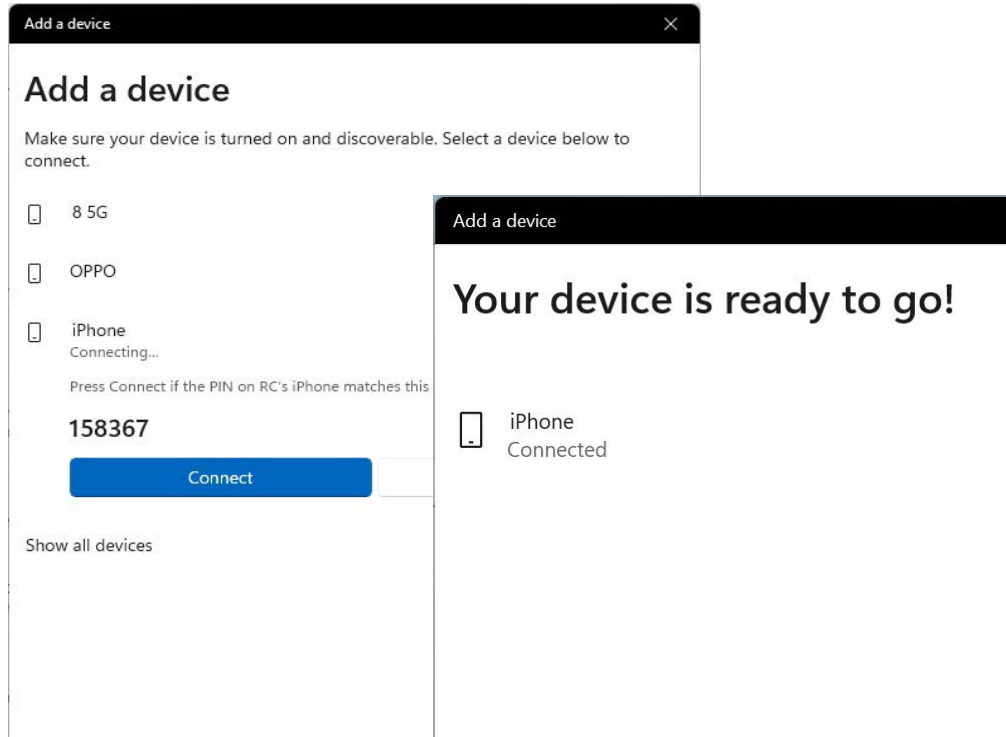
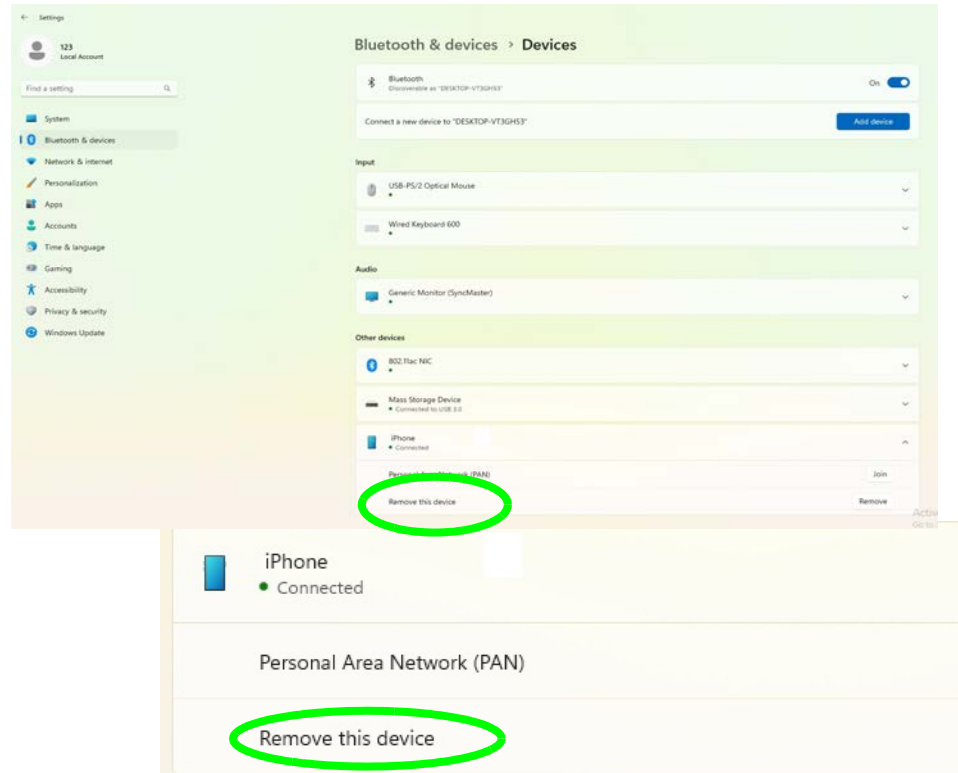

Figure 6 - 11
Bluetooth Connect

Modules & Options

5. Select a device and click **Remove this device** to disconnect from any device (click **Yes** to confirm).

Figure 6 - 12
**Bluetooth - Remove
This Device**



To Make Your Computer Discoverable to Bluetooth Devices

1. Go to the **Settings** control panel and click **Bluetooth & devices** (or click the Bluetooth icon  in the taskbar and click **Open Settings**).
2. Click the arrow in **Devices** and scroll down to click **More Bluetooth options**.
3. In **Bluetooth Settings** make sure that **Allow Bluetooth devices to find this PC** check box (**Discovery**) has a check inside it.
4. Make sure that the **Alert me when a new Bluetooth device wants to connect** check box (**Notifications**) has a check inside it, if you want to be notified when a Bluetooth device wants to connect.

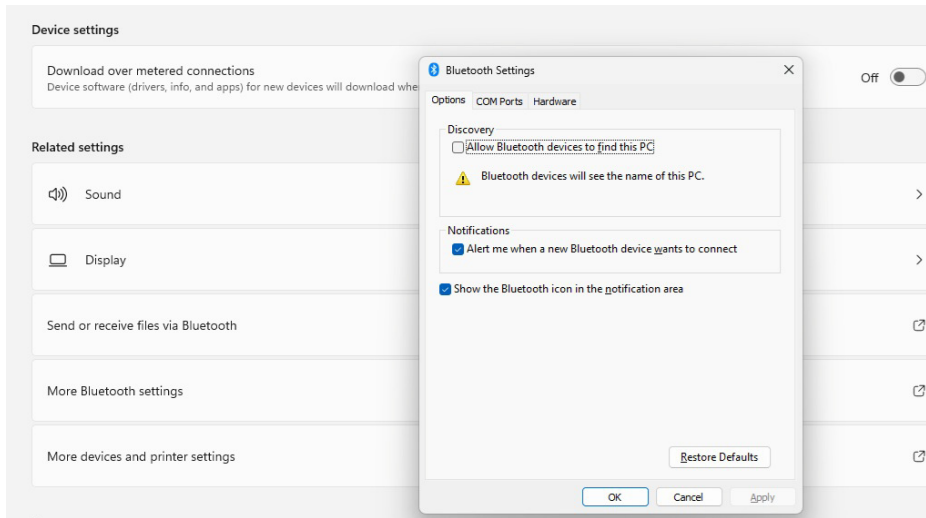

Bluetooth Taskbar Icon

If you do not see the Bluetooth Icon in the notification area of the taskbar, click on **More Bluetooth options** and click to put a check in the box “**Show the Bluetooth icon in the notification area.**”

Figure 6 - 13
Bluetooth Settings



*P-States

P-states are voltage-frequency pairs that set the speed and power consumption of the coprocessor.

When the operating voltage of the processor is lower, so is the power consumption.

Intel® Speed Shift Technology Driver

Install the **Intel® Speed Shift Technology** driver as outlined below. Speed Shift Technology allows operating system to hand off some or all control of the handling of the computer's *P-States to the processor. This has a couple of noticeable benefits in responsiveness and the reduction of power consumption.

Speed Shift Technology Driver Installation

1. Insert the *Device Drivers & Utilities + User's Manual* disc into an attached DVD drive.
2. Click **Option Drivers** (button).
3. Click **3.Install Speed Shift Driver > Yes**.
4. Click **OK > OK**.
5. This will complete the installation procedure.

X-Rite Color Assistant

(For systems supporting the Pantone Certificate only)

If your system supports the Pantone Certificate then you can install the **X-Rite Color Assistant** application as instructed below. The X-Rite Color Assistant application allows you to calibrate the screen for optimum color display.

X-Rite Color Assistant Installation

1. Insert the *Device Drivers & Utilities + User's Manual* disc into an attached DVD drive.
2. Click **Option Drivers** (button).
3. Click **4.Install Xrite Color Assistant > Yes**.
4. Select the setup language and click **OK**.
5. Click **Next**.
6. Click the check box to accept the terms of the license agreement and then click **Next**.
7. Click **Next > Install > Finish**.
8. Run the **X-Rite Color Assistant app** from the **Apps** screen to calibrate the screen (there should also be a desktop icon), and if running then access the application from the icon in the taskbar's System Tray. The application contains four items (see the following pages).
9. Right-clicking the taskbar icon will bring up the Quick Selection menu and you can choose a profile from the menu.

Preview

You can select a **Profile** to change the screen color, and you view the difference in the changed screen color from the picture on the right.

6

Figure 6 - 14
X-Rite Color Assistant Preview

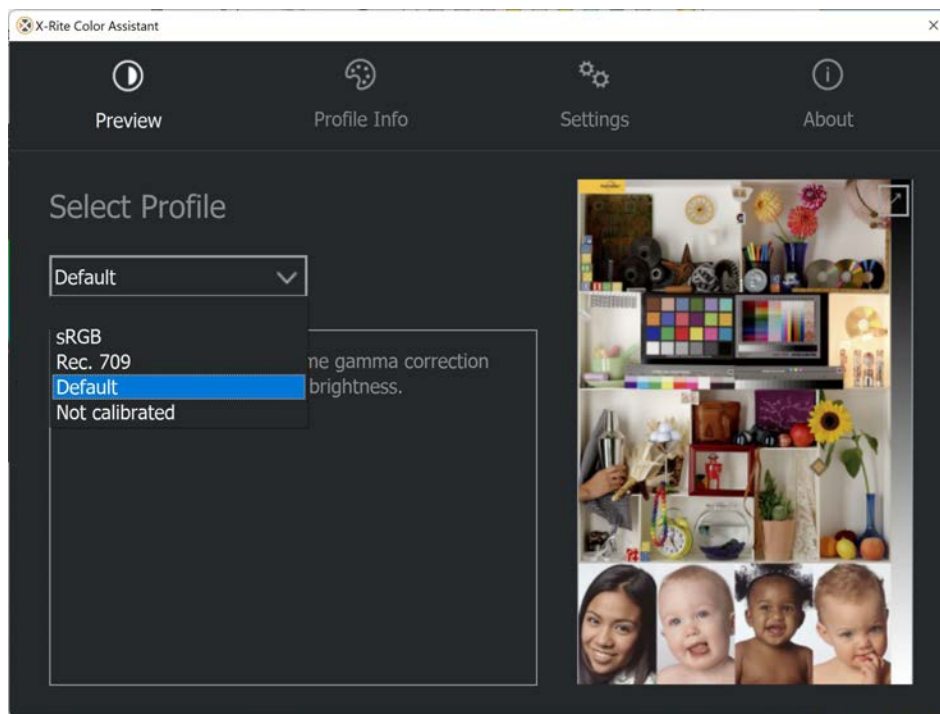

Profile Info

This tab provides more detailed information on the profiles.

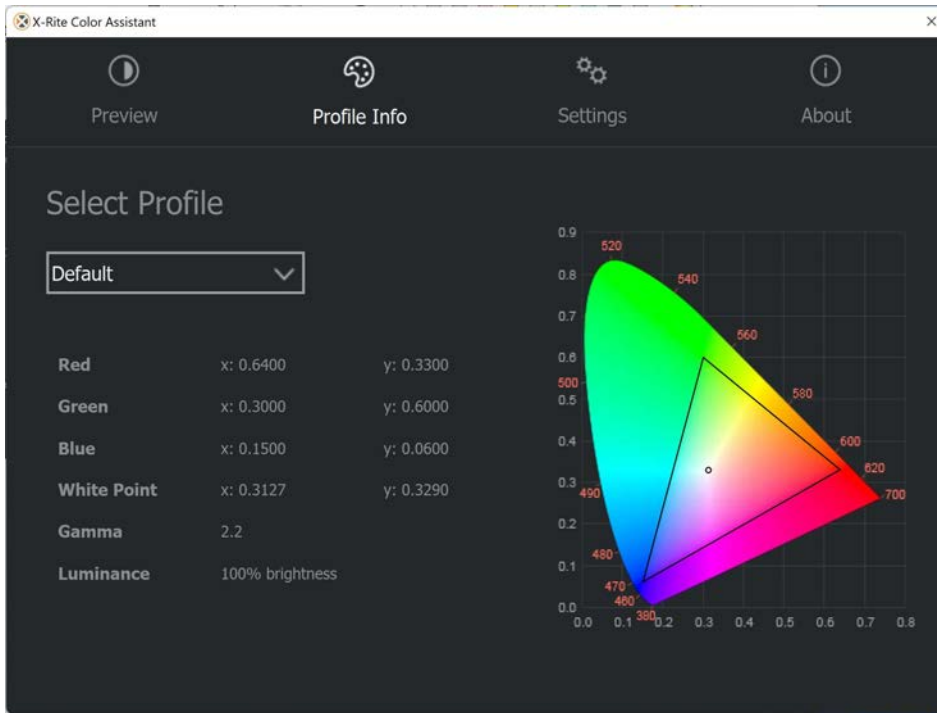
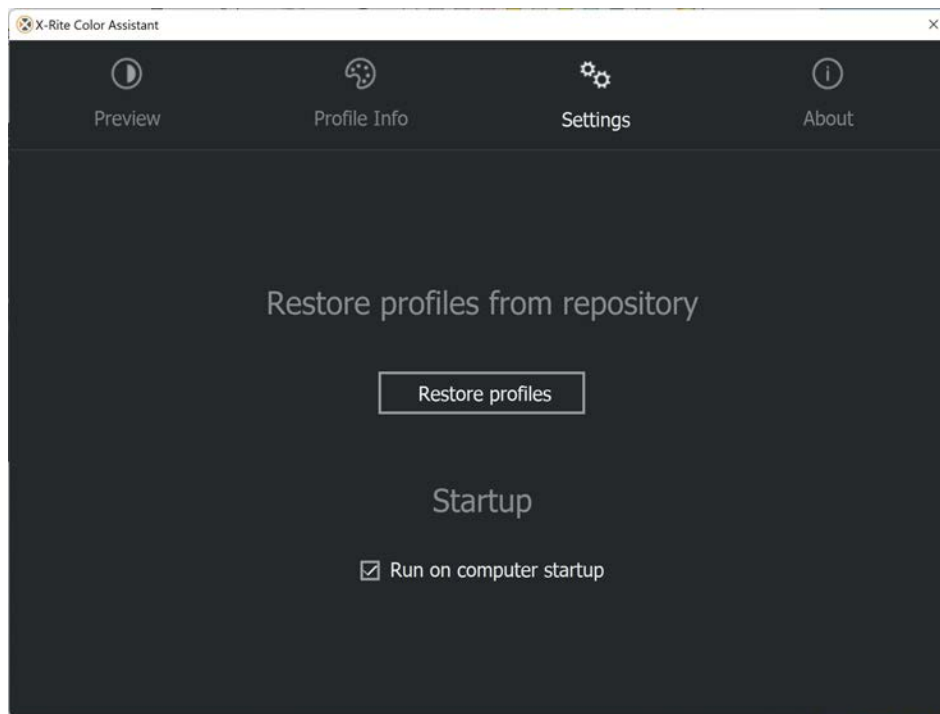

Figure 6 - 15
X-Rite Color
Assistant Profile
Info

Settings

The Settings tab can be used to restore customized Profiles.



6

Figure 6 - 16
**X-Rite Color
Assistant Settings**

About

The about tab displays information about this software.

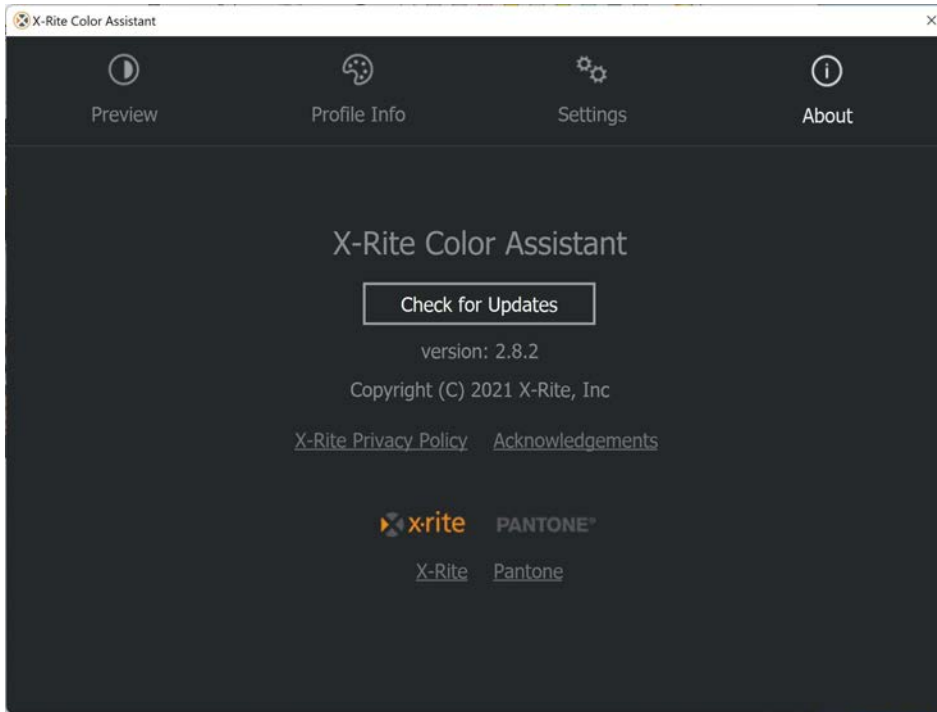

Figure 6 - 17
X-Rite Color
Assistant About

Intel® GNA Driver

Install the **Intel® GNA Driver** for your processor. The Intel® Gaussian & Neural Accelerator (Intel® GNA) is designed to support a small coprocessor in your system that is responsible for accelerating certain Deep Learning algorithms.

Intel® GNA is designed to offload certain continuous workloads including noise reduction or speech recognition, and therefore saves power and frees up CPU resources for overall system performance and responsiveness.

Intel GNA Driver Installation

1. Insert the *Device Drivers & Utilities + User's Manual* disc into an attached DVD drive.
2. Click **Option Drivers** (button).
3. Click **4./5.Install GNA Driver > Yes**.
4. Click **OK > OK** to complete the installation.

Intel® Neural Processing Unit Driver

An Intel® NPU device is specialized low power microprocessor optimized for enabling energy-efficient execution of artificial intelligence (AI) neural networks tasks such as sorting and object tracking. The NPU can free up the CPU and GPU when performing repetitive tasks. Install the driver below to support this.

Intel NPU Driver Installation

1. Insert the *Device Drivers & Utilities + User's Manual* disc into an attached DVD drive.
2. Click **Option Drivers** (button).
3. Click **5./6.Install Intel NPU Driver > Yes**.
4. Click **OK** (the prompt will pop-up several times so keep clicking it until it disappears) to complete the installation.

Intel® Platform Monitoring Technology Driver

The Intel Platform Monitoring Technology (PMT) driver is a hardware monitoring tool designed to help the system detect power consumption issues and improve application performance.

Intel PMT Driver Installation

1. Insert the *Device Drivers & Utilities + User's Manual* disc into an attached DVD drive.
2. Click **Option Drivers** (button).
3. Click **6./7.Install Intel PMT Driver > Yes**.
4. Click **Restart Now** to complete the installation.

Webcam Module

When the Camera application is run the camera LED indicator will be illuminated (see [2 Figure 1 - 3 on page 1 - 8](#)). Note that you need to use the **Camera** app in *Windows* to take pictures and capture video. Use the **Fn + F10** key combination (see *“Function/Hot Key Indicators” on page 1 - 13*) to toggle power to the webcam module.

Note that you need to use the **Camera** app  in *Windows* to take pictures and capture video. Install the driver as below:

Webcam Driver Installation

1. Insert the *Device Drivers & Utilities + User's Manual* disc into an attached DVD drive.
2. Click **Option Drivers** (button).
3. Click **7./8.Install Camera Driver > Yes**.
4. Click **OK** (the prompt will pop-up several times so keep clicking it until it disappears) to complete the installation.





Camera Access

You can change the options for camera access by going to the **Privacy & Security** menu in **Settings**, and selecting **Camera** under **App Permissions**.

You can turn camera access on or off, and specify which apps have access to the camera.

Camera App

1. Make sure the webcam is turned on by using the **Fn + F10** key combination (or **Control Center button**).
2. Run the Camera app from the Start menu by clicking All Apps and then by clicking on the **Camera** app icon  (you can type "camera" into the search box to find the Camera app).
3. It is recommended that you pin the **Camera** app  to the Start menu.

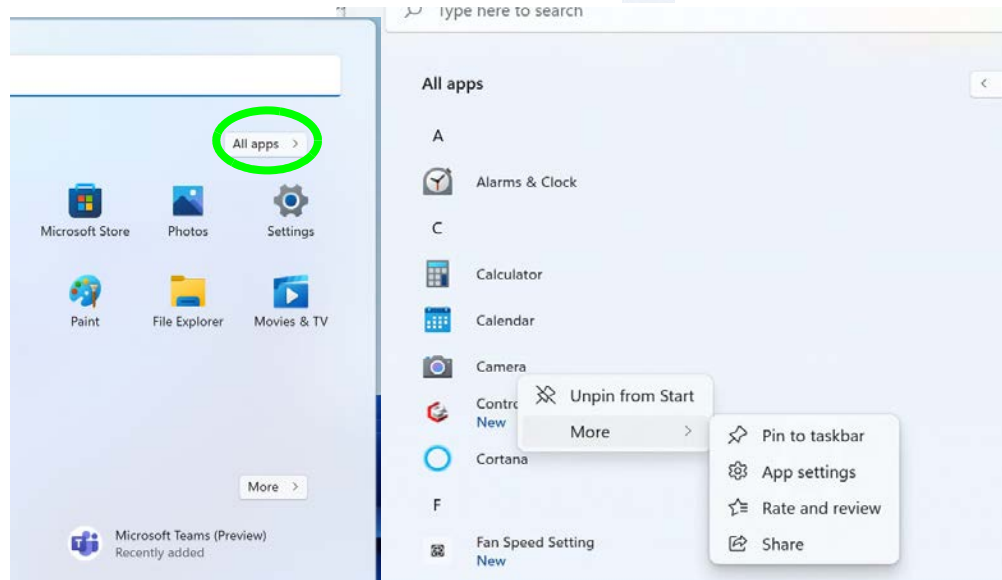

Figure 6 - 18
All Apps - Camera

- The interface displays three buttons on the right of the screen; one for photo, one for video and one for Barcode.

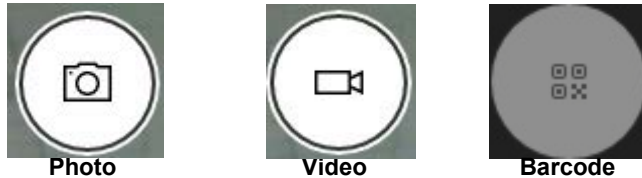



Figure 6 - 19
Camera App Mode Icons

- Simply click on the appropriate button (or arrow) to switch to either photo, video or barcode reader modes.
- You can use the buttons on the left of the screen to access the **Settings**, **Brightness**, **HDR** and **Photo Timer**.

Advanced Controls On/Off

The menu buttons displayed on the left side of the screen will depend on the photo mode chosen in **Settings** . **With advanced controls enabled for Photo**, the **Photo timer** and **Brightness** buttons will appear, and with **advanced controls disabled** the **Photo timer** and **HDR** buttons will be displayed. With advanced controls enabled for Video, the Brightness button will be displayed.

The **Photo Timer** can be set to take Photos after **2, 5 or 10 seconds**.



Figure 6 - 20
Camera Menu Buttons

Modules & Options

- Click **Settings**  to access the camera settings menu to select/deselect **Advanced Controls**, make adjustments for **Framing grid**, **Photo Quality**, **Time lapse**, **Video Quality** and **Flicker reduction** (*you can also access the system settings for the camera and audio by using the links*).

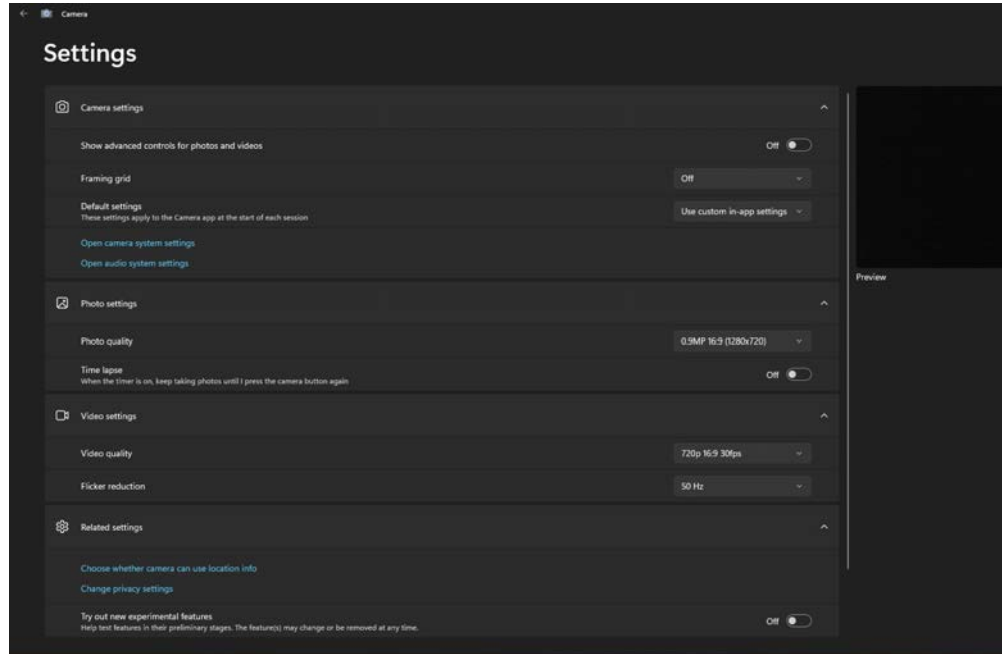

6

Figure 6 - 21
Camera Settings



Camera Settings

You can use a **Framing grid** to help you line up pictures.

The **Photo Quality** can be changed to that which the system supports.

Time lapse can be set to keep taking photos until the camera button is pressed again.

The **Video Quality** resolution and frame rate can be set to any supported by the system. Note that capturing high resolution video files requires a substantial amount of disk space for each file. After recording video, check the video file size (right-click the file and select Properties) and the remaining free space on your hard disk (go to File Explorer, right-click the hard disk, and select Properties). If necessary you can remove the recorded video file to a removable medium e.g. a USB Flash drive.

If you need to reduce any screen flicker, change the settings in **Flicker reduction** to either e.g. 50Hz or 60Hz.







8. With the **Advanced Controls** enabled (in Settings ) you can access the **Brightness** button to adjust the brightness.
9. With **Advanced Controls** disabled you can toggle **HDR** on (**Pro**) or off.



Figure 6 - 22
Camera Brightness Adjustment
 (Advanced Controls Enabled)

Taking Pictures/Capturing Video

1. Make sure the webcam is turned on by using the **Fn + F10** key combination (or **Control Center button**).
2. Run the Camera app from the Start menu by clicking on the **Camera** app icon  (you can type “camera” into the search box to find the Camera app).
3. Click to select either **photo**  or **video**  modes.
4. Click the photo icon to take a picture.
5. Click on the video icon  to start video capture (when video capture begins a timer will appear at the bottom of the screen).
6. To stop video capture click the stop  button (you can also pause  the video capture).

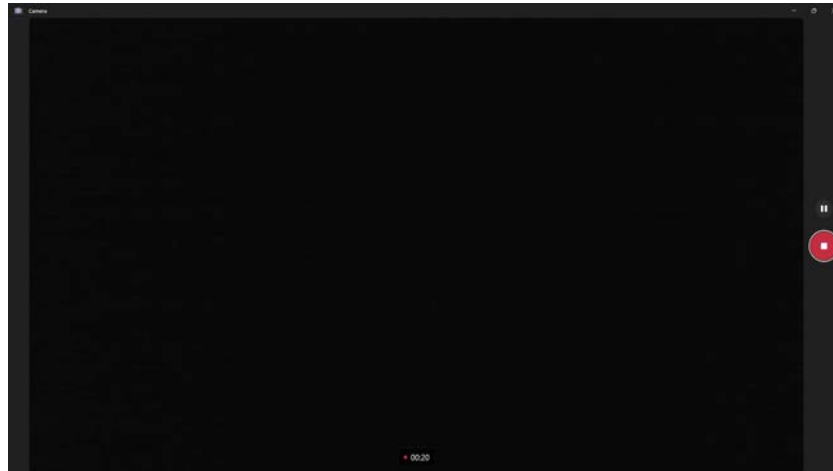

Figure 6 - 23
**Video Camera
Recording in
Process**

- Captured photos and videos will be saved to the **Photos** app stored in the Start menu (type **Photos** into the search box if you cannot find the app). You can also access the photos from the **Camera roll** icon at the bottom right of the Camera app screen.

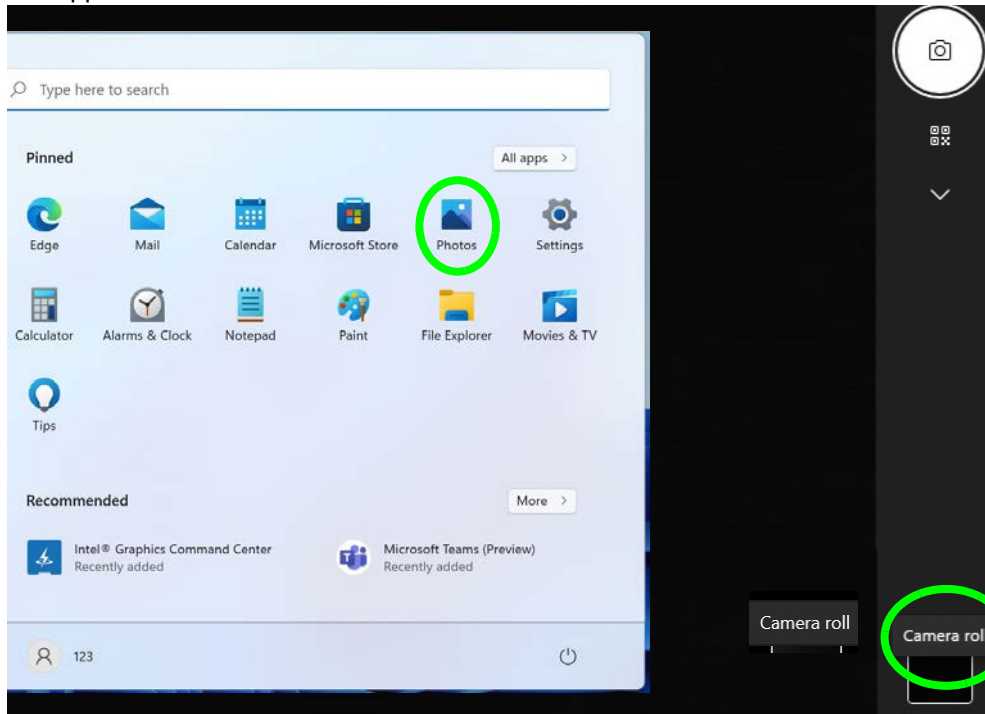

Figure 6 - 24
Photos App
(For Captured
Photos & Videos)
&
Camera Roll in the
Camera App

IR (Hello) Camera

The **Infrared camera** is compatible with the **Windows Hello facial recognition** system. The IR Camera provides a user-friendly interface with a single form of verification to log on to your computer.

The IR Camera module uses the **Sign-in options** configuration of the **Windows Account**. Install the driver as below if you have not already installed it:

Webcam Driver Installation

1. Insert the *Device Drivers & Utilities + User's Manual* disc into an attached DVD drive.
2. Click **Option Drivers** (button).
3. Click **7./8.Install Camera Driver > Yes**.
4. Click **OK** (the prompt will pop-up several times so keep clicking it until it disappears) to complete the installation.

Hello Camera Module Configuration

1. Before setting up the facial recognition system make sure that:
 - The system is powered by the AC/DC adapter (if the system is powered by the battery then facial recognition will not work).
 - If you are a glasses wearer then it is recommended that you remove your glasses in order to prevent reflection problems hampering the facial recognition system.
2. Click the **Settings** item in the Start Menu and then click **Accounts** and click **Sign-in options**.
3. You will need to add a **Windows** password (click **Add** under **Password**).
4. After you have added the password you will need to also add a **PIN**.
5. Click **Set up** under **Windows Hello Face**.
6. Click **Get Started** and the Windows Hello Setup Wizard will then guide you through the set up process to scan your face.
7. You will need to key in the pin number on initial setup.
8. Before the scanning process begins, once again note:
 - The system is powered by the AC/DC adapter (if the system is powered by the battery then facial recognition will not work).
 - If you are a glasses wearer then it is recommended that you remove your glasses in order to prevent reflection problems hampering the facial recognition system.
9. Keep looking directly at the screen and the system will scan your face (the blue bar underneath your picture indicates the progress of the scan).
10. The system will then prompt with “**All Set!**”, so click **Close** to exit the Setup Wizard.



Facial Scanning with Glasses

If you set up Windows Hello without glasses, as recommended, then you can select **Improve recognition** to try the setup again with them on (reflection problems from glasses will sometimes hamper the recognition).

Modules & Options



Hello Camera and Power-Saving

If you turn off the Camera (e.g. by using the **Fn + F10** key combination) then the facial recognition system will not function.

If the system enters and resumes from Sleep mode with the camera turned off, then the facial recognition system will not function.

11. **Restart the computer** after the scanning process has been completed.
12. You can use the facial recognition system to unlock your computer the next time you start the system. The system will prompt with “**Getting ready...**” and after seeing this simply look directly (as it prompts “**Looking for you...**” / “**Making sure it's you..**”) at the screen to complete the scan.

Intel® Rapid Storage Technology

Install the **Intel® Rapid Storage Technology** driver to support your **RAID** system, if your **BIOS** is set with **VMD** mode enabled (see “*Enable VMD Controller (Advanced Menu)*” on page 5 - 15).

IRST Driver Installation

1. Insert the *Device Drivers & Utilities + User's Manual* disc into an attached DVD drive.
2. Click **Option Drivers** (button).
3. Click **8./9.Install IRST Driver > Yes**.
4. Click **Next**.
5. Click in the check box to accept the license and click **Next**.
6. **Next > Next**.
7. Click **Restart** to restart the computer.
8. Run the **Intel® Optane™ Memory and Storage Management application** app from the **Apps** screen.

See the following pages for more information if you have set your system for a **RAID**. **After setting the SATA mode to Intel® Optane™ and installing the Intel® Rapid Storage Technology application, DO NOT uninstall the IRST driver or Intel® Optane™ Memory and Storage Management application.**



Driver Uninstall Warning

After setting the VMD mode to Intel® Optane™ and installing the IRST driver and Intel® Optane™ Memory and Storage Management application, **DO NOT** uninstall the driver and application.

Intel® Optane™ Memory & Storage Management

Run **Intel® Optane™ Memory & Storage Management** from the Start menu in Windows (click **All apps** and scroll down to **Intel® Optane™ Memory & Storage Management**).

Figure 6 - 25
**Intel® Optane™
Memory & Storage
Management**

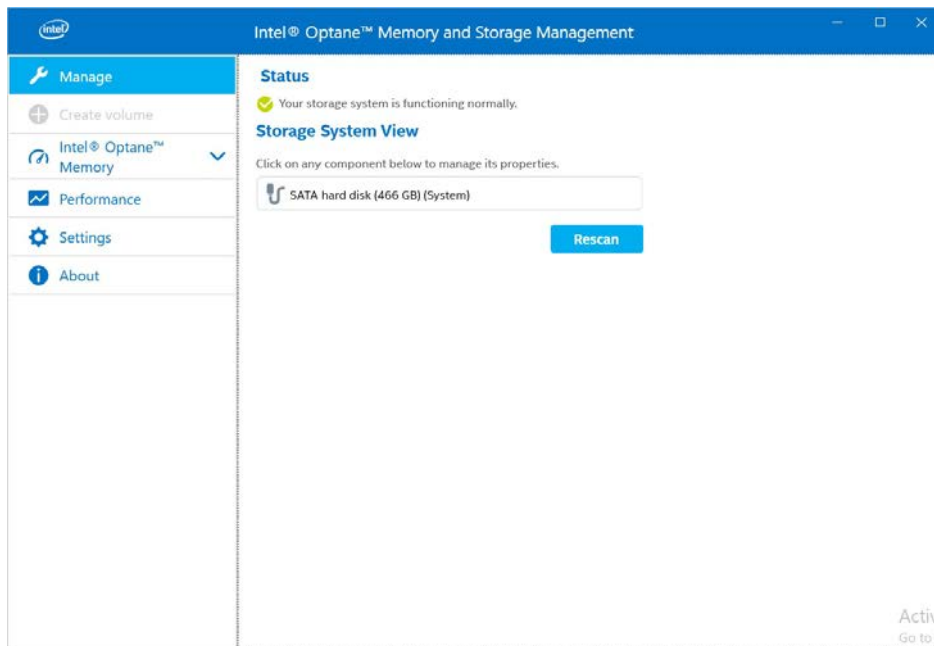

Intel® Optane™ Memory & Storage Management for RAID Systems

The Intel® Optane™ Memory & Storage Management application also displays status information on your RAID configuration. Run the Intel® Optane™ Memory & Storage Management from the Start menu in Windows.

When the application is launched the system will open the **Manage** window where you can view the general health of the storage system. Various volume creation and management options are available depending on the system’s status.

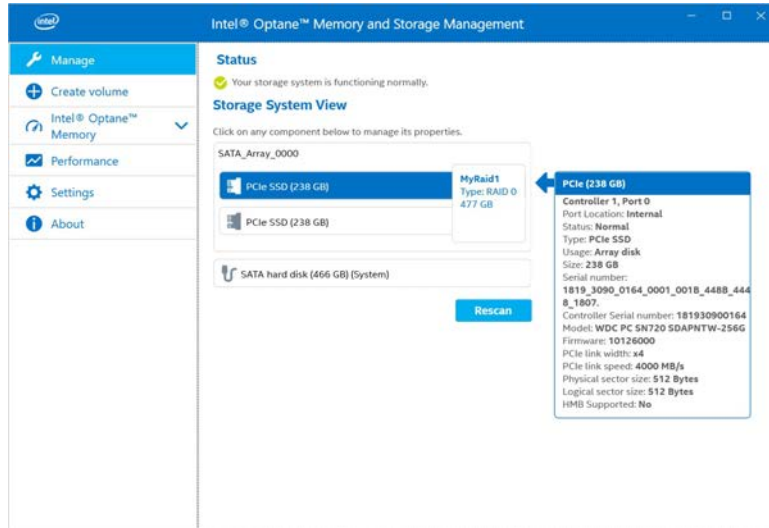



Deleting & Creating RAID Volumes

Note that The Intel® Optane™ Memory & Storage Management application offers limited options to manage your RAID system.

If you want to delete or create RAID volumes you should use the BIOS settings to do so (see [“Create RAID Volume” on page 6 - 5](#)).

Figure 6 - 26
**Intel® Optane™
 Memory & Storage
 Management
 RAID Status**

Intel® Optane™ Memory & Storage Management Help & Support

Click the link in *For help and support ...* in the **About** menu to go to the Intel support page.

The screenshot shows the Intel Optane Memory & Storage Management application interface. The top bar is blue with the Intel logo and the text "Intel® Optane™ Memory and Storage Management". On the left, there is a vertical menu with the following items: "Manage" (wrench icon), "Create volume" (plus icon), "Intel® Optane™ Memory" (refresh icon), "Performance" (line graph icon), "Settings" (gear icon), and "About" (info icon). The "About" item is highlighted in blue. On the right, the main content area is titled "Intel® Optane™ Memory and Storage Management" and contains the following text: "Product Version : 17.8.1007.0", "Driver Version : 17.8.0.1065", "Copyright © 2018-2019", and "For help and support visit: <http://intel.com/support/optane-memory>". The link is circled in green. Below this is the "Additional components" section, which lists: "NLog for .NET Framework 4.5 4.5.10", "Copyright (c) 2004-2018 NLog Project - <http://nlog-project.org/>", "BSD 3-clause 'New' or 'Revised' License [view full text](#)", "Autofac 4.8.1", "Copyright © 2015 Autofac Contributors", "MIT License [view full text](#)", "Json.NET 11.0.2", "Copyright © James Newton-King 2008", and "MIT License [view full text](#)".

Figure 6 - 27
Intel® Optane™
Memory & Storage
Management
Help

Intel® Optane™ Memory & Storage Management Performance

Enable/Disable Link Power Management link management from the Performance menu. When enabled it allows the SATA host bus adapter to enter a low-power state when there is no I/O activity to save energy.

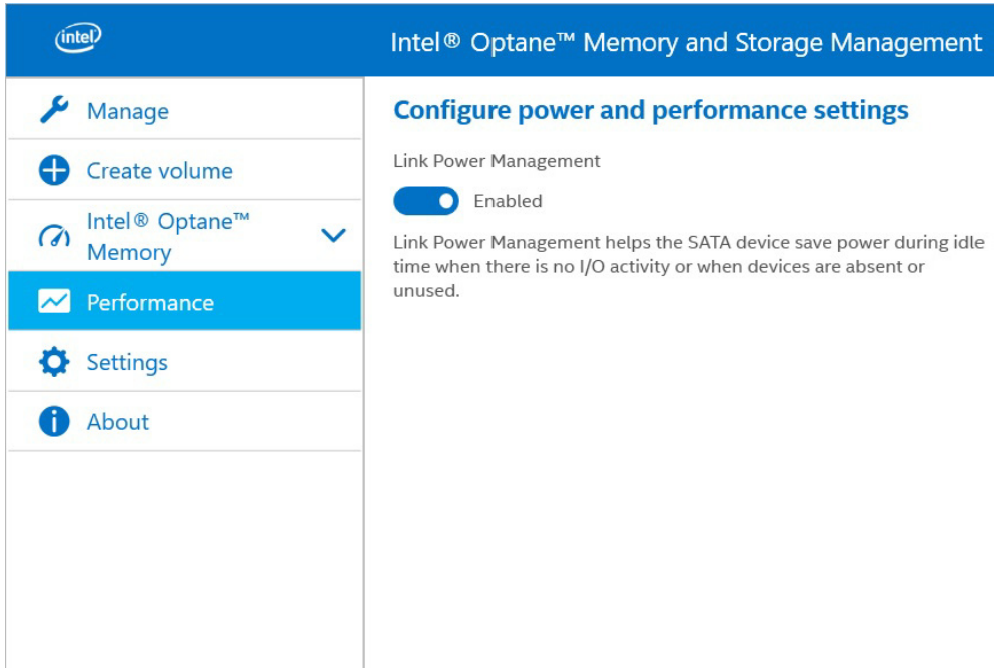
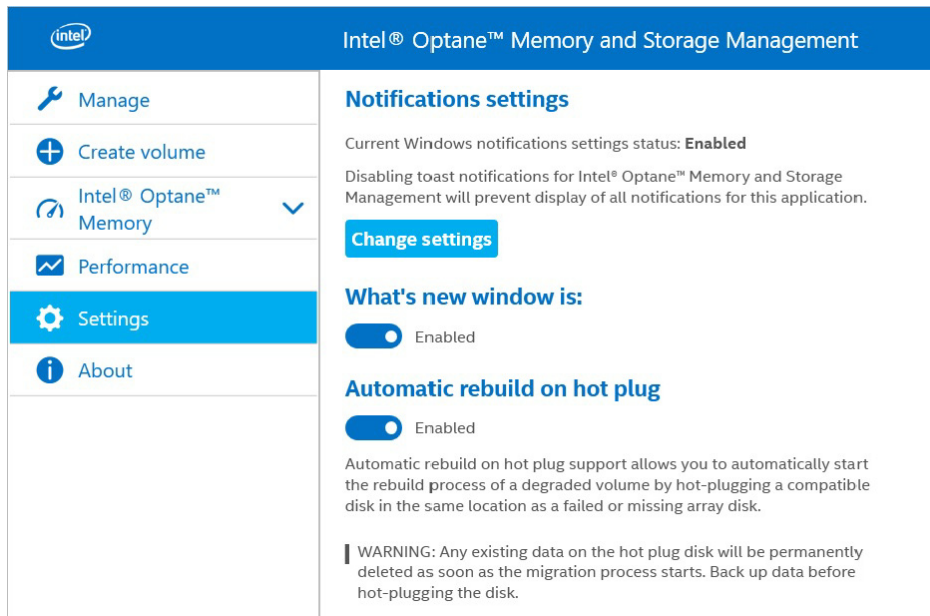

Figure 6 - 28
**Intel® Optane™
 Memory & Storage
 Management
 Performance**

Intel® Optane™ Memory & Storage Management Settings

Enable **Automatic rebuild on hot plug** to automatically start rebuilding any degraded volume by simply hot plugging a compatible disk into the same location as any failed or missing drive. Do bear in mind the warranty terms as outlined in the sidebar, and you should contact your distributor or supplier for help in the case of degraded volumes or drives.

Figure 6 - 29
Intel® Optane™
Memory & Storage
Management
Settings



Intel® Optane™ Memory and Storage Management

Manage

Create volume

Intel® Optane™ Memory

Performance

Settings

About

Notifications settings

Current Windows notifications settings status: **Enabled**

Disabling toast notifications for Intel® Optane™ Memory and Storage Management will prevent display of all notifications for this application.

[Change settings](#)

What's new window is:

Enabled

Automatic rebuild on hot plug

Enabled

Automatic rebuild on hot plug support allows you to automatically start the rebuild process of a degraded volume by hot-plugging a compatible disk in the same location as a failed or missing array disk.

WARNING: Any existing data on the hot plug disk will be permanently deleted as soon as the migration process starts. Back up data before hot-plugging the disk.

Creative Sound Blaster Studio Pro 2 Audio

Install the **Creative App** to allow you to configure the audio settings to your requirements for the best performance in games, music and movies.

Creative Sound Blaster Studio Pro 2 Installation

1. Insert the *Device Drivers & Utilities + User's Manual* disc an attached DVD drive.
2. Click **Install Drivers** (button).
3. Click **11.Install Creative Driver > Yes**.
4. Select the installation language and click **OK**.
5. Click to accept the terms of the license agreement and then click **Next**.
6. Click **Next > Install**.
7. Click **Finish**.
8. Click **OK** and the system will automatically restart to complete the driver installation process.
9. The **Creative App** will download but you will need to have a working internet connection.
10. Click the **Start** menu in Windows to access the **Microsoft Store** app tile under **Explore**.
11. Click the **Sign in** icon  and select **Library**.
12. Click **Get Updates** and a list of apps being downloaded will pop-up.
13. When installed the **Creative App** will appear in the **Windows Start** menu.

Creative Sound Blaster Studio Pro 2 Audio App

1. Click **Browse CD/DVD** (button) from *Device Drivers & Utilities + User's Manual disc* and navigate to *Options//PreInstallKit/04_Creative* and double-click **SBStudioProInstallerSetup_XXXXX**.
2. Click **Install > Finish**.
3. Then click **Browse CD/DVD** (button) from *Device Drivers & Utilities + User's Manual disc* and navigate to *Options//PreInstallKit/04_Creative* and double-click **CreativeAppSetup_XXXXX**.
4. Select the installation language and click **OK**.
5. Click to accept the terms of the license agreement and then click **Next**.
6. Click **Next > Next > Install**.
7. Click **Finish** to restart the computer to complete the installation.

Creative Application

Run the **Creative App** from the Start menu in Windows (click **All apps** and scroll down to **Creative App**).

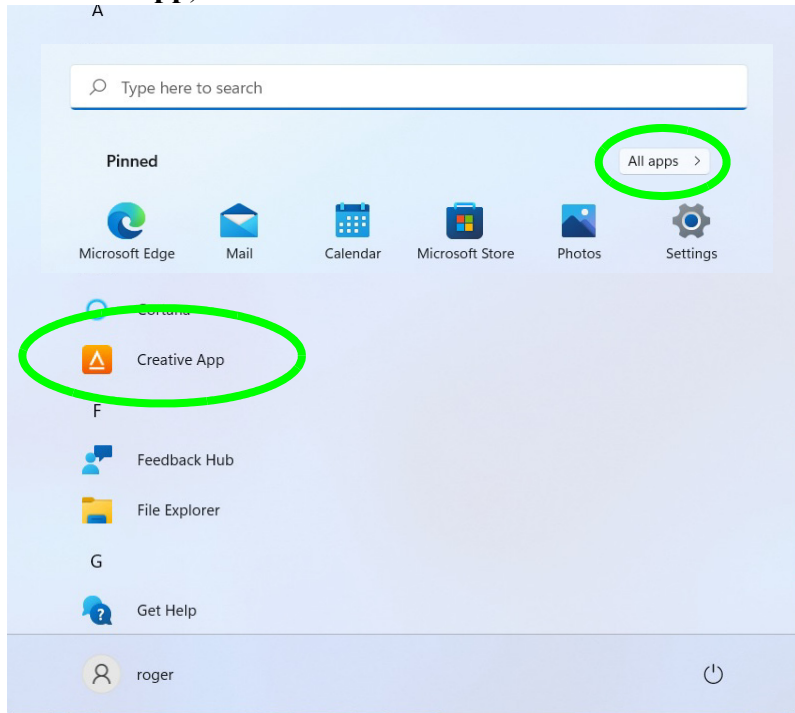

Figure 6 - 30
Creative App
(Windows Start
Menu)

Device

The **Device** menu contains a number of audio control panels. The drop down menu under Sound Mode has different presets for **Gaming**, **Movie**, **Music** etc. Click the output icon  at the bottom left of the screen to select **Headphones** or **Speakers**. It is recommended you click **Sign In** and create a Creative account. **Click Edit to add or remove control panels**

Figure 6 - 31
Creative App -
Device



Sound Mode

Sound Mode allows you to view, and change, the settings for a number of modules, and you can save a Sound Mode profile to apply the settings across modules.

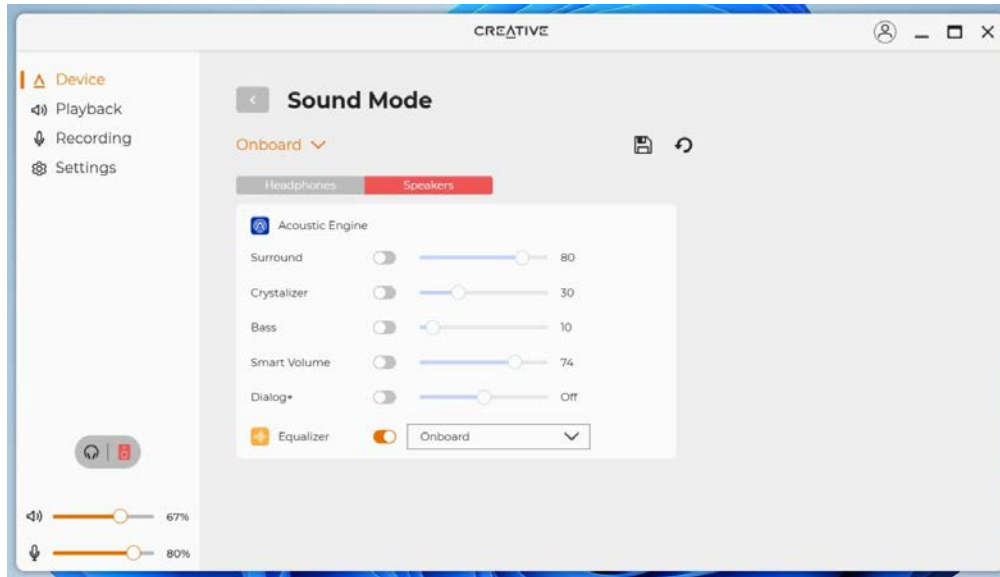

Figure 6 - 32
Sound Mode

Acoustic Engine

The **Acoustic Engine** offers a suite of playback technologies to enhance sound. Each playback technology has an **On/Off button** to allow you to enable/disable it, and most controls feature a dial to adjust the levels.



Figure 6 - 33
Acoustic Engine

- **Surround:** Provides virtual sound channels to control the level of immersion.
- **Crystalizer:** Enriches audio to make it sound livelier.
- **Bass:** Enhances the bass level of the sound system.
- **Smart Volume:** Minimizes sudden volume changes to avoid the need for constant adjustment.
- **Dialog Plus:** Optimizes dialogue levels for music and movies etc.

Equalizer

The **Equalizer** allows you to manually adjust the **Custom** settings (click **On** to enable the Equalizer).

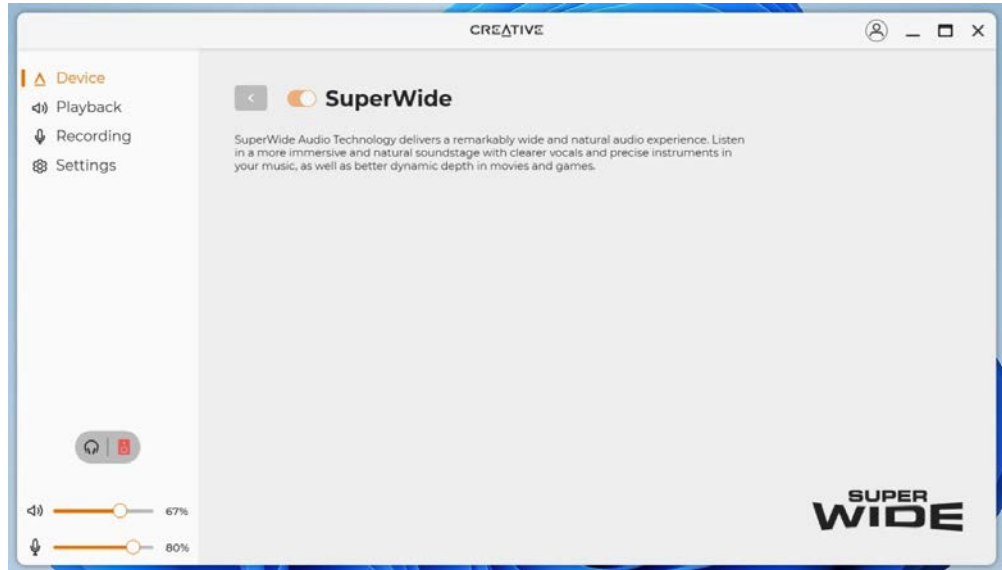

Figure 6 - 34
Equalizer

SuperWide

SuperWide is available when **Built-In speakers** are the selected output. SuperWide provides a wide and immersive audio experience.

Figure 6 - 35
SuperWide



SoundFit

SoundFit is a feature designed to optimize your headphone output. Plug-in your headphones or headset and follow the on-screen instructions to set up a profile to your preferences.

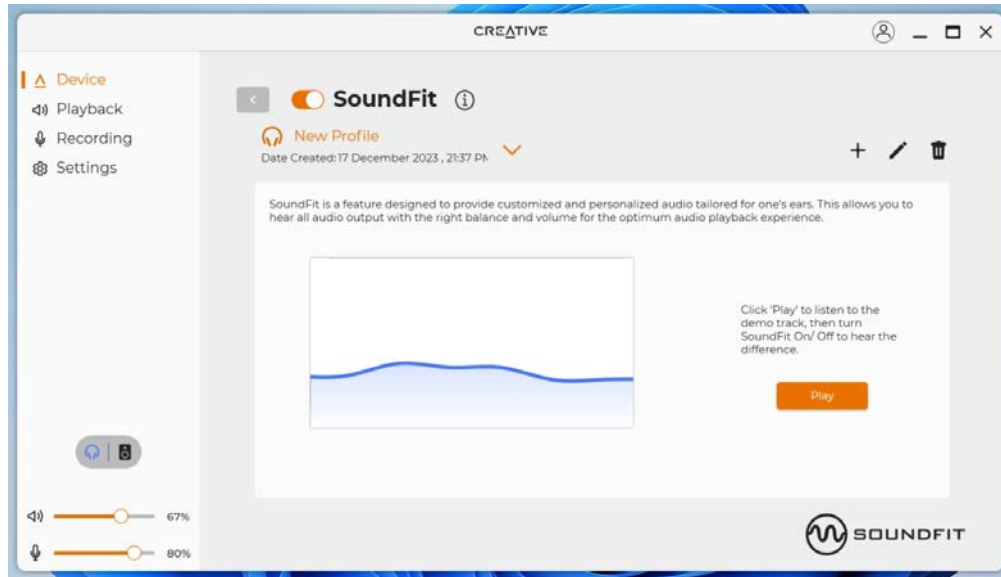
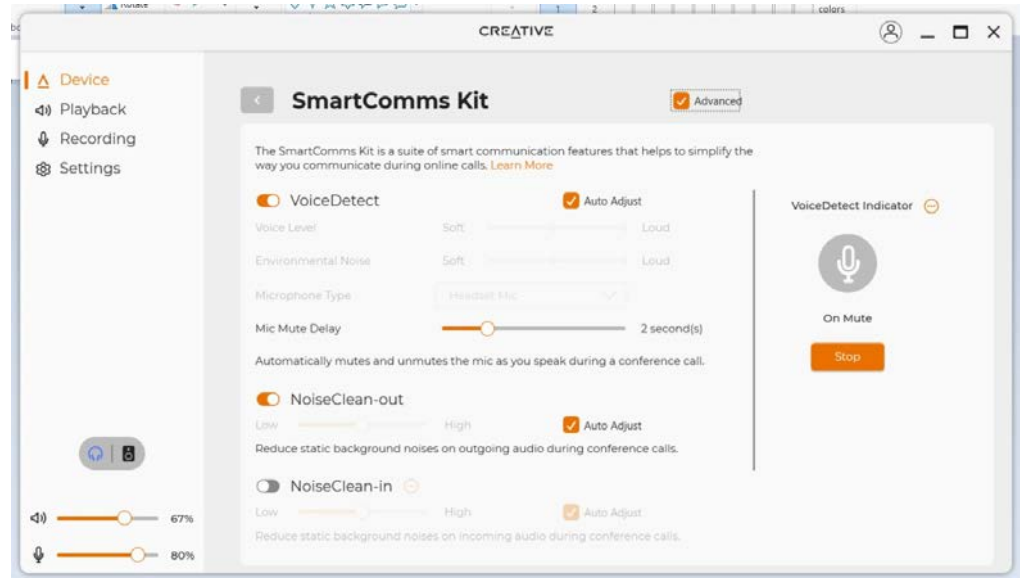

Figure 6 - 36
SoundFit

SmartComms Kit

Smart Comms Kit is designed to help with settings for online calls and features **VoiceDetect**, **NoiseClean-Out** and **Noise Clean-In** to auto mute the mic, and cancel noise in two way online conversations. Click to turn **On**, and select **Advanced** to see all the sliders and options (click **Learn More** to get help).

Figure 6 - 37
SmartComms Kit



Crystal Voice

Adjust the microphone settings from these recording controls under the **Crystal Voice** menu. The profiles in **Voice Morph** allow you to alter your voice in gaming or online chats.

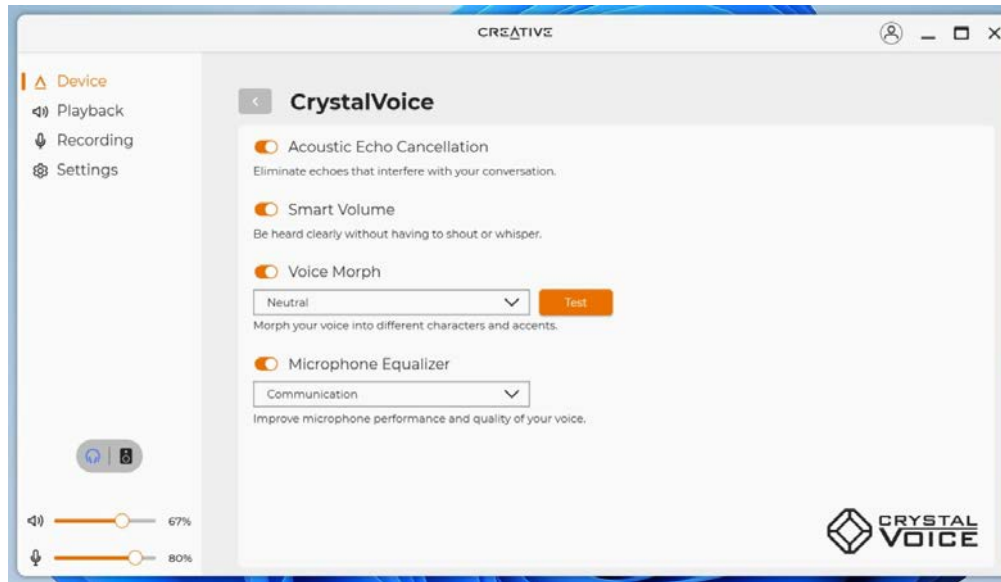
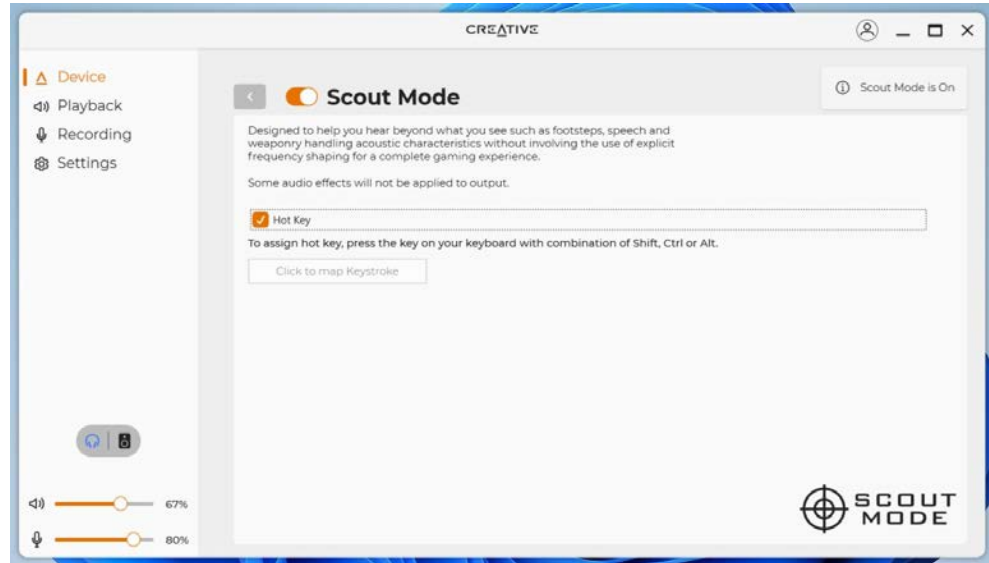

Figure 6 - 38
Crystal Voice

Scout Mode

Click on the power button to enable **Scout Mode/Radar** to enhance your ability to hear enemies in games from a further distance away than would normally be possible.

Figure 6 - 39
Scout Mode



Mixer

The **Mixer** allows you to adjust the volume levels for **Playback** and **Recording**.

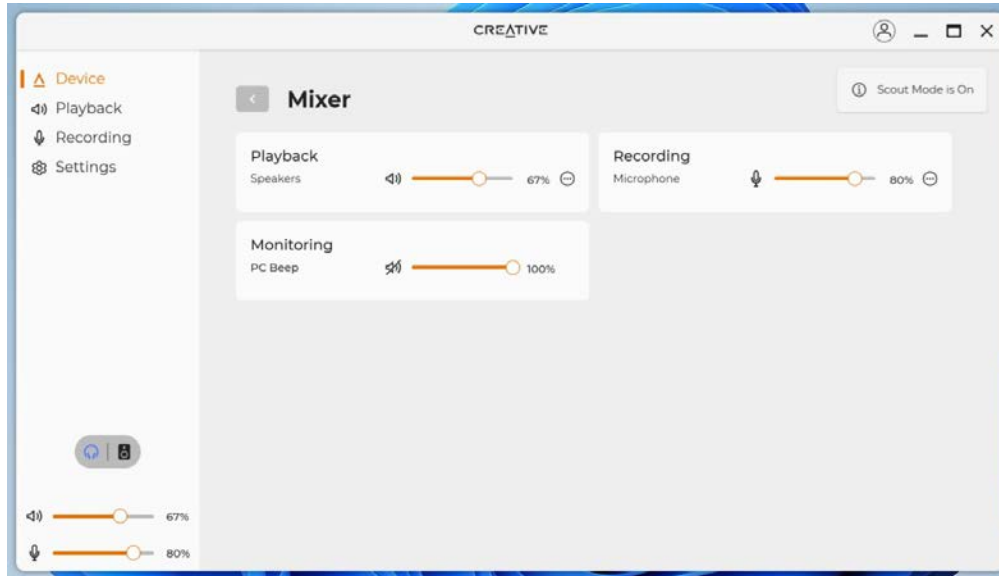
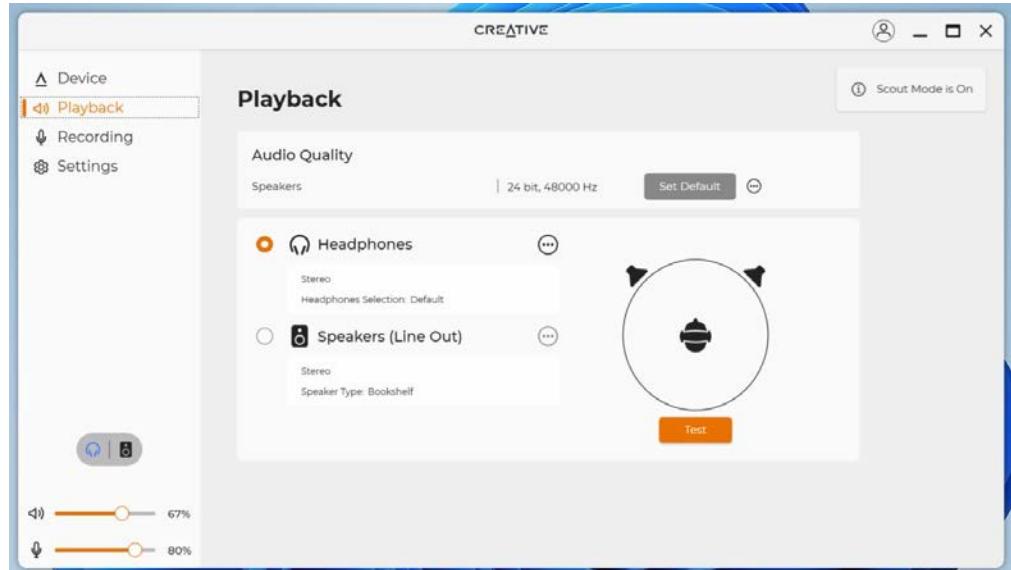

Figure 6 - 40
Mixer

Playback

Playback can be used to **Test** the configuration of the headphones and speakers.

Figure 6 - 41
Playback



Recording

Recording can be used to configure any attached recording sources.

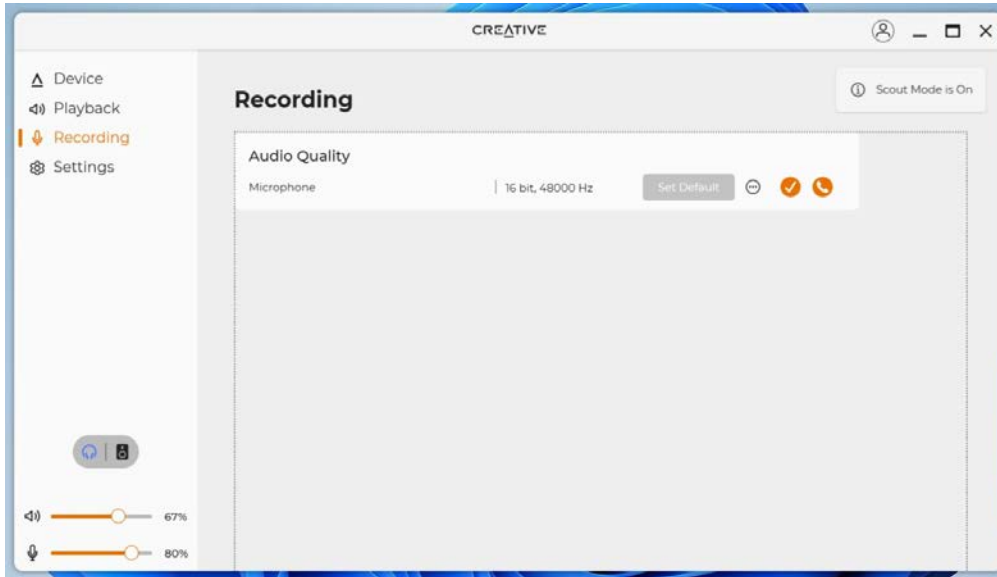
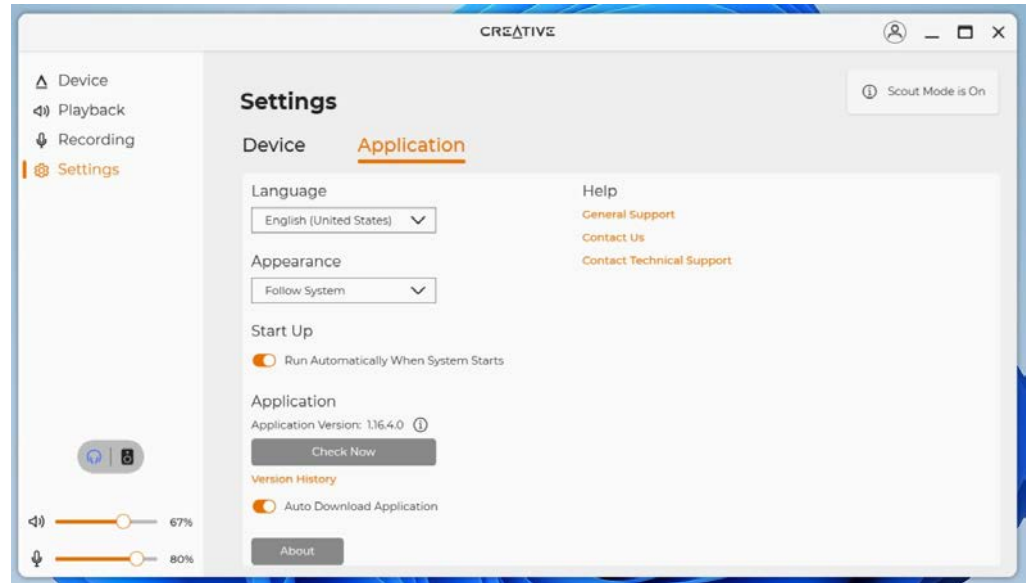

Figure 6 - 42
Recording

Settings

Settings allows you to set the language preferences. Click **Reset** to return all configurations to the factory default settings.

Figure 6 - 43
Settings



Trusted Platform Module

(Optional)

The **TPM security chip** allows you to create and manage digital certificates for user and platform authentication. This type of security is usually administered within large enterprises and organizations, and therefore requires implementation by a system administrator before users can access security features.

Individual users can use the TPM as an authentication with the fingerprint reader.

Make sure you have administrator's rights to your computer, and have a *Windows* password enabled for full security protection. In addition **Make sure you prepare a removable media (e.g. a USB flash drive) to store passwords etc. before beginning the TPM initialization process.**

Before setting up the TPM functions you must initialize the security platform.



Clearing TPM Information

You can click **Clear TPM**, which will toggle the setting between **Enabled/Disabled**. If set to **Enabled** this will clear existing TPM information in order to re-set the TPM.

Enabling & Activating TPM

1. Restart the computer.
2. Enter the **BIOS** pressing **F2** during the POST/startup.
3. Click to enter the **Setup Utility** and select the **Security** menu.
4. Click **TPM Configuration** and select **Enabled** for **Clear TPM**.
5. You will then need to save the changes and restart the computer.



Figure 6 - 44
Security - Trusted Computing

TPM Management in Windows

You can manage your TPM settings from within *Windows*:

1. Go to the **Control Panel**.
2. Click **BitLocker Drive Encryption (System and Security)**.
3. Click **TPM Administration**.

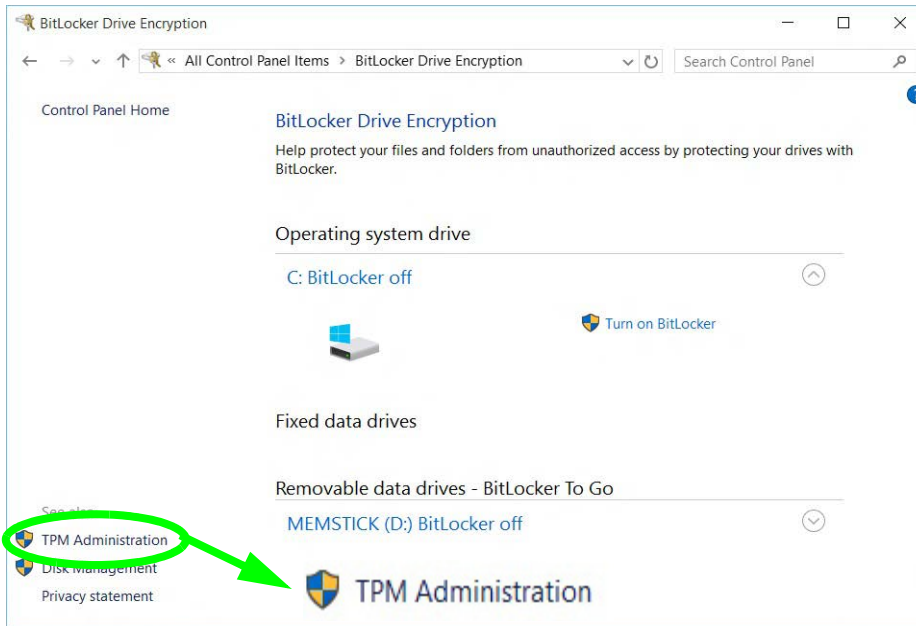
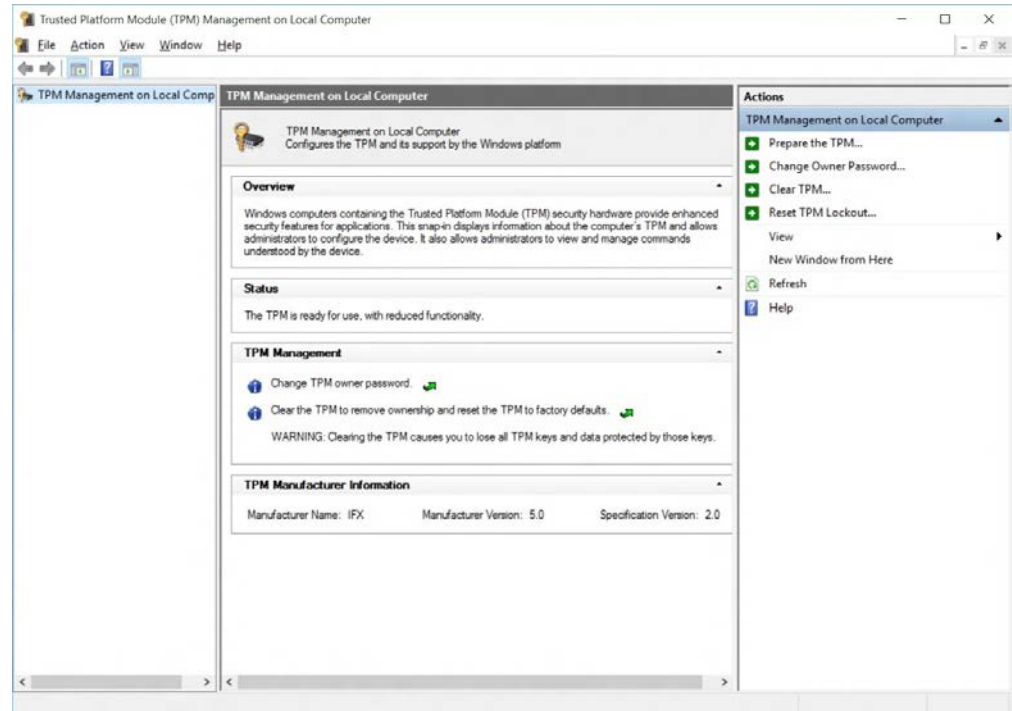

Figure 6 - 45
BitLocker Drive Encryption (TPM Administration)

- The TPM Management window allows you to configure the TPM within **Windows**. As TPM is usually administered within large enterprises and organizations, your system administrator will need to assist you in managing the information here.



6

Figure 6 - 46
**Trusted Platform
Module (TPM)
Management on
Local Computer
Administration**

TPM Actions

1. Click **Prepare the TPM** and follow the instructions in the Wizard **to** prepare the TPM (this will probably require a restart of the computer and confirmation of the setting changes after restart by pressing the appropriate F key).
2. After the restart the TPM will be prepared and you can then use the **Actions** menu to **Turn TPM off**, **Change Owner Password**, **Clear TPM** or **Reset TPM Lockout**.
3. A wizard will help take you through any setup steps.

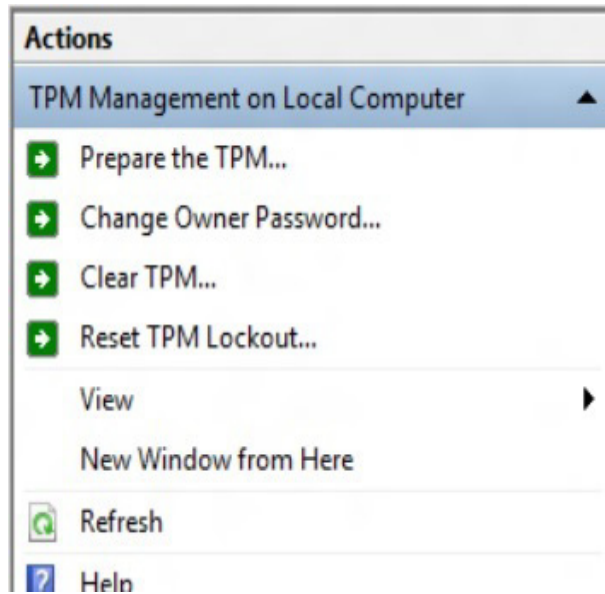

Figure 6 - 47
TPM Actions Menu

BitLocker

BitLocker Drive Encryption can be used in conjunction with the TPM to encrypt data on the disk. Access the Microsoft **BitLocker Drive Encryption** control panel applet from the *Windows* control panel (**System and Security**).

1. Click **Turn on Bit Locker**.
2. Follow the on-screen instructions to setup BitLocker, and make sure you have a removable media (e.g. a USB flash drive) to store saved recovery keys etc.

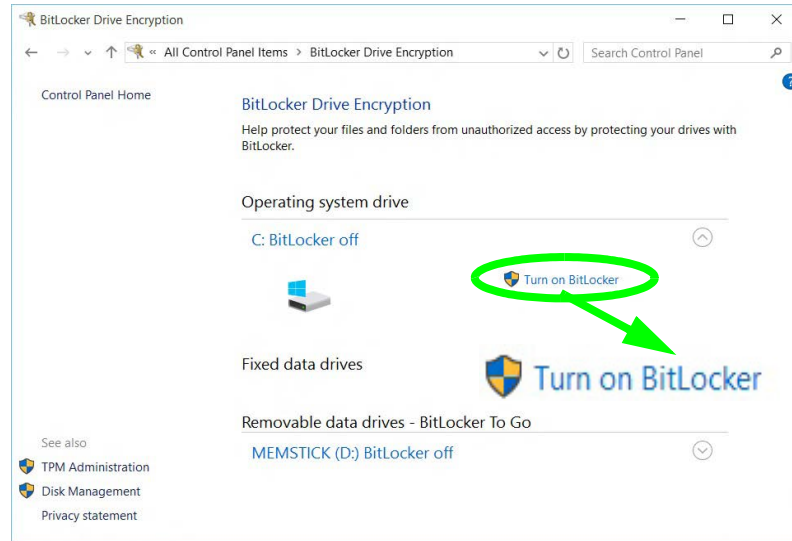

Figure 6 - 48
BitLocker Drive Encryption

Chapter 7: Troubleshooting

Overview

Should you have any problems with your computer, before consulting your service representative, you may want to try to solve the problem yourself. This chapter lists some common problems and their possible solutions. This can't anticipate every problem, but you should check here before you panic. If you don't find the answer in these pages, make sure you have followed the instructions carefully and observed the safety precautions in the preface. If all else fails, talk to your service representative. You should also make a record of what happened and what remedies you tried.

Of course, if something goes wrong, it will happen at the most inconvenient time possible, so you should preview this section just in case. If, after you've tried everything, and the system still won't cooperate, try turning it off for a few minutes and then rebooting. You will lose any unsaved data, but it may start working again. Then call your service representative.

Basic Hints and Tips

Many of the following may seem obvious but they are often the solution to a problem when your computer appears not to be working.

- **Power** - Is the computer actually plugged into a working electrical outlet? If plugged into a **power strip**, make sure it is actually working. Check the **LED Power & Communication Indicators** (see *“LED Indicators” on page 1 - 9*) to see the computer’s power status.
- **Connections** - Check all the **cables** to make sure that there are no **loose connections** anywhere.
- **Power Savings** - Make sure that the system is not in **Hibernate** or **Sleep** mode by pressing the keys configured in your *Power Options* (see *“Power-Saving States” on page 3 - 13*), the **Fn + F12** key combination, or power button to wake-up the system.
- **Brightness** - Check the brightness of the screen by pressing the **Fn + F8 and F9** keys to adjust the brightness.
- **Display Choice** - Press **Fn + F7** to make sure the system is not set to “external only” display.
- **Boot Drive** - Make sure there are no **optical media and/or USB storage devices** in any connected drive.

Backup and General Maintenance

- Always **backup** your important data, and keep copies of your OS and programs safe, but close to hand. Don't forget to note the **serial numbers** if you are storing them out of their original cases, e.g. in a CD wallet.
- Run **maintenance programs** on your hard disk and OS as often as you can. You may schedule these programs to run at times when you are not using your computer. You can use those that are provided free with your OS, or buy the more powerful dedicated programs to do so.
- Write down your passwords and keep them safe (away from your computer). This is especially important if you choose to use a **Supervisor** password for the BIOS (see *“The Insyde BIOS Utility” on page 5 - 2*).
- Keep copies of vital **settings files** such as network, dialup settings, mail settings etc.(even if just brief notes).



Warranty

The CPU is not a user serviceable part. Opening this compartment, or accessing the CPU in any way, may violate your warranty.

Viruses

- Install an **Anti-Virus** program and keep the **definitions file** (the file which tells your program which viruses to look for) up to date. New computer viruses are discovered daily, and some of them may seriously harm your computer and cause you to lose data. **Anti-Virus** programs are commercially available and the **definitions file updates** are usually downloadable directly from the internet.
- Be careful when opening e-mail from sources you don't know. **Viruses** are often triggered from within **e-mail attachments** so take care when opening any attached file. You can configure most **Anti-Virus** programs to check all **e-mail attachments**. **Note:** You should also beware of files from people you know as the virus may have infected an **address book** and been automatically forwarded without the person's knowledge.
- Keep a "**Bootable CD-ROM/DVD-ROM/USB storage device**" (this CD/DVD/USB device provides basic information which allows you to startup your computer) handy. You may refer to your OS's documentation for instructions on how to make one, and many **Anti-Virus** programs will also provide such a disk (or at least instructions on how to make one).

Upgrading and Adding New Hardware/Software

- Do not be tempted to make changes to your **Windows Registry** unless you are very sure of what you are doing, otherwise you will risk severely damaging your system.
- Don't open your computer or undertake any repair or upgrade work if you are not comfortable with what you are doing.
- Read the **documentation**. We can assume, since you are reading this that you are looking at the computer's manual, but what about any new peripheral devices you have just purchased? Many problems are caused by the installation of new hardware and/or software. Always refer to the documentation of any new hardware and/or software, and pay particular attention to files entitled "**READ ME**" or "**READ ME FIRST**".
- When installing a new device always make sure the device is powered on, and in many cases you will need to restart the computer. Always check that all the cables are correctly connected.
- Make sure you have installed the **drivers** for any new hardware you have installed (latest **driver files** are usually available to download from vendor's websites).

Troubleshooting

- Thoroughly check any **recent changes** you made to your system as these changes may affect one or more system components, or software programs. If possible, go back and undo the change you just made and see if the problem still occurs.
- Don't over complicate things. The less you have to deal with then the easier the source of the problem may be found; **Example** - if your computer has many devices plugged into its ports, and a number of programs running, then it will be difficult to determine the cause of a problem. Try disconnecting all of the devices and restarting the computer with all the peripheral devices unplugged. A process of elimination (adding and removing devices and restarting where necessary) will often find the source of a problem, although this may be time consuming.

Problems and Possible Solutions

Problem	Possible Cause - Solution
The battery LED power indicator  , is blinking orange.	<i>Low Battery.</i> Plug in the DC power source. If the computer doesn't start up immediately, turn it off then on again.
You are losing battery power too quickly.	<i>The system is using too much power.</i> If your OS has a <i>Power Options</i> scheme (see "Power Plans" on page 3 - 11) check its settings. You may also be using a <i>peripheral device/USB device</i> that is drawing a lot of power.
Actual battery operating time is shorter than expected.	<p><i>The battery has not been fully discharged before being recharged.</i> Make sure the battery is fully discharged and recharge it completely before reusing (see pages 3 - 22 to 3 - 26).</p> <p><i>Power Options have been disabled.</i> Go to the Control Panel in <i>Windows</i> and re-enable the options.</p> <p><i>A peripheral device/USB device is consuming a lot of power.</i> Turn off/remove the unused device to save power.</p>
The computer feels too hot .	<p>Make sure the computer is properly ventilated and the Vent/Fan intakes are not blocked. If this doesn't cool it down, put the system into Hibernate mode or turn it off for an hour. Make sure the computer isn't sitting on a thermal surface (see "Overheating" on page 1 - 15). Make sure you're using the correct adapter.</p> <p>Make sure that your notebook is completely powered off before putting it into a travel bag (or any such container). Putting a notebook which is powered on in a travel bag may cause the Vent/Fan intakes to be blocked.</p>

Troubleshooting

Problem	Possible Cause - Solution
The system will not start up when it is being operated in a low temperature environment .	This is due to the electrical characteristics of battery cells at low temperatures. Although the lowest operational temperature tolerance of the system is listed at 5°C, however if the system is in DC mode (on battery), the battery must have a remaining charge capacity of 60%+; at 10°C or above.
The system never goes into a power saving mode .	Power Options features are not enabled. Go to the Windows Power Options menu and enable the features you prefer (see “Power-Saving States” on page 3 - 13). Make sure you have enabled Hibernate mode from the control panel.
<div data-bbox="113 524 1477 734" style="border: 2px solid red; border-radius: 20px; padding: 10px; text-align: center;"> DC-In Jack It's essential to fully plug an AC/DC adapter into the jack on the right side of the computer to ensure a secure connection and prevent issues like poor charging or an electrical short circuit (see “Power Safety” on page I - X of the Preface).</div>	

Problem	Possible Cause - Solution
<p>Nothing appears on screen.</p>	<p><i>The system is in a power saving mode.</i> Toggle the sleep/resume key combination, Fn + F4 (see “Configuring the Power Buttons” on page 3 - 15).</p> <p><i>The screen controls need to be adjusted.</i> Toggle the screen control key combinations Fn + F8/F9. If you’re connected to an external monitor, make sure it’s plugged in and turned on. You should also check the monitor’s own brightness and contrast controls.</p> <p><i>The computer is set for a different display.</i> Toggle the screen display key combination, Fn + F7. If an external monitor is connected, turn it on.</p> <p><i>The screen saver is activated.</i> Press any key or touch the TouchPad.</p>
<p>No image appears on the external monitor I have plugged in and powered on.</p>	<p><i>You haven’t installed the video driver and configured it appropriately from the Control Panel.</i> See Appendix B for instructions on installing and configuring the video driver.</p>
<p>Unwelcome numbers appear when typing.</p>	<p><i>Num Lock is turned ON</i> (see “LED Indicators” on page 1 - 9).</p>
<p>When playing a video in Media Player, while using a 4K panel, the counting timer area at the bottom of the screen appears to be cut off slightly.</p>	<p><i>The size of text, apps and other items in Settings > System > Display is set to 250%.</i> In this case it is recommended that the setting should be less than 250%.</p>

Troubleshooting

Problem	Possible Cause - Solution
When you are playing a game and you use the Windows Key to switch to the desktop an error message, or Blue Screen, occurs.	<i>This is a DirectX compatibility issue. In this case disable DirectX from within the game controls.</i>
You forget the boot password.	<i>If you forget the password, you may have to discharge the battery of the CMOS. Contact your service representative for help.</i>
 <p>Password Warning</p> <p>If you choose to set a boot password, NEVER forget your password. The consequences of this could be serious. If you cannot remember your boot password you must contact your vendor and you may lose all of the information on your hard disk.</p>	
The sound cannot be heard or the volume is very low.	<i>The volume might be set too low. Check the volume control in the Volume Control Panel in the Windows notification area, or use the key combination Fn + F5 and F6 (see “Function/Hot Key Indicators” on page 1 - 13) to adjust.</i>
My internal microphone seems to be disabled and/or I can still hear sound from the speakers even though I have plugged headphones into the headphone jack.	<i>“Enable jack detection when device is plugged in” is disabled in Connector Settings (Device advanced settings) in the Realtek Audio Console control panel. Go to the Realtek Audio Console control panel and click Device advanced settings and make sure that “Enable jack detection when device is plugged in” is On.</i>

Problem	Possible Cause - Solution
There is no sound from the Microphone .	<i>The microphone volume is toggled off or is too low.</i> Check the microphone setting in Settings > System > Input in Windows, or use the key combination Fn + 4 (see <i>“Function/Hot Key Indicators” on page 1 - 13</i>) to toggle the microphone on/off.
I am sliding my finger up and down on the right side of the Touchpad to scroll a Window and the Touchpad does not respond .	<i>There are different Touchpad versions available on this computer, and this version requires tapping/holding to scroll.</i> Either tap repeatedly, or hold the finger down, at the top or bottom right of the Touchpad (depending on the scrolling direction required) to scroll the window.
 <h3>Other Keyboards</h3> <p>If your keyboard is damaged or you just want to make a change, you can use any standard USB keyboard. The system will detect and enable it automatically. However special functions/hot keys unique to the system's regular keyboard may not work.</p>	
The system freezes or the screen goes dark.	<i>The system's power saving features have timed-out.</i> Use the AC/DC adapter, press the sleep (Fn + F4) key combination, or press the power button if no LEDs are lit.
The screen appears to be upside down .	<i>The screen rotation feature has been enabled.</i> Use screen rotation (Fn + R) key combination to rotate the screen again.

Troubleshooting

Problem	Possible Cause - Solution
<p>The computer is off (or in Sleep Mode) but powered by the AC/DC adapter plugged in to a working outlet, or by battery with a capacity above 20%. I have plugged a device into the powered USB port in order to charge it, but the device is not charging.</p>	<p><i>The port is not powered on.</i> Toggle power to the port using the Fn + power button combination.</p> <p><i>This function may not work with certain external USB compliant devices (check your device's documentation).</i> If this is the case, power the computer on and connect the external USB device in order to charge it.</p> <p>Note that this function is designed to help charge USB compliant devices, but is not designed to allow their operation.</p>

7



Powered USB Port

Note that the powered USB 3.2 Gen 2 port (Type A) is not operational under DOS and does not support wake on USB. The **powered USB 3.2 (4)** in *Figure 1 - 5 on page 1 - 15* port can supply power (**for charging devices only, not for operating devices**) when the system is off but still powered by the AC/DC adapter plugged into a working outlet, or powered by the battery with a capacity level above 20% (this may not work with certain devices). Toggle power to this port by using **Fn + power button**.

Problem	Possible Cause - Solution
<p>I am trying to uninstall a driver (e.g. the Intel Graphics driver) but it does not appear in the Programs and Features control panel in Windows.</p>	<p><i>If this is the case, the driver will need to be removed from the Device Manager. Not all driver installation processes create an entry in Add or Remove Programs. If it does not appear in the Programs and Features Control Panel, go to Device Manager, select the hardware item (you may need to click on it to expand the sub-menu), right-click the driver name, and select uninstall device > Uninstall. Follow the on-screen instructions and then re-install the driver as required.</i></p>
<p>Gaming performance is slow.</p>	<p><i>It is recommended that you use Maximum fan speed when playing games. Use the Fn + 1 key combination to adjust the fan speed.</i></p>
<p>The Wireless LAN/Bluetooth modules cannot be detected.</p>	<p><i>The modules are off as the computer is in Airplane Mode. Go to the Charms Bar and select Settings and then click the WiFi icon (Airplane mode should be Off).</i></p>
<p>The Webcam module cannot be detected.</p>	<p><i>The module is off. Press the Fn + F10 key combination in order to enable the module (see “Function/Hot Key Indicators” on page 1 - 13). Run the camera application to view the camera picture.</i></p>
<p>The Wireless LAN/Bluetooth modules cannot be configured.</p>	<p><i>The driver(s) for the module(s) have not been installed. Make sure you have installed the driver for the appropriate module (see the instructions for the appropriate module in “Modules & Options” on page 6 - 1).</i></p>

Troubleshooting

Problem	Possible Cause - Solution
A file cannot be copied to/from a connected Bluetooth device.	<i>The transfer of data between the computer and a Bluetooth enabled device is supported in one direction only (simultaneous data transfer is not supported). If you are copying a file from your computer to a Bluetooth enabled device, you will not be able to copy a file from the Bluetooth enabled device to your computer until the file transfer process has been completed</i>
When using a Bluetooth headset the audio appears to be mono and not stereo.	<i>This is a common issue with Bluetooth headsets. To resolve this issue do the following (you will need to repeat this procedure after every boot up, restart, or when the system resumes from hibernation):</i> <ol style="list-style-type: none">1. Go to the Devices & Printers control panel in Windows.2. Double-click the Bluetooth headset.3. Click Connect to complete the stereo connection. OR <ol style="list-style-type: none">1. Go to the Sound control panel in Windows.2. Right-click (in the Playback tab) the Bluetooth Stereo Audio device (the default device is Headset).3. Click Connect to complete the stereo connection.





Problem	Possible Cause - Solution
<p>A file being copied to/from a connected Bluetooth device appears to be transferring very slowly.</p>	<p>You may have the Bluetooth control panel (<i>Bluetooth & devices</i>) open. When transferring data between the computer and a Bluetooth enabled device, make sure that the Bluetooth control panel is closed.</p> 



Appendix A: Interface (Ports & Jacks)

Overview

The following chapter will give a quick description of the interface (ports & jacks) which allow your computer to communicate with external devices, connect to the internet etc.

Notebook Ports & Jacks

Item	Description
<p>2-In-1 Audio Jacks Headphone/ Microphone</p> 	<p>Headphone / Microphone Headphones, headsets, microphones or speakers may be connected through this jack. Note: Set your system's volume to a reduced level before connecting to this jack. Plug an external headset in to this jack to record, or use a communication device, on your computer.</p>
<p>DC-In Jack</p> 	<p>Plug the supplied AC/DC adapter into this jack to power your computer.</p>
<p>HDMI-Out Port</p> 	<p>The HDMI-Out (High-Definition Multimedia Interface) is an audio/video connector interface for transmitting uncompressed digital streams. This allows you to connect an external monitor, TV or Flat Panel Display etc. as a display device by means of a HDMI cable. Note that HDMI carries both audio and video signals.</p>
<p>RJ-45 LAN Jack</p> 	<p>This port supports LAN (Network) functions (you will need to open the cover slightly before inserting a LAN cable). Note: Broadband (e.g. ADSL) modems usually connect to the LAN port.</p>
<p>Security Lock Slot</p> 	<p>To prevent possible theft, a Kensington-type lock can be attached to this slot. Locks can be purchased at any computer store.</p>

Item	Description
<p>Thunderbolt 5 Ports</p>  <p>(including 1 Thunderbolt 5 Port with Power Delivery DC-In)</p>	<p>The Thunderbolt 5 ports allow for the connection of external peripherals to the computer by combining PCI Express (PCIe), DisplayPort (DP), USB and its own Thunderbolt 5 technologies. A Thunderbolt 5 port can support multiple peripherals depending on the device and the number of displays being used. Devices supported include HDDs/SSDs, Audio Interfaces, docks, display devices, cameras, network cables etc.</p> <p>One Thunderbolt™ 5 port (see 4 Figure 1 - 9 on page 1 - 21) supports Power Delivery with DC-In. This port allows you to use a power source, with a USB Type C cable and connector, plugged into the port to charge the computer. Make sure any power source complies with the USB-C PD (Power Delivery) standard specification rated at 20Vdc, 5A or 20Vdc, 3.25A (for off mode charge).</p> <div style="border: 2px solid red; border-radius: 15px; padding: 10px; text-align: center;">  <p>Thunderbolt Port Devices</p> <p>When plugging a device into a Thunderbolt port allow 30 seconds for the system to scan and recognize the connected device. In order to prevent system problems make sure you do not simply pull the cable out from the Thunderbolt port. The hardware must be ejected safely:</p> <ol style="list-style-type: none"> 1. Go to the notification area of the taskbar and click on the Safely Remove Hardware and Eject Media icon. 2. Click on Eject "<i>Thunderbolt Device Name</i>". 3. When you see the "Safe to Remove Hardware" message you can remove the cable after about 20 seconds, to make sure that it is safe to eject the device. </div>

Interface (Ports & Jacks)

Item	Description
<p>USB 3.2 Gen 2 Type A Port</p>  <p>(including 1 AC/DC powered USB Port)</p>	<p>These USB ports are for low-speed peripherals such as keyboards, mice or scanners, and for high-speed peripherals such as external HDDs, digital video cameras or high-speed scanners etc. Devices can be plugged into the computer, and unplugged from the computer, without the need to turn the system off (if the power rating of your USB device is 500mA or above, make sure you use the power supply which comes with the device).</p> <p>USB 3.2 (Gen 2) ports are capable of 10Gbps (SuperSpeed USB 10Gbps).</p> <p>This model includes 2 * USB 3.2 Gen 2 (Type A) ports (Including 1 * AC/DC Powered USB Port) and 2 *Thunderbolt™ 5 Ports.</p> <p>Note: The maximum amount of current supplied by the USB ports is 900 mA for USB 3.2. The maximum amount of current supplied by the Thunderbolt port is 5V/3A in AC mode or 5V/1.5A in DC mode.</p> <p>Note: The powered USB 3.2 Gen 2 port (4 in <i>Figure 1 - 5 on page 1 - 15</i>) (Type A) may be toggled on /off by means of the Fn + Power Button key combination. When the powered USB port is on it will supply power (for charging devices only, not for operating devices) when the system is off but still powered by the AC/DC adapter plugged into a working outlet, or powered by the battery with a capacity level above 20% (this may not work with certain devices - see page <i>7 - 12</i>). Toggle power to this port by using Fn + power button.</p>

A

A - 4 Interface (Ports & Jacks)

Interface (Ports & Jacks)

A

Appendix B: Video Driver Controls

Overview

The video features for this computer can be configured using the **Windows Display Settings**, **Intel Graphics Command Center** or **NVIDIA** control panel.



Video Controller Options

Note that video controller types, specifications and drivers are subject to continual updates and changes. Check with your distributor/supplier for the latest details on video controllers supported.

NVIDIA Advanced Optimus Capable Technology

Most notebook computers come with either a **discrete** or **integrated** graphics solution. The system features both an Intel's Integrated GPU (for power-saving) and an NVIDIA's discrete GPU (for performance). You can switch display devices, and configured display options as long as the video drivers are installed.

Discrete graphics solutions feature a dedicated Graphics Processing Unit (GPU) which are capable of playing games, watching HD video or running GPU-based applications. However computers with discrete graphics solutions tend to be heavy in power consumption, and slightly larger in size in order to incorporate the dedicated discrete GPU.

Integrated graphics solutions usually feature memory sharing technology to help save power consumption and allow for longer battery life. However computers with integrated graphics solutions will not usually run games, HD video or GPU-based applications without severe limitations.

How Switchable Technology works

When the system is powered up and is displaying just the desktop, the dGPU will be powered off. In this case the system is running in the same way as a system without a discrete graphics solution. However when an application that requires use of the dGPU is run (e.g, a game or HD Video), the dGPU is powered on and takes over the processing duties. If the program is closed, then the dGPU will be powered back down again until required.

NVIDIA Advanced Optimus

(For G-SYNC systems)

Note that systems with **G-Sync** displays support **Advanced Optimus** modes which feature **Dynamic Display Switching**. Advanced Optimus allows dynamically switching across different display adapters and this offers longer battery life, along with the performance and benefits of G-Sync and high refresh rate.

Display Mode - BIOS

The Display Mode menu in the BIOS (see “*Display Mode (Advanced Menu > Advanced Chipset Control)*” on page 5 - 13) item allows you to configure the display mode.

Systems supporting **MS Hybrid Graphics Mode** can choose between the following display Modes.

- **MS Hybrid:** The system will **automatically** switch between the Integrated GPU and Discrete GPU as required.
- **Discrete GPU Only:** The system will only use the **Discrete GPU**.



(see over)

Figure B - 1
Advanced Chipset Control > Display Mode (MS Hybrid)

Systems supporting **Advanced Optimus Dynamic Display Switching** can choose between the following display modes.

- **Integrated GPU Only:** The system will use the **Integrated GPU**.
- **Discrete GPU Only:** The system will use the **Discrete GPU** in display mode.
- **Dynamic:** (*Default setting*) The system will **automatically** switch between the Integrated GPU and Discrete GPU as required, and the **NVIDIA Control Panel** will provide the user with three settings in **Manage Display Mode** (see *“Advanced Optimus Modes” on page B - 47*).



Dynamic Mode

If your Advanced Optimus Dynamic Display Switching system is set to **Dynamic** (default) in the BIOS, then you can choose the Display Mode from the NVIDIA control panel (**Manage Display Mode**).

Figure B - 2
Advanced Chipset Control > Display Mode (Dynamic)

Video Driver Installation

Make sure you install the drivers in the order indicated in *Table 4 - 1, on page 4 - 4*. Insert the *Device Drivers & Utilities + User's Manual* disc into an attached DVD drive and click **Install Drivers** (button).

VGA Driver

1. Click **3.Install VGA Driver > Yes**.
2. Click **Begin Installation**.
3. Scroll down to agree to the terms and conditions and click **I agree**.
4. Click **Start**.
5. Click **Reboot now** to restart the computer.
6. **Intel Graphics Command Center** will download but you will need to have a working internet connection.
7. Click the **Start** menu in Windows to access the **Microsoft Store App** tile.
8. Click the **Sign in** icon  and select **Library**.
9. Click **Get Updates**.
10. A list of apps being downloaded will pop-up.
11. When finished the **Intel Graphics Command Center** will appear in the **Windows Start** menu.

Note: After installing the video driver go to the **Display/Display Settings** control panel to adjust the video settings to the highest resolution.

NVIDIA Video (VGA)

1. Click **4.Install NVIDIA VGA Driver > Yes**.
2. Click **Agree and Continue** (button) to accept the terms of the license agreement.
3. Click **Next**.
4. Click **Close** to complete the installation.
5. Go to the Microsoft Store to download the NVIDIA Control Panel.

Note: After installing the video driver go to the **Display** control panel to adjust the video settings to the highest resolution.

NVIDIA App

1. Click **5.Install NVIDIA Apps > Yes**.
2. Click **Agree and Continue** (button) to accept the terms of the license agreement.
3. Click **Next**.
4. Click **Close** to complete the installation.
5. After all the drivers have been installed (an internet connection is required) run the **NVIDIA App** by clicking the desktop icon  (or App).

NVIDIA App

If you have a working internet connection (and you will need remain connected to the internet to run the **NVIDIA App**) you can click the **NVIDIA App** desktop icon  (or app) to run the application. This will optimize your gaming settings for your NVIDIA GPU by downloading the latest settings from NVIDIA.

You may need to create an NVIDIA account to log in to the system (alternatively, you may be able to use your Facebook or Google account, etc, to log in).

After logging in to the system you can click through any on-screen instructions to update your settings and check for installed games etc.

By running the **NVIDIA App**, you can view your game library, download the latest drivers to ensure compatibility with games, adjust program and global settings under **Graphics**, and check your video and performance settings (**Automatic Tuning** will find the best overclock settings for the GPU).

All these features are subject to change and update so check with the **NVIDIA website for the latest information.**

Configure Other Displays Using Project

You can configure attached displays from **Project**.

1. Attach your external display(s) to the appropriate port, and turn it(them) on.
2. Press the **■ + P** (or **Fn + F7**) key combination.
3. Click on any one of the options from the menu to select **PC screen only**, **Duplicate**, **Extend** or **Second screen only**.
4. Press the **■ + K** key combination, or, go to the **Display** settings menu and select **Connect to a wireless display** and then click **Connect**.

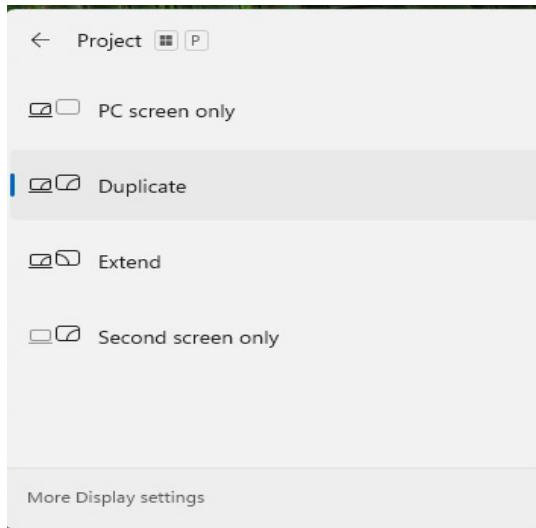

Figure B - 3
Project

Configuring an External Display In Windows

The **System > Display** Control Panel in **Settings** can be used to configure displays.

1. Attach your external display to the appropriate port, and turn it on.
2. Click the Start Menu and click **Settings > System > Display** (or right-click the desktop and select **Display Settings**).
3. Click the **Multiple Displays** menu and select **Duplicate these displays**, **Extend these displays** or **Show only on 1/2**.
4. Click **Keep changes** to save any changes made.
5. You can configure up to **4 displays** (including the notebook display) from the **Settings > System > Display** menu.

Figure B - 4
Settings > System > Display
(Multiple Displays)



HDMI Audio Configuration

HDMI (High-Definition Multimedia Interface) carries both **audio** and video signals. In some cases it will be necessary to go to the **Sound** control panel and manually configure the HDMI audio output as per the instructions below.

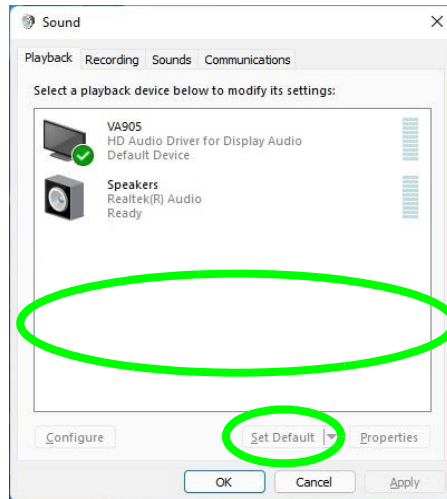

1. Go to the **Sound** control panel, and click **Playback** (tab).
2. You may need to select the audio device and click **Set Default** (button).
3. Double-click the device to access the control panel tabs.



4. Adjust the HDMI settings from the control panel tabs.
5. Click **OK** to close the **Sound** control panel.



Volume Adjustment

The sound volume level can be adjusted from the **Action Center** in Windows by clicking the battery icon  (or use the **Windows Logo Key**  + **A** key combination) in the notification tray.

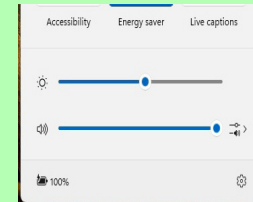

Figure B - 5

**Sound - HDMI
Device (Set Default)**

Video Driver Controls



Other Applications

If you are using a third party application to play DVDs etc. from any attached DVD device, you will need to consult the application's documentation to see the appropriate audio configuration (the application must support digital to analog translation).

HDMI Notes

- Connect a device with HDMI support to the HDMI-Out port **BEFORE** attempting to play audio/video sources through the device.
- To play audio sources through your external display's (TV or LCD) speakers you will need to go to the audio configuration control panel on the display and configure the audio input accordingly (see your display device manual).

HDMI Video Configuration

1. Connect an HDMI cable from the HDMI-Out port to your external display.
2. Configure your external display as per the instructions in *“Attaching Other Displays” on page B - 28.*
3. Set up your external display (TV or LCD) for HDMI input (see your display device manual).
4. You can now play video/audio sources through your external display.

Wireless Display Configuration

1. Note that no driver or application is required for wireless display in **Windows 11**.
2. Press the **Win + K** key combination, or, go to the **Display** settings menu and select **Connect to a wireless display** and then click **Connect** (make sure you have a wireless connection and click **Detect** to refresh).

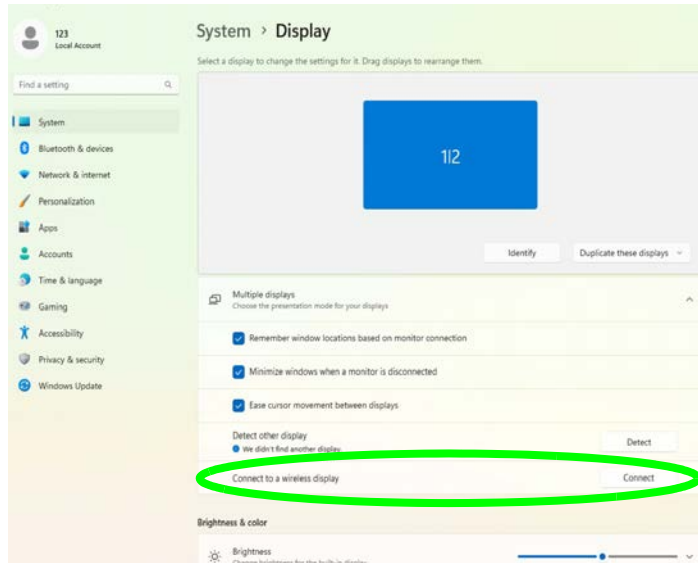

Figure B - 6
**Settings . System >
Display
(Connect to a
Wireless Display)**

3. The system will then search for compatible display devices (**this may take up to 60 seconds** so allow time for this to complete).

Video Driver Controls

4. Double-click any detected display device in the list.
5. You may then need to input a pin number for the device to which you are connecting and click **Next**.
6. The display will then connect (for specific settings for your display see the documentation supplied with your compatible adapter/display for full details).
7. Go to the **Project** menu and click **Disconnect** to temporarily disconnect from the wireless display.
8. To permanently disconnect from the display (you will need to go back through the connection process again) you can select it in **Devices** and click **Remove Device** > **Yes**.

Intel® Graphics Command Center

Advanced video configuration options are provided by the **Intel Graphics Command Center**.

1. Access the **Intel Graphics Command Center** from the **Start** menu in **Windows** (click **All apps** and scroll down to **Intel Graphics Command Center**).
2. You can **right-click** the **Intel Graphics Command Center** in the Start menu and pin the control panel to Start and/or taskbar.

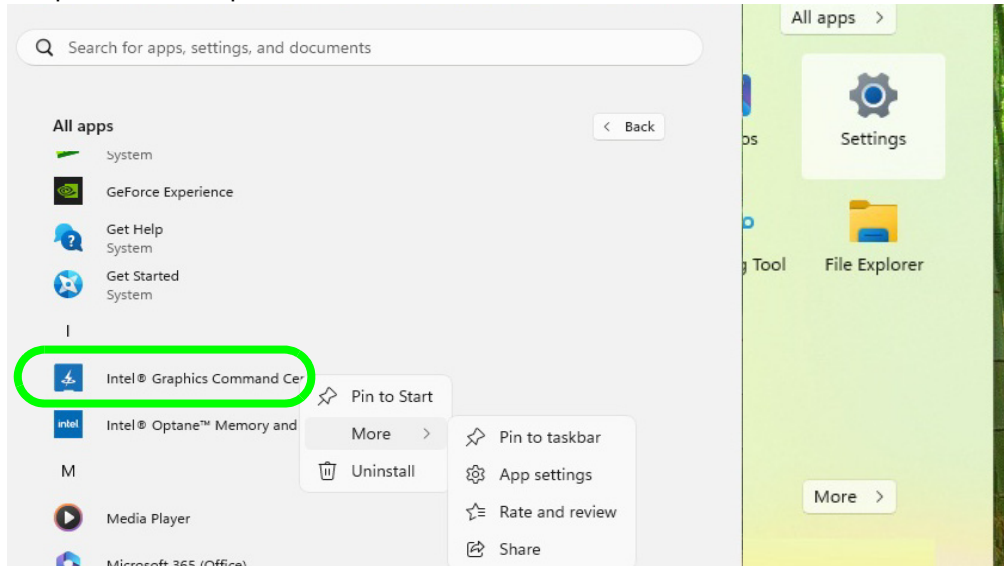

Figure B - 7
**Intel® Graphics
Command Center
(Windows Start
Menu)**

Video Driver Controls



Home

Click the Home button to return to the main menu screen in any of the sub-menu screens.

You may make changes to any of the graphics properties by clicking the appropriate icon on the left and you and then adjust the settings from the sub-menus.

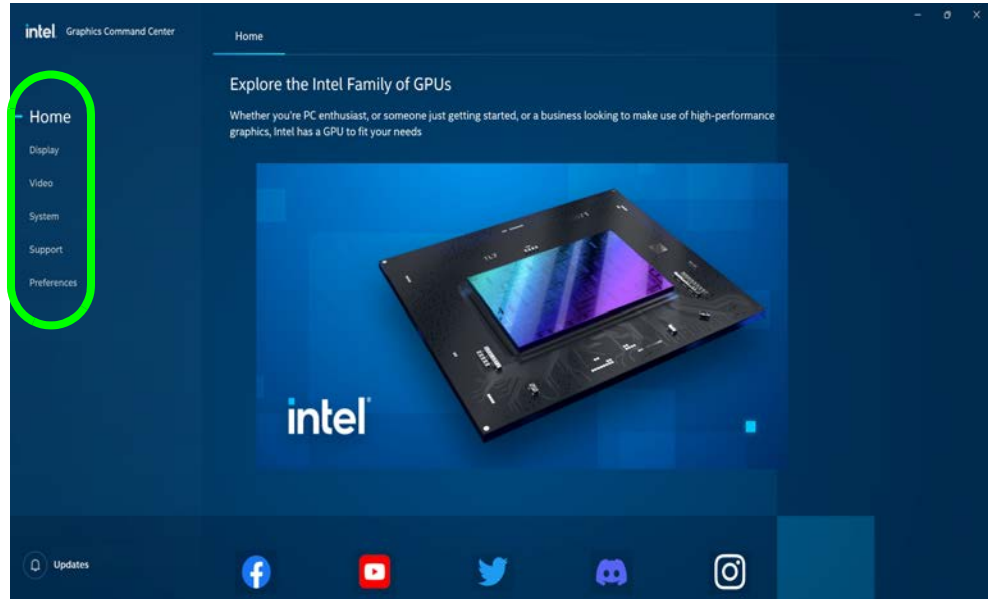
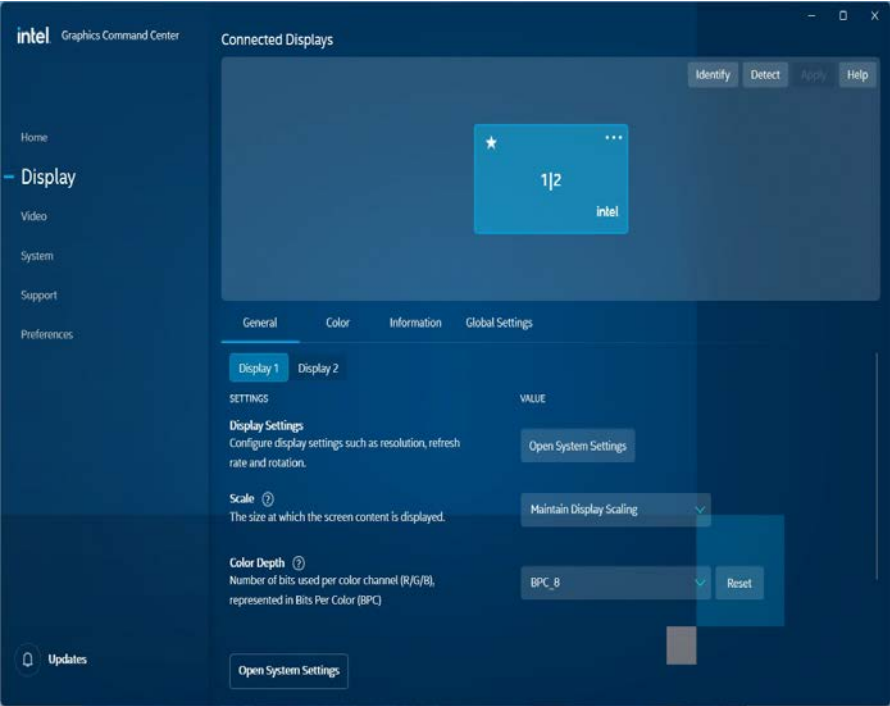



Figure B - 8
**Intel® Graphics
Command Center
(Home Screen)**

B

Display

Click either **General**, **Color**, **Information** or **Global Settings** to make display adjustments, including configuration for any attached external displays.





Multiple Display

At least one other display must be attached in order to view multiple display selection options.

Figure B - 9
Intel® Graphics Command Center (Display Screen)



Video Driver Controls



Custom Resolutions

The Custom Resolutions sub-menu allows you to adjust **supported displays** to any Timing Standard, Width, Height, Refresh Rate and Underscan percentage of your choice.

Note that incorrect settings can cause system instability and even possible component damage, so this is adjusted at your own risk.

Use the **Display** menu to adjust the display's Resolution, Refresh Rate, Scale, and Rotation, and to access the Display control panel in System Settings.

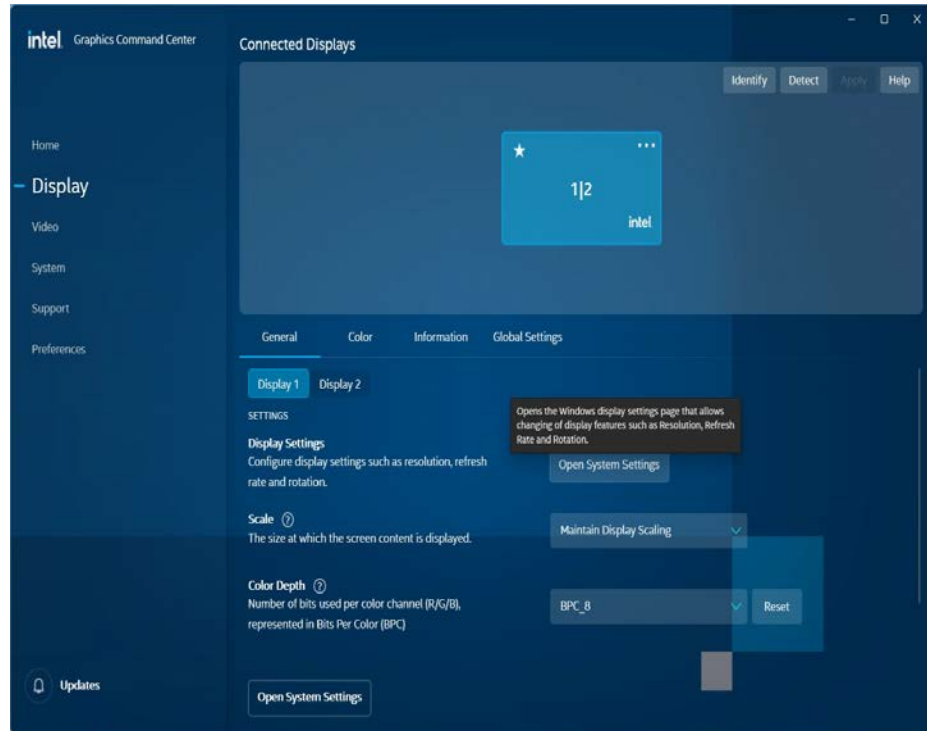
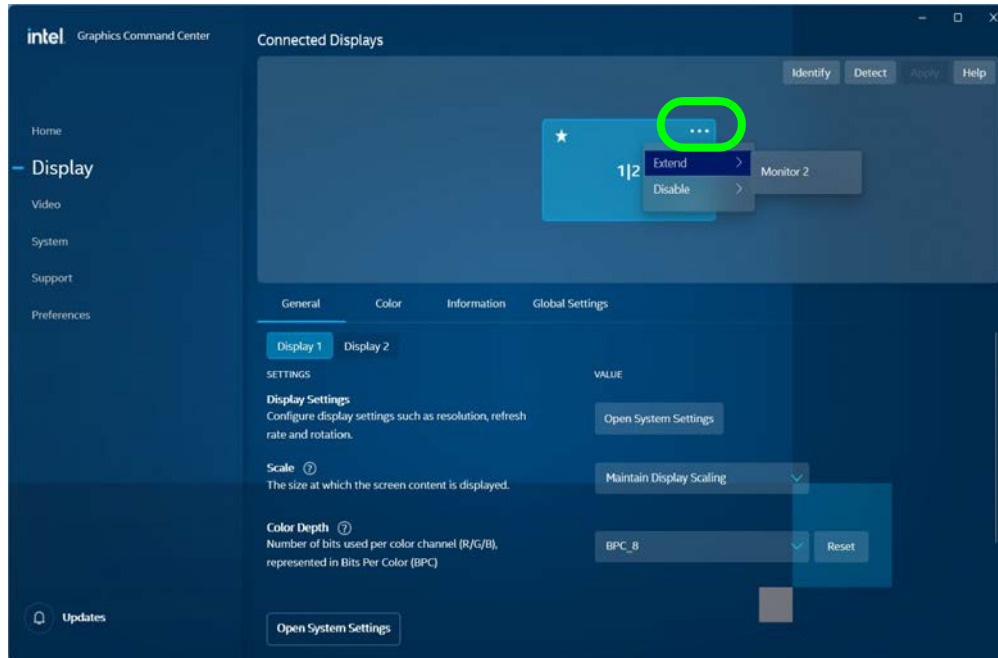

Figure B - 10
Intel® Graphics Command Center (Display)

When external displays are attached you can use the **Connected Displays** control panel to configure **multiple displays** (see *“Attaching Other Displays” on page B - 28*). Click on the **dotted lines** at the top right of the display graphic to access the settings options and click **Apply** to save any changes made.



Multiple Display

At least one other display must be attached in order to view multiple display selection options.

Audio Settings

Any attached active displays must have audio capacity to allow audio configuration.

Figure B - 11
**Intel® Graphics
Command Center
Connected Displays**

Video Driver Controls

Display (Color)

Use the color sliders from the menu to make changes to the display. If you wish to revert to the default settings simply click on **Restore to Original Colors**.

Figure B - 12
Intel® Graphics Command Center
(Display - Color
Screen)

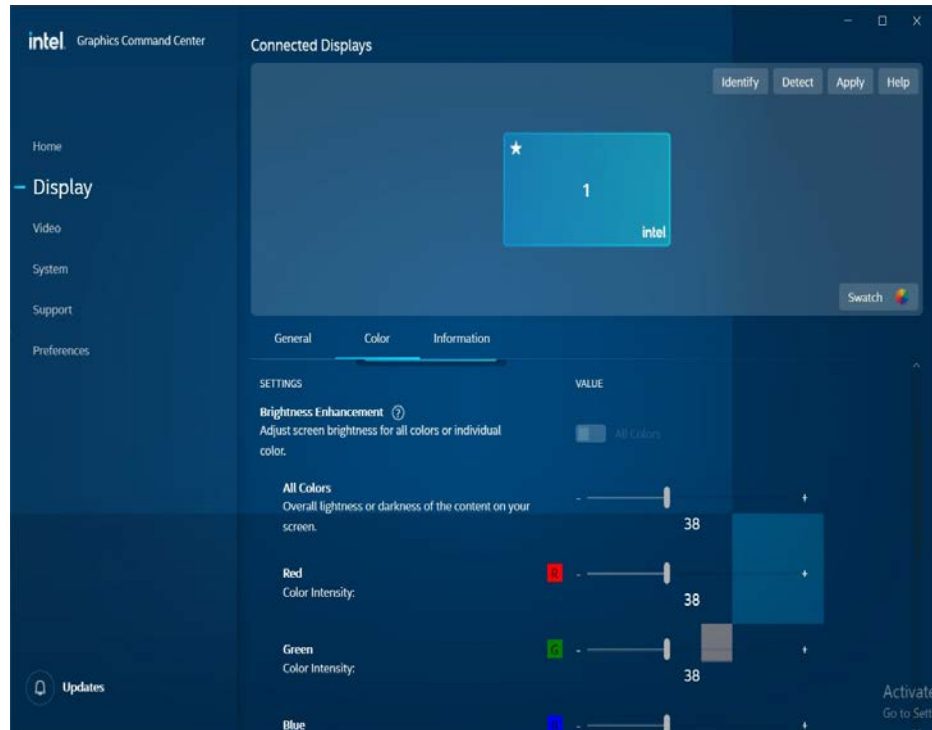

B

Information

Information provides details on any attached displays.

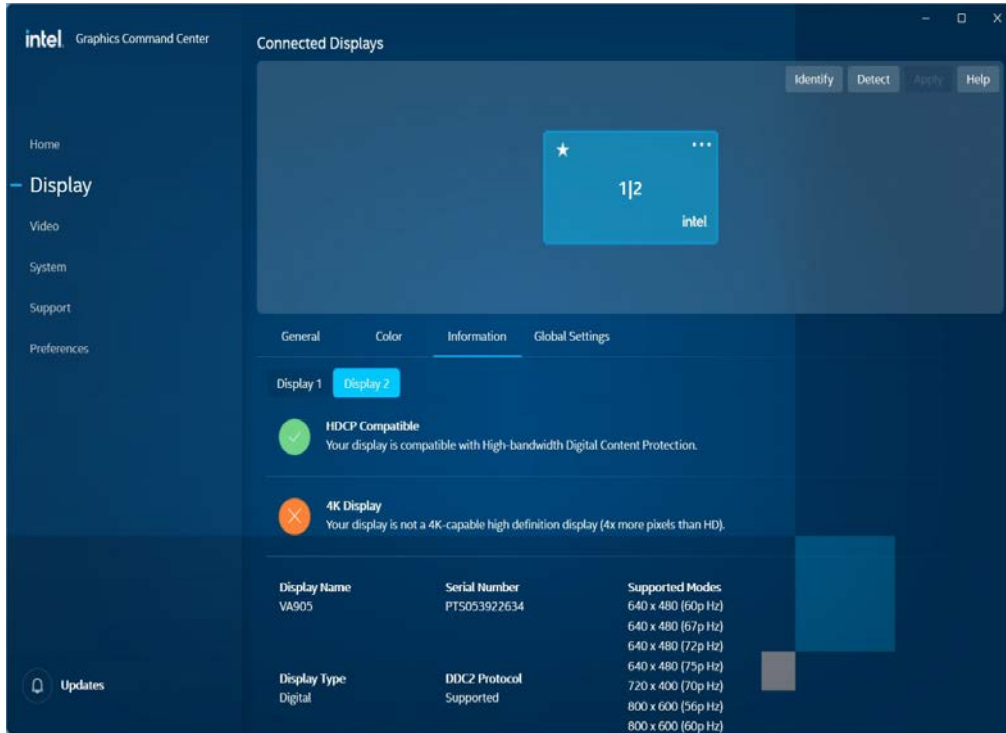

Figure B - 13
Intel® Graphics
Command Center
(Display -
Information)

B

Global Settings

Configure the Adaptive Sync settings for fast frame rates which sync with the display's refresh rate for a fluid gaming experience.

Figure B - 14
**Intel® Graphics Command Center
(Display - Global Settings)**

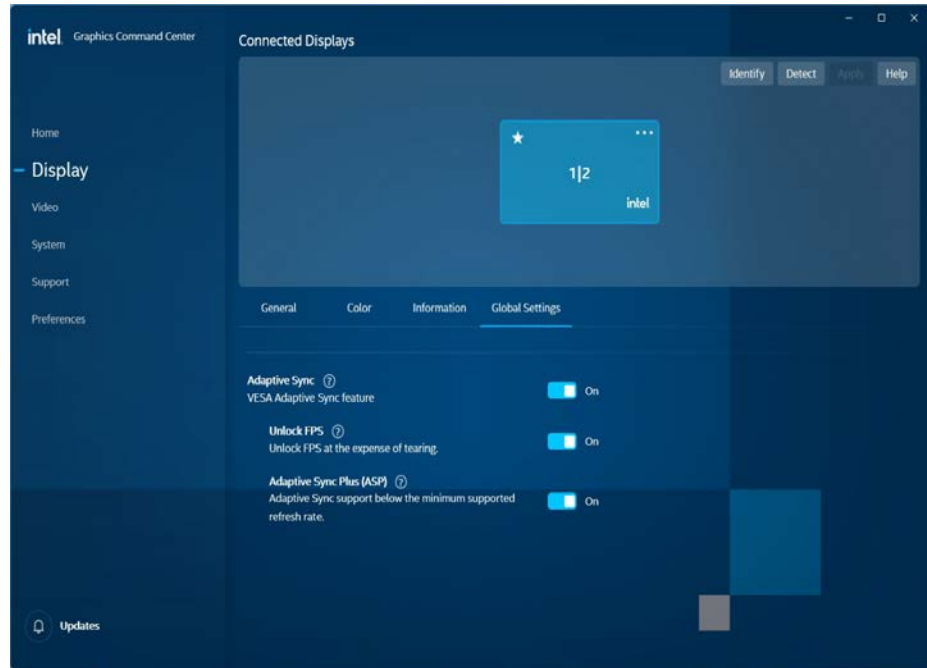

Video

The **Video** menu allows you to brighten or darken movies, adjust colors and a range of other video options. The **Preview** image will display a sample image using the current settings, and you can click **Add Video** to select your own sample video. You will need to click **Custom** to create a **custom profile** to make adjustments to most of the settings and you can rename, duplicate or delete custom profiles.

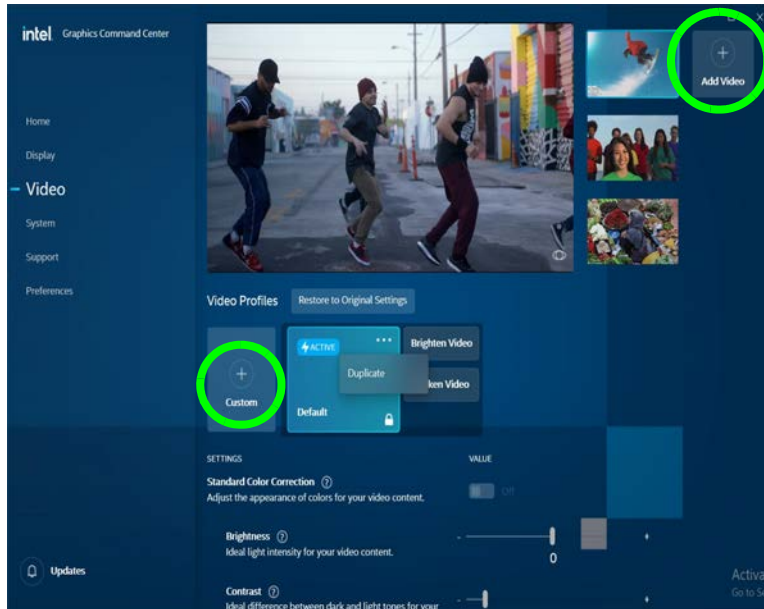

Figure B - 15
Intel® Graphics
Command Center
(Video)

Video Driver Controls

System

Hot Keys in **System** allows you to create and enable/disable hot keys for opening the application and display rotation etc. Click **Apply** to save changes. The other tabs provide information on your current GPU, Hardware and Power configuration.

Figure B - 16
Intel® Graphics Command Center
(System - Hotkeys)

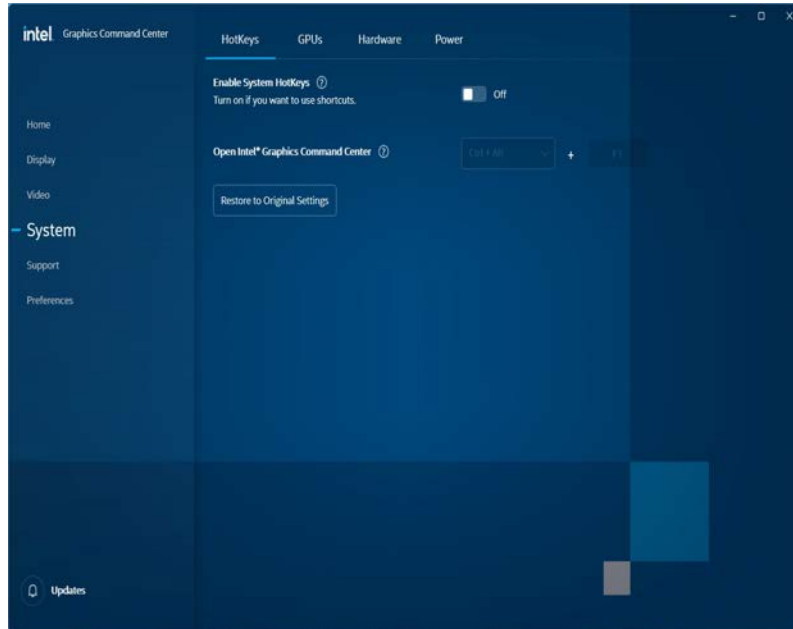

B

Support

Online Resources in **Support** provides links to online support for Intel graphics issues and to the latest drivers. The **System Diagnostic** tab allows you to **Generate Report** on the graphics system (as may be required by online help services).

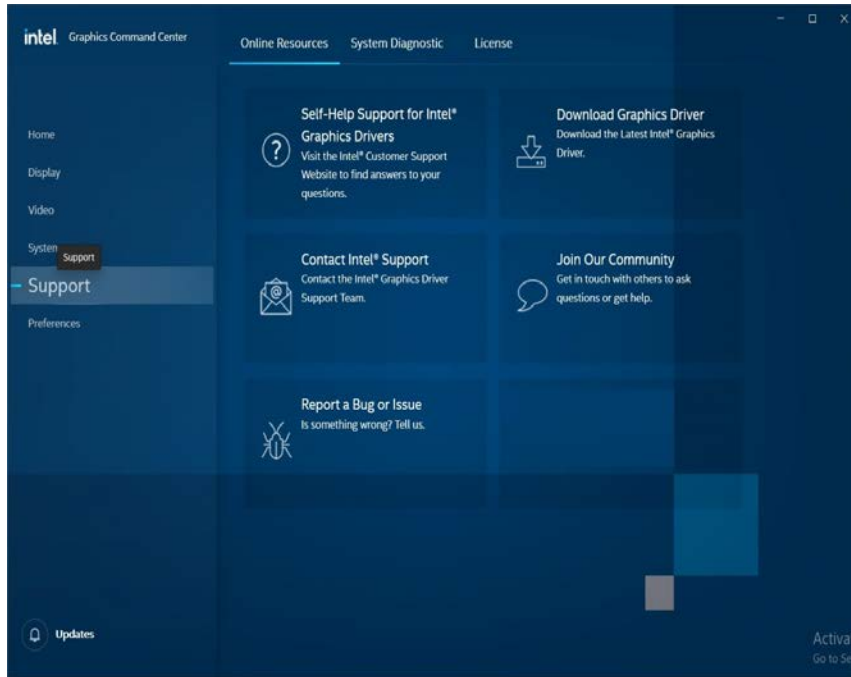

Figure B - 17
Intel® Graphics Command Center (System - Support)

B

Preferences

You can configure the app to your preferences from this menu.

Figure B - 18
**Intel® Graphics Command Center
(Preferences)**

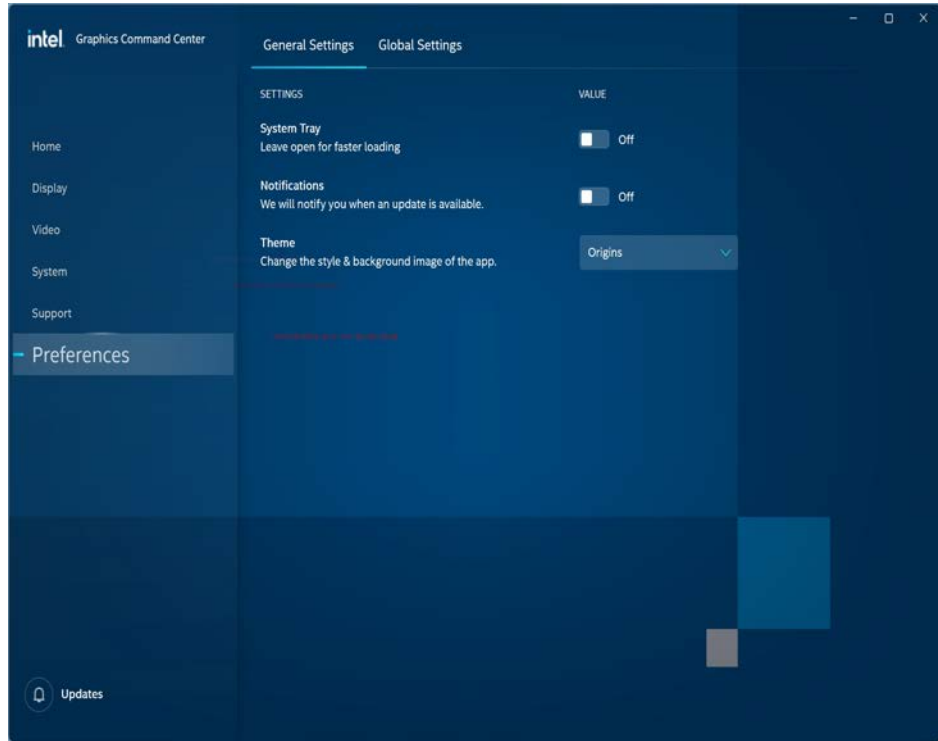

Display Devices & Options

You can use external displays connected to the HDMI-Out port or Thunderbolt Ports. See your external display device’s manual to see which formats it supports.

Display Mode	Description
Single Display	One of the connected displays is used as the display device (PC screen only or Second screen only).
Clone / Duplicate	Both connected displays output the same view and may be configured independently
Extended / Extend	Both connected displays are treated as separate devices, and act as a virtual desktop



Attaching Displays

When you first attach an external display you may find that the desktop does not occupy the full screen area. Use either the display’s auto adjust/configure controls, or the Intel Graphics Command Center to configure the full screen display.



4K2K Videos on 4K2K External Displays

Note you may experience some video lag when playing 4K2K videos on an attached 4K2K external display.

Configuring External Displays

When multiple external display are attached it is recommended that you use the System (in Settings) control panel or the  + P (or Fn + F7) key combination, to configure the external displays.



Table B - 1
Display Modes



Connected Displays

At least one other display must be attached in order to view **Connected Displays** selection options.

Attaching Other Displays

To Mirror Displays:

1. Attach your external display to the appropriate port, and turn it on.
2. Go to the **Intel Graphics Command Center** and click the **Display** menu button.
3. Click **Detect** if you need to scan for any attached displays.
4. The system should automatically be in **Mirror** mode,
5. If not, click on the dotted lines at the top right of the display graphic to access the settings options and select **Mirror** and the Monitor #.
6. Click **Apply** to confirm any settings change if necessary.

Figure B - 19
Display > Mirror

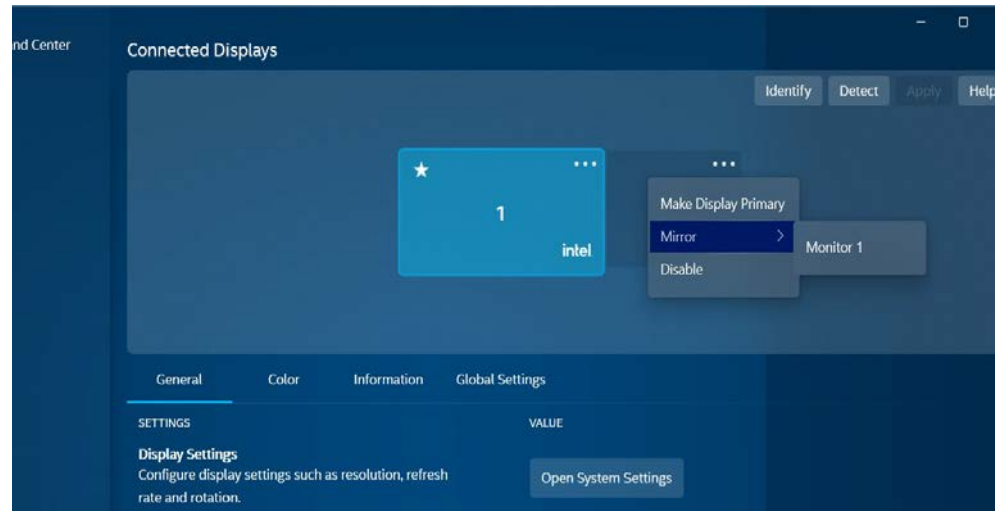

To Enable Extend Mode:

1. Attach your external display to the appropriate port, and turn it on.
2. Go to the **Intel Graphics Command Center** and click the **Display** menu button.
3. Click **Detect** if you need to scan for any attached displays.
4. Click on the dotted lines at the top right of the display graphic to access the settings options and select **Extend** and the Monitor #.
5. Click **Apply** to confirm any settings change if necessary.

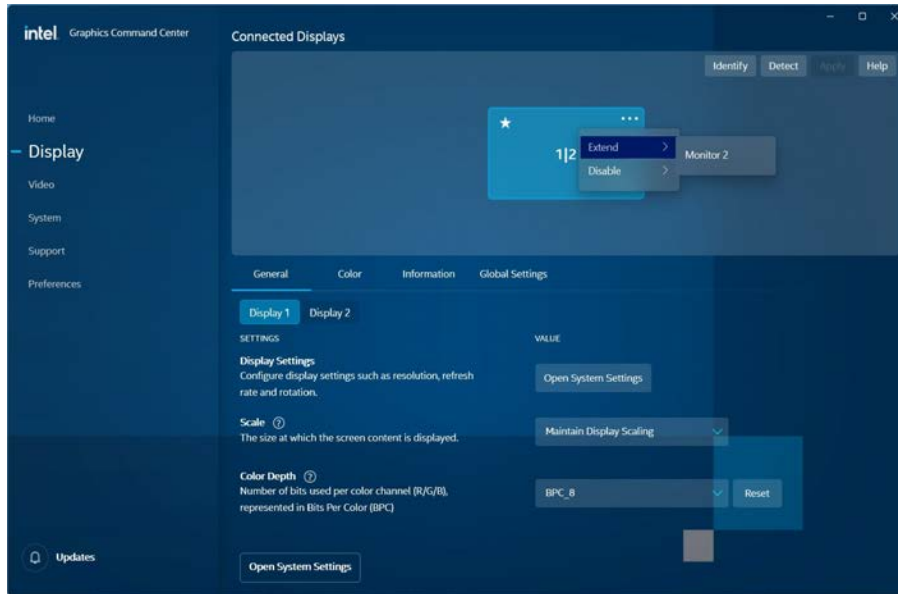

Figure B - 20
Display > Extend

Video Driver Controls

6. You can have different resolutions, monitor refresh rates, scales, rotations and aspect ratios for each display device **provided your display can support them**.
7. You can drag the display icons to match the physical layout of your displays.
8. Icons and programs may also be dragged between the displays.

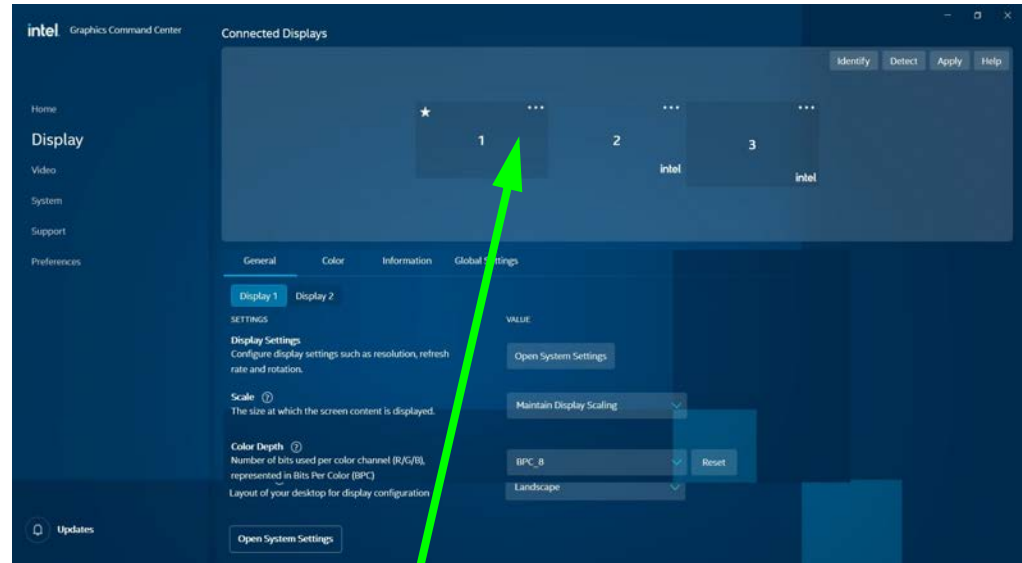

Figure B - 21
Display > Extend
(Drag Display)

Click the appropriate monitor icon and drag it to match the physical arrangement you wish to use (e.g. the secondary display may be extended left/right/above/below the primary display).

NVIDIA Control Panel

The **NVIDIA Control Panel** provides additional video configuration controls and tools which allow quick access to features such as image settings, 3D Settings and PhysX configuration.

1. Access the **NVIDIA Control Panel** from the **Start** menu in **Windows** (click **All apps** and scroll down to **NVIDIA Control Panel**).
2. You can **right-click** the **NVIDIA Control Panel** in the Start menu and pin the control panel to Start and/or taskbar.

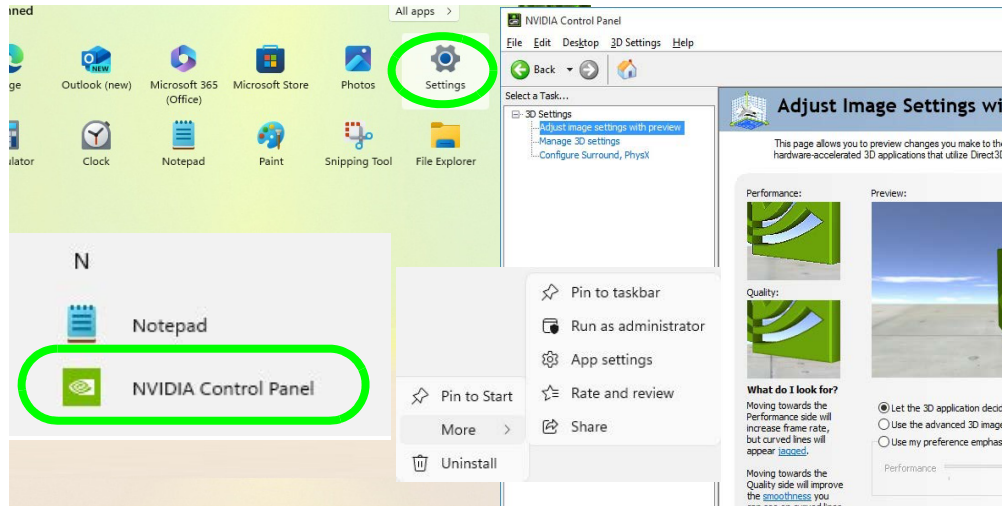

Navigating the Control Panel

Navigate through the control panels in much the same way as you would a web page. Click on the sub-heading tasks in the left menu (and on the highlighted links) for information. Use the buttons on the top left to go back, forward etc.

B

Figure B - 22
NVIDIA Control Panel (Basic)

Video Driver Controls

The **Help** menus provide index and search features, and direct links to the NVIDIA website etc.

Figure B - 23
Help Menu

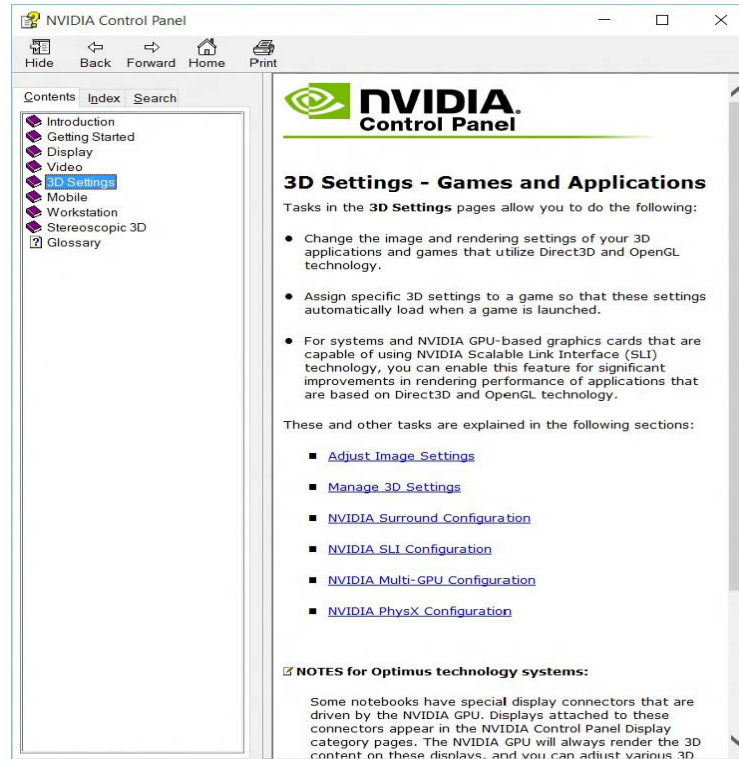

Adjust Image Settings with Preview

This page allows you to preview 3D image settings and you can let the application decide, adjust the settings from the control panel (see over) or use the slider towards either quality or performance.

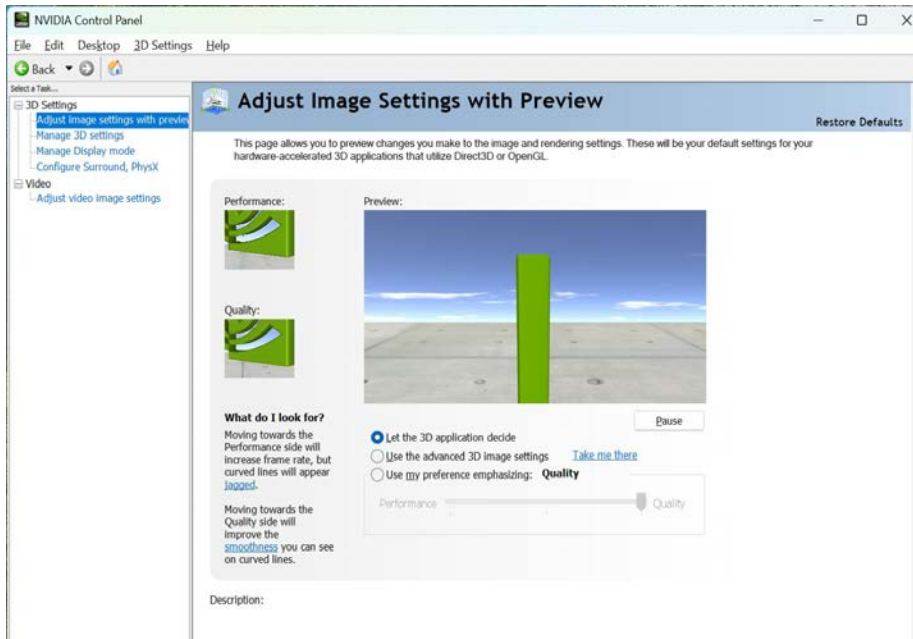

Figure B - 24
Adjust Image
Settings with
Preview

Manage 3D Settings

Hybrid technology will switch between the integrated GPU and discrete GPU seamlessly and automatically without input from the user. However customization options are offered for users who prefer to set their own parameters for GPU usage.

Global Settings

Global settings allows you to set the preferred graphics processor for overall use. Ideally this would be the iGPU for battery life, but this can be set to the dGPU if preferred.

1. Go to the **NVIDIA Control Panel**.
2. Click **Manage 3D Settings (3D Settings)** and select **Global Settings** (tab).
3. Select either **Integrated graphics (iGPU)** or **High performance NVIDIA Processor (dGPU)** from the drop-down menu.
4. Click the **Setting** menu items to select any options required.
5. Click **Apply** to save the settings.

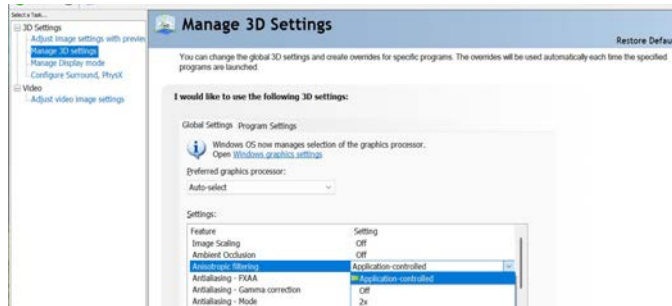

Figure B - 25

NVIDIA Control Panel - Manage 3D Settings

Program Settings

Program settings allows you to make specific adjustments for installed applications.

1. Go to the **NVIDIA Control Panel**.
2. Click **Manage 3D Settings (3D Settings)** and select **Program Settings** (tab).
3. The Windows OS manages selection of the graphics processor so click **Open Windows Graphic Settings**.

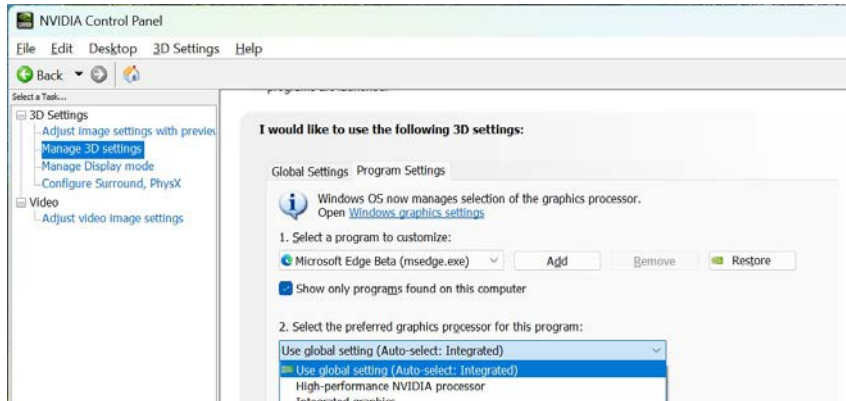

Figure B - 26
Program Settings
(Windows Graphic
Settings)

4. Click the **On** button under **Hardware-accelerated GPU scheduling**.
5. You will then need to restart the computer to apply the settings.
6. After the restart go to the NVIDIA Control Panel.
7. Click **Manage 3D Settings (3D Settings)** and select **Program Settings** (tab)
8. **Select a program to customize** from the drop-down menu, or click **Add** to add any program that does not appear in the menu.

Video Driver Controls

9. Select the preferred graphics processor for the program from the drop-down menu.
10. Click the **Setting** menu items to select any options required.
11. Click **Apply** to save the settings.

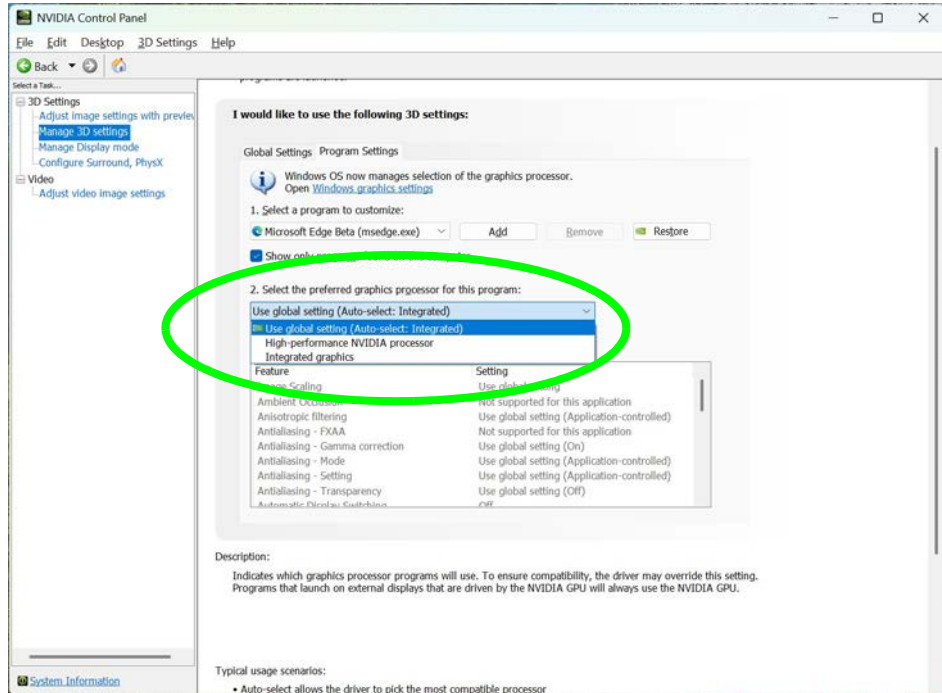

Figure B - 27
**Program Settings
(Select Graphics
Processor)**

B

Configure Surround, PhysX®

NVIDIA® PhysX® is a physics engine that can use the GPU to accelerate game and 3D application performance. You can select the GeForce video card or CPU as a PhysX® processor, or configure the computer to auto-select a PhysX® processor (recommended default setting). You can also setup **Surround configuration** to combine up to three external multiple displays into a single unified display.

1. Go to the **NVIDIA Control Panel**.
2. Click **Configure Surround, PhysX**.
3. Click to select a processor from the menu (**PhysX Settings**); Auto-select (recommended) is the default setting.
4. Click **Apply** to save the settings or see the next steps for **Surround configuration**.

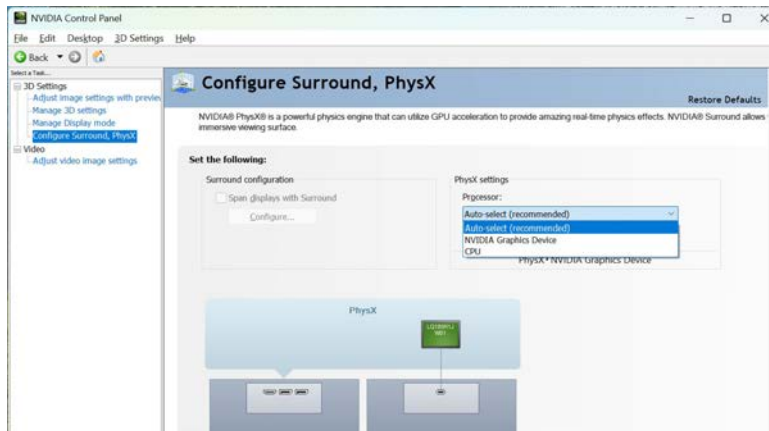

Figure B - 28
**Configure Surround,
PhysX**

B

Video Driver Controls

- When other displays are connected you can click **Span displays with Surround** and click **Configure**.

Figure B - 29
Surround
Configuration

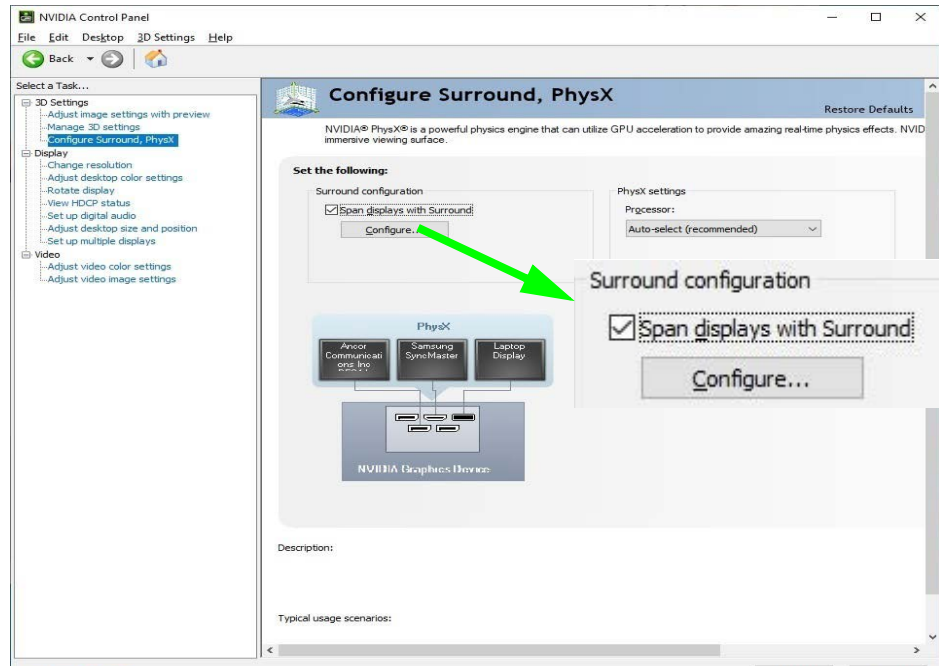

- You may need to quit any applications which conflict with surround display (e.g. you may need to quit **Sound Blaster Pro**).

- The **NVIDIA Set Up Surround control panel** will pop-up to allow you to configure the attached displays to your requirements.

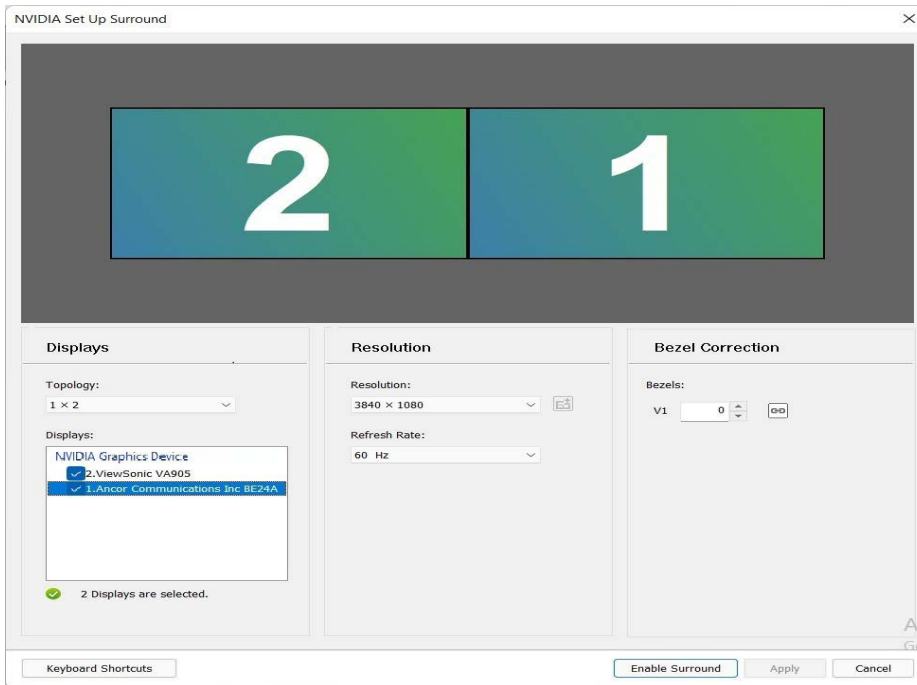

Figure B - 30
NVIDIA Set Up Surround

Set Up Surround Settings

Select the **Resolution** and **Refresh Rate** for your connected displays from the menu.

The **Bezel Correction** section you can adjust the monitor Bezel (The outside frame of the monitor) so that the displays are aligned correctly.

- Click to select displays from the **Display** menu (and set the **Topology**) and click **Enable Surround** and **Apply** to save any changes made.

Video Driver Controls

Additional menus will appear when external displays are attached..

Figure B - 31
NVIDIA Control
Panel

With External Displays
Attached

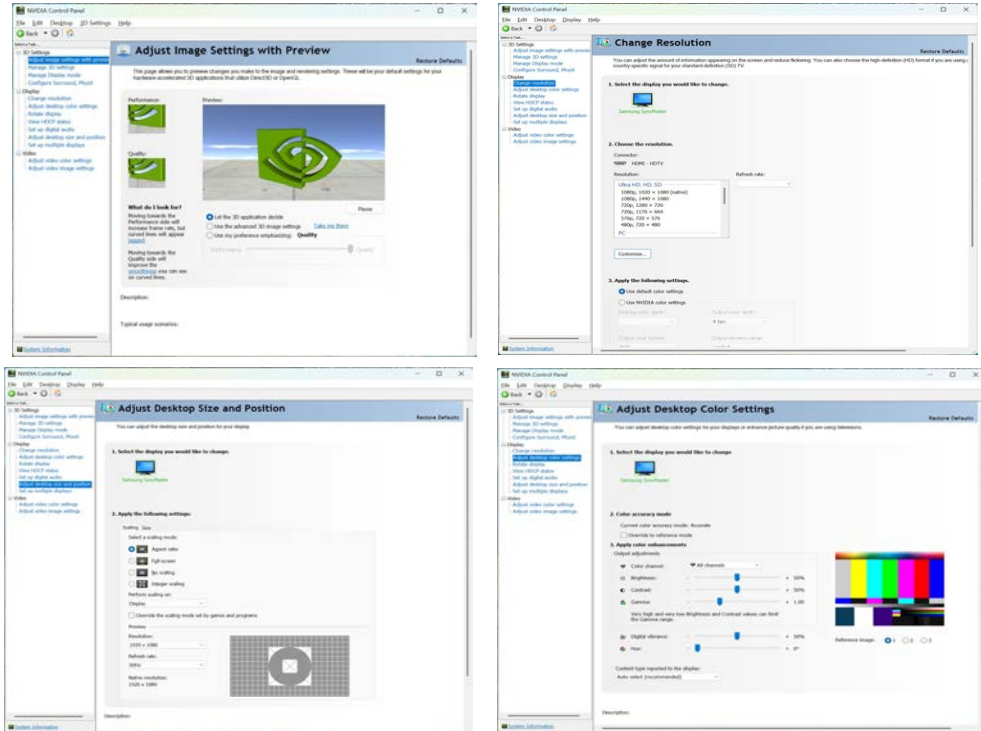

B

Change Resolution

You can **Change Resolution** for your attached displays from the NVIDIA control panel.

1. Attach your external display to the appropriate port, and turn it on.
2. Go to the **NVIDIA Control Panel**.
3. Double-click **Display** (if the sub-menus are not visible), and then click **Change resolution**.
4. Click to select the display, and then adjust the settings from “**2.Choose the resolution.**” and “**3.Apply the following settings.**”
5. Click **Apply** to save the settings.

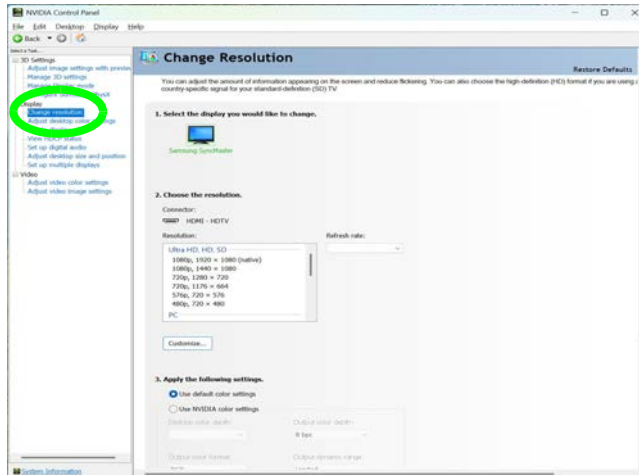

Figure B - 32
Change Resolution

B

Set Digital Audio

As HDMI (High-Definition Multimedia Interface) carries both **audio** and video signals you can configure the audio output from the **NVIDIA control panel** and **Sound** control panel. The settings will depend upon the external HDMI display to which you have connected.

Connected displays will appear alongside the appropriate port. Click *“Open Windows Sound Settings”* (button) to access the **Sound** control panel.

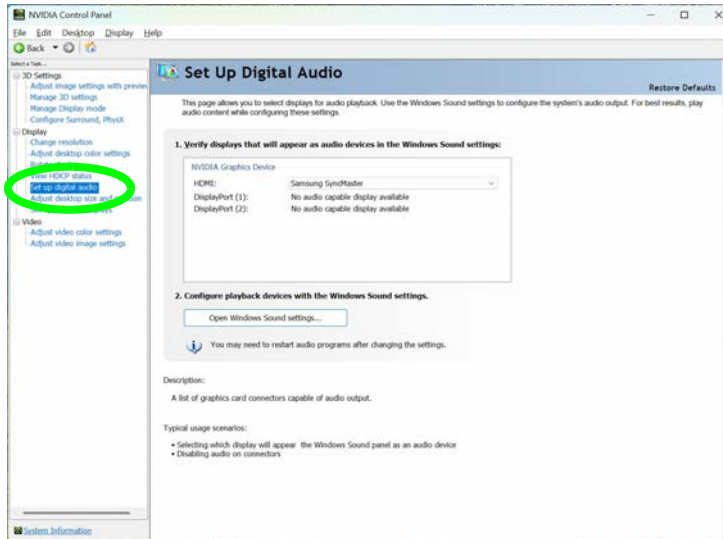

Figure B - 34
Set up Digital Audio

B

Adjust Video Settings

You can adjust video color and image settings from the **Video** sub-menus.

1. Go to the **NVIDIA Control Panel**.
2. Click “+” next to **Video** if its sub-items are not shown and then click either **Adjust video color settings** or **Adjust video image settings**.
3. Make any adjustments required for any display and click **Apply** to save the settings.

Figure B - 35
Adjust Video Color Settings

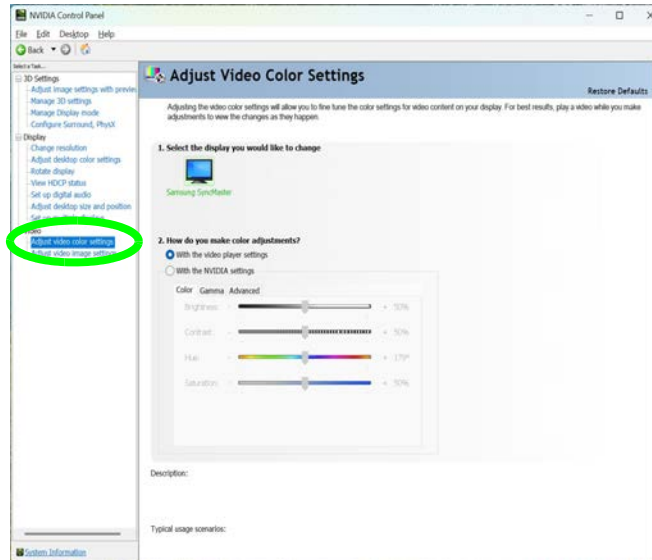

Manage Display Mode

(Only for systems supporting Advanced Optimus Dynamic Display Switching)

Note that systems supporting Advanced Optimus Dynamic Display Switching allow dynamic switching across different display adapters, and this offers longer battery life, along with the performance and benefits of G-Sync and high refresh rates.

1. Go to the NVIDIA control panel and select **Manage Display Mode** (note that this menu item will only appear if the **Display Mode in the BIOS (see page B - 5) is set to Dynamic**) to adjust the settings.

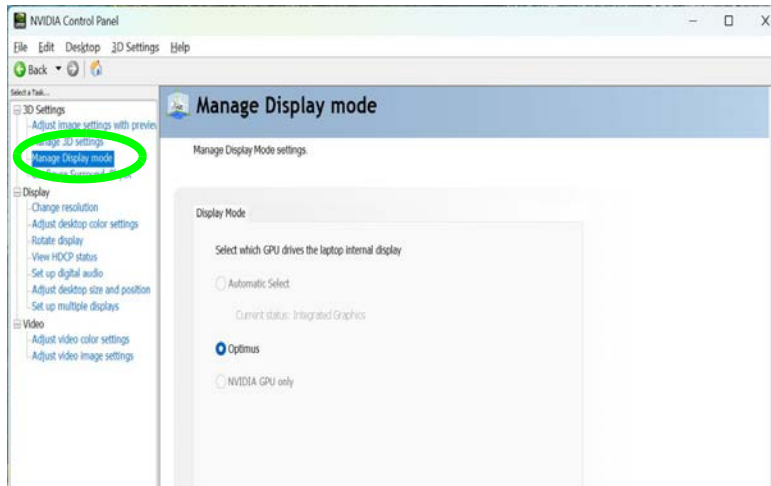

Figure B - 36
**Manage Display
Mode**

Video Driver Controls

2. Select the Display Mode from the menu (note you may need to unplug attached displays).
3. Click **Apply** to update the changes.
4. **If you have applied the settings** to change to **NVIDIA GPU Only**, then the full range of menu options will appear, including Set up G-Sync.

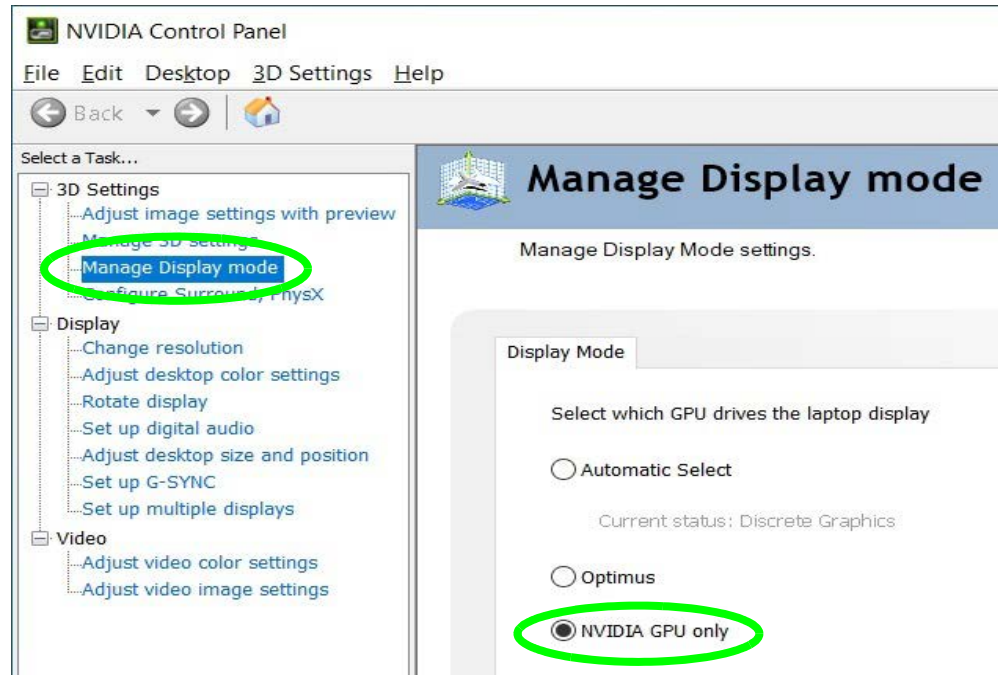

Figure B - 37
**Manage Display
Mode (NVIDIA GPU
Only)**

B

Advanced Optimus Modes

Systems supporting **Dynamic Display Switching** will provide the user with three settings in Manage Display Mode (under the **Dynamic** default BIOS setting - see page [B - 5](#)). Systems supporting **MS Hybrid Mode** should use the BIOS settings (see *“Display Mode - BIOS”* on page [B - 4](#)).

Automatic Select (Default)

With this option any applications launched in the DDS allow will trigger a display switch to the **discrete GPU**. The display switches back to **integrated GPU** only when the last application that is in allow list, is closed.

Optimus

This mode will behave like **MS Hybrid** system. The display will switch to the integrated GPU no matter what application is running or the system power state. In this case rendering follows the program settings or global settings' page in Manage 3D settings (see *“Manage 3D Settings”* on page [B - 34](#)).

NVIDIA GPU only

If this option is selected, the internal display will switch to **discrete GPU** no matter what application is running or the system power state.

Advanced Optimus Modes Notes

When the internal display is switched to discrete GPU (with no external display connected), the user will see two displays in the **System > Display Control Panel in Settings**, with the discrete GPU's internal display enabled and the integrated GPU's internal display disabled.

Video Driver Controls

Users can change the list of applications which trigger a display switch using program settings or global settings' page in Manage 3D settings (see *“Manage 3D Settings” on page B - 34*).

The display will not switch to discrete GPU if:

- The application in allow list is a DirectX9 application.
- There is a DirectX9 application already running.
- The system is running in battery mode.
- There are any external monitors connected to the system
- An external-GPU (eGPU) is connected to the system.

If any DX9 application is running and a display switch is triggered using the NV Control Panel display mode settings page, the DX9 app may crash or freeze.

A display switch between integrated and discrete GPUs can freeze the screen for few seconds

Upon closing the last application that is in allow list, the switch back to integrated GPU is triggered after a delay of few seconds.

If a user uses a docking station with external displays connected for charging purposes, they cannot take advantage of the Advanced Optimus feature until they switch to a power adapter for charging their notebook.

G-SYNC

(Only supported by a G-SYNC capable display in Dynamic Display Switch Mode). Click to put a check in the box **Enable G-SYNC** (it is enabled by default). G-SYNC is designed to provide a smooth game play experience from your GeForce product by synchronizing the monitor's refresh cycle to the GPU's render rate, thus removing lag and stutter issues, in order to have objects appear sharper and scenes display instantly.

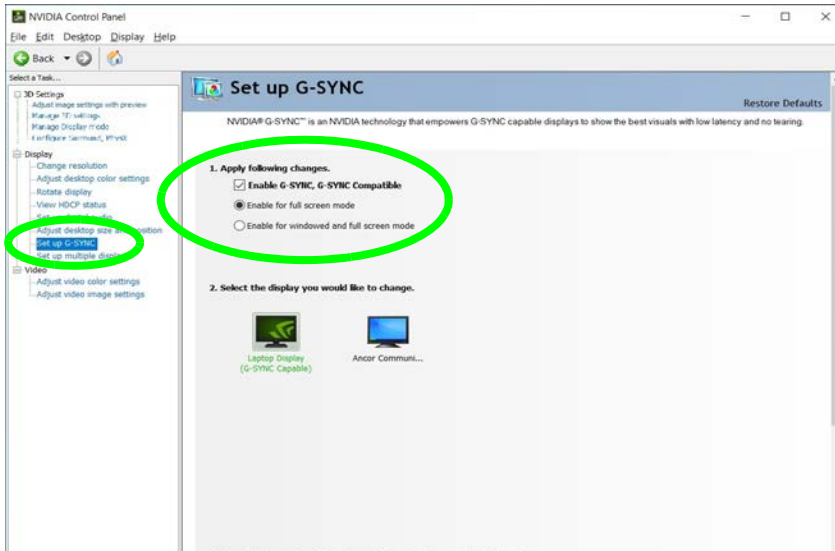

G-SYNC Support

NVIDIA® G-SYNC™ Technology (supported by some LCD panels only).

G-SYNC is only supported if you have a G-SYNC capable display (contact your distributor or supplier for details).

B

Figure B - 38
Set Up G-SYNC



Thunderbolt Port Cable Connection

Note that USB Type C to HDMI adapter cables cannot be used with the Thunderbolt port connection. In this case you should use a cable connected to a DisplayPort on your external display.

Display Devices - NVIDIA CP

You can use the NVIDIA control panel to configure external displays.

You can use external displays connected to the HDMI-Out port or Thunderbolt Ports. See your external display device's manual to see which formats it supports.



Configuring External Displays

When multiple external display are attached it **is recommended** that you use the **System** (in **Settings** - page **B - 10**) control panel or the  + P (or Fn + F7 - page **B - 9**) key combination, to configure the external displays.

External displays can also be configured the **Intel(R) Graphics Command Center** (see page **B - 27**).

You can also use the **NVIDIA** control panel to configure the external displays.

Display Mode	Description
Clone	Clone simply shows an exact copy of the Primary display desktop on the other displays. This mode will drive multiple displays with the same content.
Extend	Extend treats connected displays as separate devices, and they act as a virtual desktop resulting in a large workspace. When enabled, you can drag any icons or windows across to the other display desktop. It is therefore possible to have one program visible in one display, and a different program visible in the other display.

Table B - 2
Display Modes
NVIDIA



Display Not Shown

If the attached display does not appear in the “1.Select the displays you want to use.” window, click “My Display is not shown...” and then click the appropriate button to force detection of the missing display.

HDMI Audio Setup

See “HDMI Audio Configuration” on page B - 11 for instructions on configuring audio for HDMI display devices.

Configuring an External Display (NVIDIA)

Clone the External Displays

1. Attach your external displays to the appropriate port, and turn them on.
2. Go to the **NVIDIA Control Panel**.
3. Double-click **Display** (if the sub-menus are not visible), and then click **Set up multiple displays**.
4. Any attached display will appear under “1.Select the displays you want to use.”

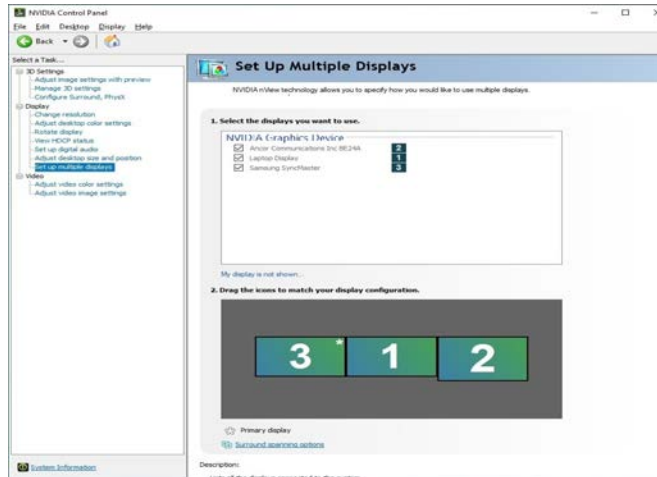

5. Click the check box alongside any display you wish to use.
6. Click **Apply > Yes** to save any changes made (the **Apply** button will appear in the bottom right of the control panel when changes have been made).

Figure B - 39

Set Up Multiple Displays

Extending the Display

1. Attach your external displays to the appropriate port, and turn them on.
2. Go to the **NVIDIA Control Panel**.
3. Double-click **Display** (if the sub-menus are not visible), and then click **Set up multiple displays**.
4. Click to select a primary display under “**1. Select the displays you want to use.**”
5. Right-click the icons under “**2. Drag the icons to match**” and select **Extend**.

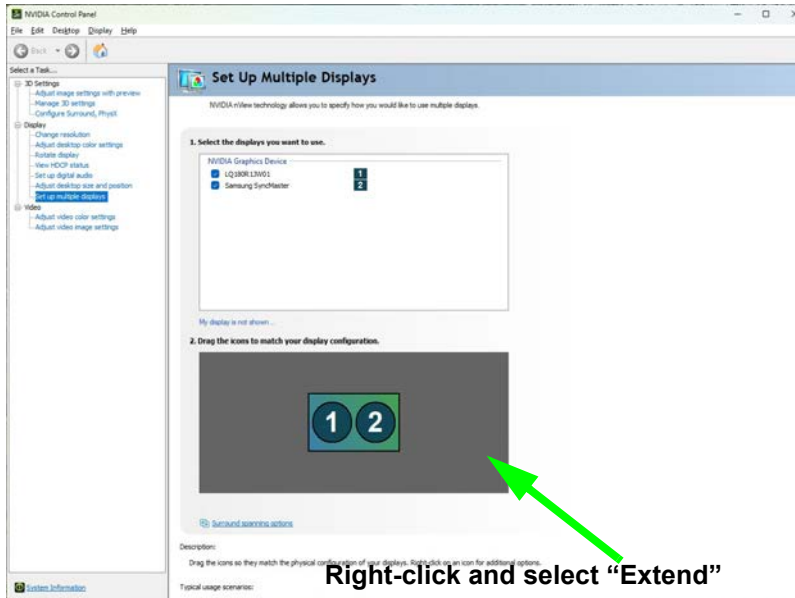

Changing the Primary Display on Extended Displays

If you want to switch the primary display if the displays are extended then right-click the secondary display icon and select “**Make Primary**”. Click **Apply > Yes** to save the change (see over).

Figure B - 40
Extend the Display

Video Driver Controls

6. The Primary display (the main window display) will be denoted by an **asterisk *** in the top right corner of the icon.
7. To change the Primary display **right-click the icon** and select **Make primary**.
8. Click **Apply > Yes** to save any changes.

Figure B - 41
Switch Primary Display

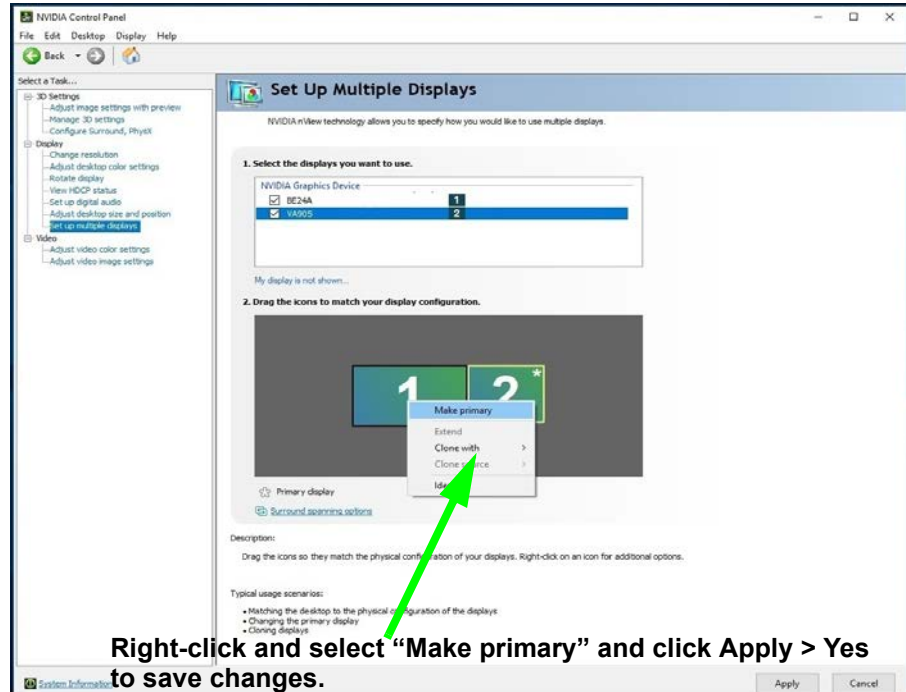

Right-click and select “Make primary” and click Apply > Yes to save changes.

9. You can drag the icons to match the desktop layout you want to use (e.g. you may want to extend the display to the right or left of the primary display).
10. Click **Apply > Yes** to save any further changes.

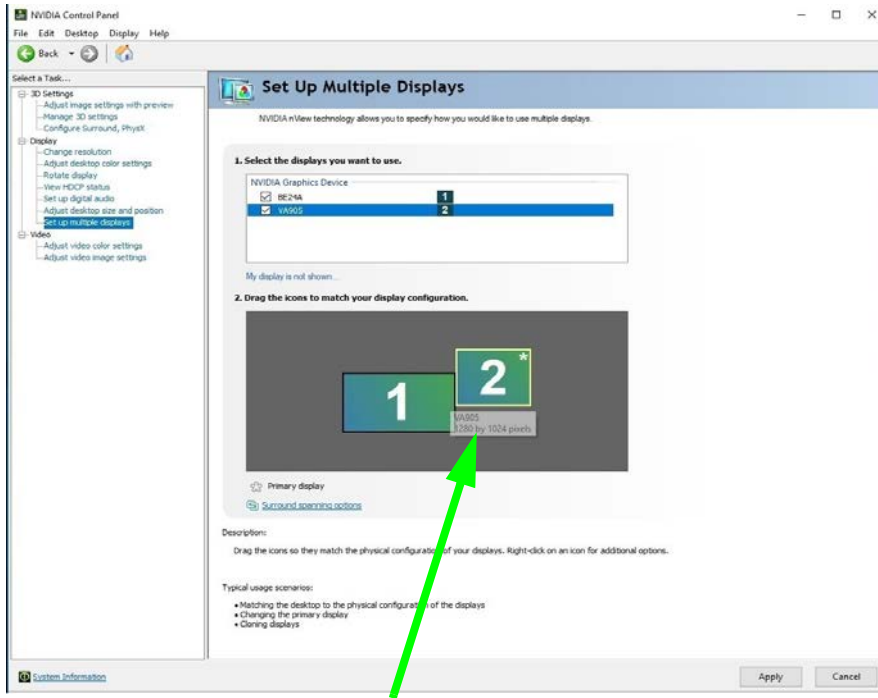

Figure B - 42
Drag Display
Icons

Drag the display icons to match the layout you want to use.

Appendix C: Specifications



Latest Specification Information

The specifications listed in this Appendix are correct at the time of going to press. Certain items (particularly processor types/speeds and CD/DVD device types) may be changed, updated or delayed due to the manufacturer's release schedule. Check with your distributor/supplier for details.

Note that this computer model series may support a range of CPUs and/or video adapters.

To find out which **CPU** is installed on your system go to the **Start** menu and select **Settings**, and then select **System** and click **About**. This will also provide information on the amount of **Installed RAM** etc.

To get information on your system's **video adapter** go to the **Start** menu and select **Settings**, and then select **System** and click **Display > Advanced display settings > Display adapter properties**.

Specifications

Display	<div style="text-align: center;">  <p>SO-DIMM Memory Types</p> <p>All SO-DIMM memory modules installed in the system should be identical (the same size and brand) to prevent unexpected system behavior.</p> <p>To prevent system problems, don't mix SO-DIMM memory module sizes and brands.</p> <p>Note that at least 2 memory modules must be installed in the memory sockets or the system will not function.</p> <p>The system requires either two or four memory modules to be installed. If only two modules are installed, these modules must be paired together in the appropriate sockets e.g. in Slots 1 & 2 or Slots 3 & 4.</p> </div>	2 * Built-In 1W Tweeter Speakers 2 * Built-In 2W Mid Range Speakers 1 * Built-In 4W Subwoofer Speaker Sound Blaster Studio PRO 2
18" / 46.92cm, UHD+ (3840 * 2400), QHD+ (2560 * 1600), 16:10, 5.5mm Thick Backlit Panel		Pointing Device & Keyboard
Memory	Storage	Built-in Click Pad with Microsoft PTP Multi-Gesture and Scrolling Functionality Full Size & Full Color Illuminated LED "Per Key" Keyboard with Numeric Pad
Dual Channel DDR5 Memory Expandable up to 192GB Compatible with 8GB, 16GB, 32GB or 48GB Modules (2 or 4 RAM Modules Only) Four 262 Pin SO-DIMM Sockets, workable only with Two or Four SO-DIMM modules , Supporting up to DDR5 6400MHz (processor dependent) Memory Modules (<i>real operational frequency depends on the processor and memory modules</i>)	Four M.2 SSD 2280, PCIe Gen 4*4 Interface (RAID 0/1/5) OR One Compatible with PCIe Gen 5*4	Interface
	Audio	**One Thunderbolt 5 Port with Power Delivery DC-In **One Thunderbolt 5 Port *Two USB 3.2 Gen 2 Ports (Type A) (including 1 AC/DC Powered USB Port) *Note: The maximum amount of current supplied by standard USB 3.2 ports is 900 mA. **Note: The maximum amount of current supplied by the Thunderbolt port is 5V/3A in AC mode or 5V/1.5A in DC mode. ===== See over
High Definition Audio Interface Built-In Array Microphone		

<p>One HDMI-Out (High-Definition Multimedia Interface) Port (with HDCP) One 2-in-1 Audio Jack (Headphone / Microphone) Two RJ-45 LAN Jacks One DC-In Jack</p>	<h3>Communication</h3>	<h3>Power & Battery</h3>
<h3>Card Reader</h3>	<p>Built-In Killer™ 10/100/1000/2500Mb Base-TX Ethernet LAN</p> <p>Dual Sensor Windows 5M Hello Camera with TNR and SecureBIO and Human Presence Detection</p>	<p>Full Range AC/DC Adapter - AC input 100 - 240V, 50 - 60Hz, DC Output 20V, 16.5A (330 Watts)</p> <p>Embedded 8 Cells Polymer Battery Pack 98WH</p>
<p>Micro SD Push-Push Card Reader</p>	<p>Killer Tri-Band Wi-Fi 7 BE1750x 2*2 WLAN + Bluetooth M.2 2230 Module (Factory Option)</p>	<h3>Security</h3>
<h3>Slot</h3>	<p>Intel® Tri-Band Wi-Fi 7 BE200 2*2 WLAN + Bluetooth M.2 2230 Module (Factory Option)</p>	<p>Security (Kensington® Type) Lock Slot BIOS Password Intel® PTT for systems without TPM Trusted Platform Module 2.0 (Factory Option)</p>
<p>Five M.2 Card Slots:</p> <p>Slot 1 for M.2 2230 WLAN Combo Module with PCIe / USB / CNVI Interfaces (E Key)</p> <p>Slot 2 for SSD M.2 2280 Card with PCIe Gen 4*4 Interface (M Key) OR PCIe Gen 5*4 Interface Compatible (M Key)</p> <p>Slot 3 for SSD M.2 2280 Card with PCIe Gen 4*4 Interface (M Key)</p>	<p>Intel® Dual Band Wi-Fi 6E AX211 2*2 WLAN + Bluetooth M.2 2230 Module (Factory Option)</p>	<h3>Features (For Some Model Designs)</h3>
<p>Slot 4 for SSD M.2 2280 Card with PCIe Gen 4*4 Interface (M Key)</p>	<p>Intel® Dual Band Wi-Fi 6 AX201 2*2 WLAN + Bluetooth M.2 2230 Module (Factory Option)</p>	<p>Metallic Finish Camera Shutter Shipping Mode FlexiCharger NVIDIA® Virtual Reality Ready NVIDIA® G-Sync Technology at Dynamic Display Switch Mode (For some model designs) Killer Double-Shot™ Pro with Killer™ Wireless Module Intel® Dynamic Tuning Technology</p>
<p>Slot 5 for SSD M.2 2280 Card with PCIe Gen 4*4 Interface (M Key)</p>	<h3>Power Management</h3>	
	<p>Supports Wake on USB Supports Wake on LAN (AC Mode Only) Supports Wake on RTC Alarm</p>	



Specifications

X-Rite™ Pantone® Color Calibration Certified (For some model designs)
LED Light Bar Module (**For Model A Computers Only**)

Operating System

Windows® 11 24H2 (64-bit)

Indicators

Power/Suspend, Battery, Storage & Camera

BIOS

One 256Mb SPI Flash ROM
Insyde BIOS

Environmental Spec

Temperature

Operating: 5°C - 35°C

Non-Operating: -20°C - 60°C

Relative Humidity

Operating: 20% - 80%

Non-Operating: 10% - 90%

Dimensions & Weight

402mm (w) * 320mm (d) * 28mm (h)

3.9kg *Barebone System with 98WH Battery

**A barebone system does not include the Storage, RAM, adapter, power cord and factory option modules (weight tolerance within +/- 5%).*