

BaByliss[®] PRO

S T Y L I S T T O O L S



Perfect Curl

BAB2665U

UK Patent and Application Nos. GB2455716; EP2242393; WO2012/080751; GB1210274.5

BABYLISS PRO PERFECT CURL

Effortlessly create long-lasting beautiful curls, with the BaByliss Pro Perfect Curl. Hair is automatically drawn into the ceramic curl chamber where it is softly held and heated from all directions to effortlessly form the curl. Then, simply release. The result is beautiful, free-flowing curls.

FEATURES:

- Ceramic curl chamber for smooth curl creation
- 3 timer settings with audio beep indicator for different curl effects
- 3 heat settings; 190°C, 210°C and 230°C for long lasting results
- Powerful heating system ready to use in seconds with ultra-fast heat recovery
- Curl direction control for either a uniform or natural finish (Right/Left/Auto)
- Suitable for shorter and longer hair lengths
- On/off switch with on indicator light
- Heat ready indicator
- 20min sleep mode function
- Auto shut off
- Salon length swivel cord
- 6 month guarantee

SAFETY CAUTIONS

- This appliance should only be used as described within this instruction booklet. Please retain for reference.

WARNING! Polythene bags over product or packaging may be dangerous. To avoid danger of suffocation, keep wrapper away from babies and children. These bags are

not toys.

WARNING! Do not use this appliance near water contained in basins, bathtubs or other vessels.



- Do not use the appliance in the bathroom.
- Do not immerse the appliance in water or other liquids.
- Always inspect the appliance before use for noticeable signs of damage. Do not use if damaged, or if the appliance has been dropped.
- In the event of damage, contact the Conair Customer Care Line (refer to 'UK After Sales Service' section for further information).
- Do not use the appliance if the lead is damaged. In the event of lead damage, discontinue use immediately. If the lead is damaged it must be replaced by the manufacturer. Return the appliance to the Customer Care Centre (refer to 'UK After Sales Service' section for further information). No repair must be attempted by the consumer.
- Do not leave the appliance unattended when switched on or plugged in.
- Do not place the appliance on any heat sensitive surface whilst in operation.
- In the event of the appliance left switched on, the appliance will automatically shut off after 60 minutes. If you wish to continue using the appliance after this time, simply slide the switch to off position and then slide to the relevant setting to turn the power on.
- Take care to avoid the hot surface of the appliance

coming into direct contact with the skin, in particular the eyes, ears, face and neck.

- This appliance should not be used by adults who's reduced physical, sensory or mental capabilities, or whose lack of experience and knowledge, might cause a hazard, unless they have been correctly instructed to understand the safe use and hazards involved and are adequately supervised.
- Careful adult supervision is required when this appliance is used on or near children. Do not use on very young children.
- This appliance should not be used, cleaned or maintained by children. Keep out of reach of children.
- Always ensure that this appliance is kept out of the reach of children at all times, particularly during use and whilst cooling.
- Allow appliance to cool before storing away.
- After use, do not wrap the lead around the appliance as this may cause damage. Instead, coil loosely by the side of the appliance.
- This appliance complies with the requirements of Directives 2004/108/EC (Electromagnetic Compatibility) and 2006/95/EC (Electrical Safety of Domestic Appliances).

OPERATING FEATURES

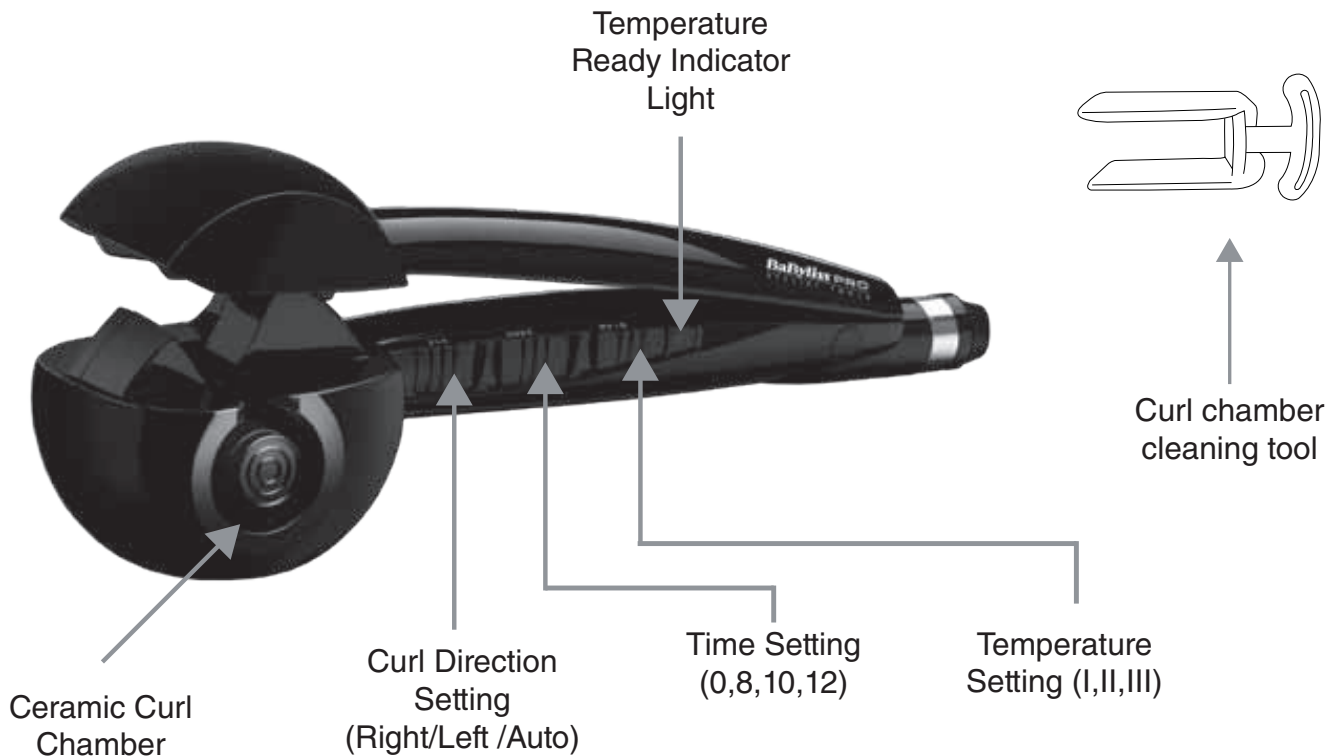

OPERATING INSTRUCTIONS

The Perfect Curl will create many different curl effects in the hair. It is easy to experiment with the different settings to achieve the desired results.

To watch a detailed 'How to Video' on how easy it is to create the Perfect Curl please scan here:



or alternatively visit www.babylisspro.co.uk/perfectcurl

Always ensure that the hair is clean, dry and combed through and that the sections you want to curl are no bigger than 3cm wide. When working with naturally curly or longer length hair, we advise you to use even smaller sections. The type of curl will depend on the temperature selected, and the timer setting which dictates the amount of time the hair is kept inside the curl chamber.

TEMPERATURE SETTINGS

There are 3 temperature settings to select from; 190°C, 210°C and 230°C. We recommend you always start with the lowest temperature setting and increase the level of heat as required.

- Setting I (190°C) - for delicate, fine or coloured hair
- Setting II (210°C) - for normal textured hair
- Setting III (230°C) - for thick or wavy hair

TIME SETTINGS

There are 3 timer settings with audio beep indicator. These different settings will give different curl effects. The longer the time the hair is held inside the curl chamber, the more defined the curl will be. But results will also vary according to hair type. Use the following as a guide.

- Setting 8 (8 seconds = 3 beeps) - for loose waves
- Setting 10 (10 seconds = 4 beeps) - for soft curls
- Setting 12 (12 seconds = 5 beeps) - for more defined curls

Audio off Setting

The automatic-beep indicator can be turned off if not required by sliding the timer switch to '0'.

NOTE: When the '0' setting is selected there will be no beep indicator to advise when to release the styler. Take extra care when using this setting.

CURL DIRECTION SETTING (Right/Left/Auto)

Use the Curl direction control to choose either a uniform or natural finish. Select the curl direction by sliding the switch to either left 'L' or right 'R'.

When styling the left side of the hair, slide the curl direction switch to the left position - 'L'. When styling the right side of the hair, slide the switch to the right position - 'R'. This ensures that the curl sits towards the face on both sides of the head and will give a more uniform style.

For a more natural look then select the auto setting 'A'. This will alternate the direction after each curl.

INSTRUCTIONS FOR USE

- Plug the styler into a suitable mains socket.
- Slide the temperature switch to the required heat setting.
- The styler is ready for use when the on indicator light has stopped flashing.
- There are 3 timer settings, choose the required setting for the hair type. Alternatively, switch the audio off to '0'.
- Select the curl direction by sliding the control to either position 'L', 'R' or 'A'
- Ensure hair is clean, dry and combed through.
- Separate a section of hair that is no bigger than 3cm (Diagram A). When working with naturally curly or longer length hair, we advise you to use even smaller sections.

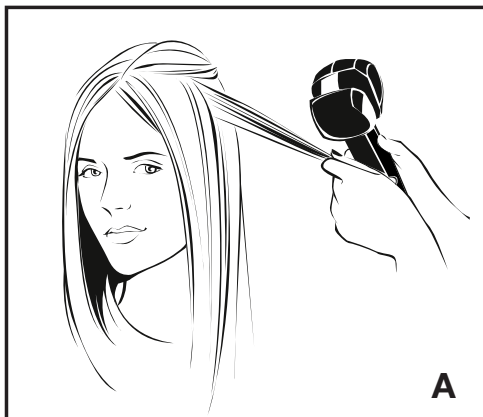

- Please note the styler must be positioned into the hair with the open part of the curl chamber facing towards the head. (Diagram B).

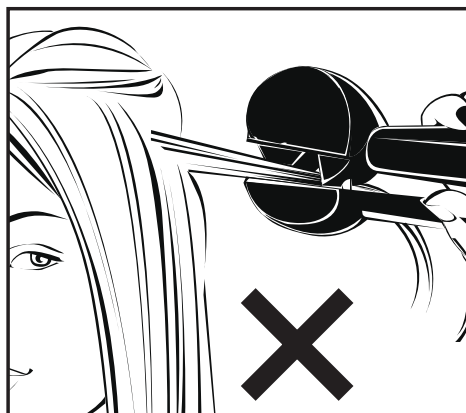
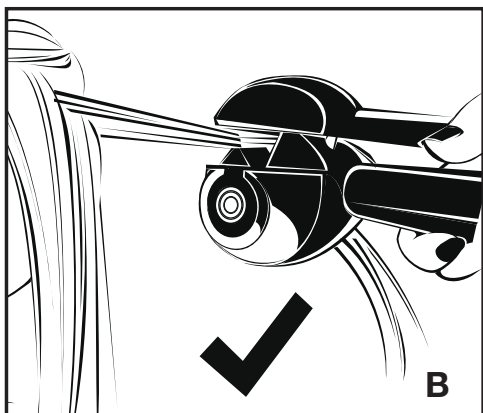

- Position the styler where you want the curl to start. The hair section must be held straight, and placed neatly through the centre of the styler. (Diagram C & D).

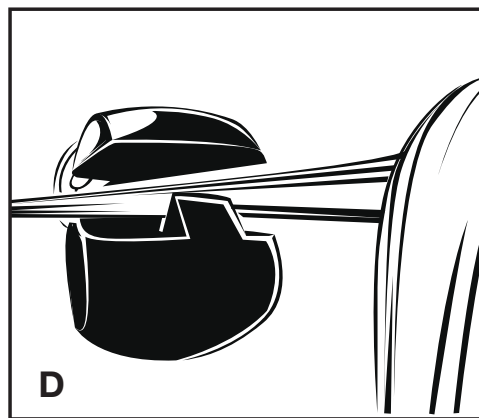
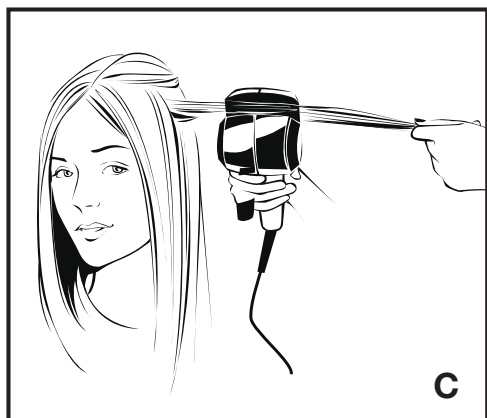

- Once the hair is in place, let go of the hair section and close the handle to allow the hair to be automatically taken into the curl chamber. (Diagram E).



NOTE: If you continue to hold the hair section after closing the handle then the Perfect Curl will stop and beep to indicate that you must release the tension on the hair. If you have taken too much hair, or hair is not neatly going through the centre of the appliance, the Perfect Curl will again stop and beep to indicate a problem. This safety feature ensures that there will be no tangles.

- The hair is automatically drawn into the ceramic curl chamber where it is softly held and heated from all directions to effortlessly form the curl.
- If using the timer setting, the automatic beep indicator will start

as soon as the handles are closed together. There will be a series of individual beeps. Hold the styler still with the handles closed together until the end of the individual beeps. There will then be four quick beeps in succession. This indicates that the time is up and you can remove the styler from the hair. **NOTE:** When the audio off '0' setting is selected there will be no beep indicator. There will just be a warning beep at 15 seconds.

- It is very important that you release the handles fully, and then gently pull the styler away from the head to free the hair and reveal the curl (Diagram F). **NOTE:** Always release the handles first to let the curl free; if you pull away before you open the handles, the curl will be straightened out.

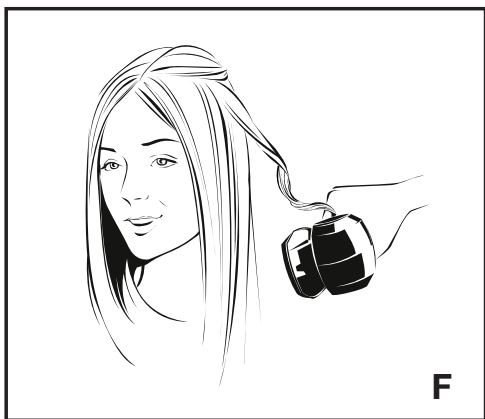

- To allow the curl to set, do not comb or brush the hair until it cools.
- Repeat around the head until you have the amount of curls desired.

SLEEP MODE

This appliance has an automatic sleep mode feature. If the appliance is not used for more than 20 minutes the temperature will automatically drop down to 150°C. If you wish to continue using the appliance after this time, simply close then release the handles and it will return to the temperature setting you were using it on.

AUTO SHUT OFF

This appliance has an automatic shut off feature for added safety. If the appliance is switched on for more than 60 minutes continuously, it will

automatically switch off. If you wish to continue using the appliance after this time, simply slide the switch to off position and then slide to the relevant setting to turn the power on.

CLEANING & MAINTENANCE

It is very important that you use the cleaning tool included with your Perfect Curl to regularly clean the curl chamber. This will prevent a build-up of product to ensure the curls produced are always perfectly formed.

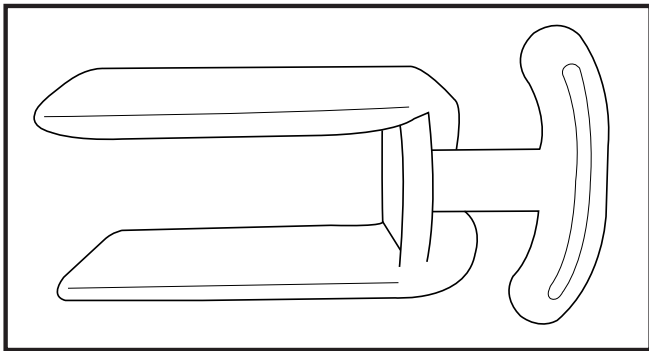

- Ensure the appliance is switched off, unplugged and cool.
- Lightly damp the cleaning tool with warm water and mild detergent or soap.
- Insert the tool fully into the curl chamber cavity as per the diagrams below.

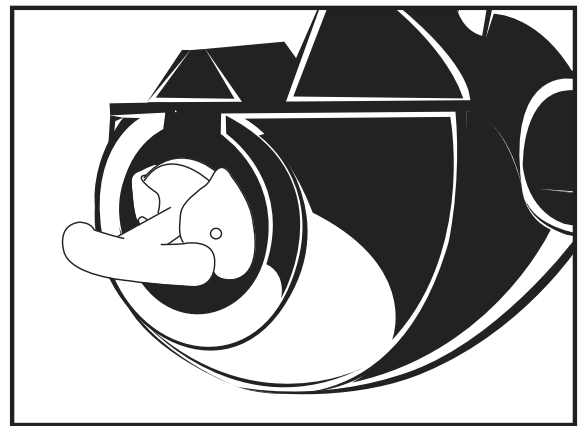
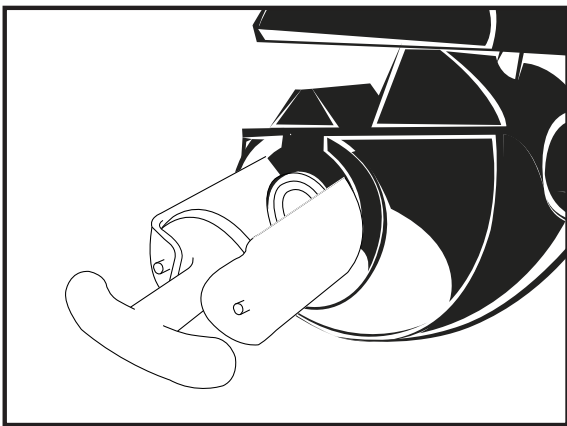

- Rotate the tool around the curl chamber to remove any build-up of product.

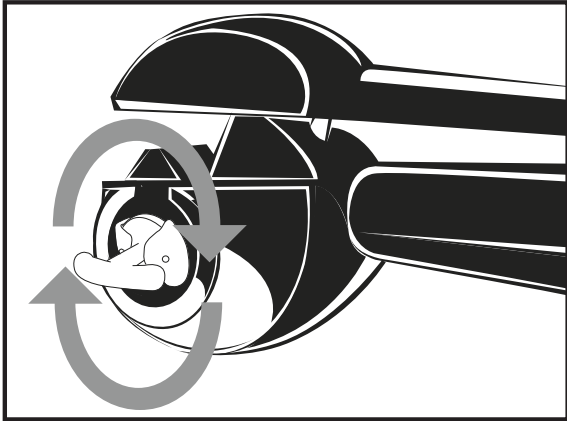

- Ensure the appliance has dried thoroughly before re-using.
- The cleaning tool can be used numerous times; just remove the felt pads, rinse them in warm, soapy water and leave to dry before using again.

IMPORTANT: Do not immerse the appliance in water or other liquids. To help keep your styler in the best possible condition follow the steps below:

- Do not wrap the lead around the appliance; instead coil the lead loosely by the side of the appliance.
- Do not use the appliance at a stretch from the power point.
- Always unplug after use.

UK GUARANTEE

This BaByliss PRO appliance is guaranteed for salon use for 6 months. This guarantee covers defects under normal use from date of purchase and ceases to be valid in the event of alteration or repair by unauthorised persons. If the appliance does not perform satisfactorily due to defects in materials or manufacture, it will be repaired or replaced through Conair UK After Sales Service. The Conair Group Ltd reserves the right to amend terms and specifications without prior notice.

This guarantee in no way affects your statutory rights.

SAFE DISPOSAL



The  symbol on the product or on its packaging indicates that this product may not be treated as household waste. Instead it should be handed to an appropriate collection point for the recycling of Electrical and Electronic equipment. By ensuring this product is disposed of correctly, you will help prevent potential negative consequences for the environment and human health, which could otherwise be caused by inappropriate waste handling of this product. For more detailed information about the recycling of this product, please contact your local council office or your household waste disposal service.

UK AFTER SALES SERVICE

For further advice on using the appliance, contact the Conair Customer Care Line on 0870 5 133191 (09:00 to 17:00 Monday to Friday) or email your enquiry to ukinfo@conair.com.

If you should need to return your appliance to us please send it to the following address:

Customer Care Centre,
Conair Logistics
Unit 4
Revolution Park
Buckshaw Avenue
Buckshaw Village
Chorley
PR7 7DW

Please enclose your name and address, together with a copy of proof of purchase and details of the fault.

UK WIRING INSTRUCTIONS

The wires in the mains lead are coloured in accordance with the following code:

BLUE = NEUTRAL

BROWN = LIVE

- The wire which is coloured BLUE must be connected to the terminal which is marked with the letter N.
- The wire which is coloured BROWN must be connected to the terminal which is marked with the letter L.
- Neither core should be connected to the earth terminal of a three pin plug marked with the letter E or \perp .

This appliance comes fitted with a British Standard 13 amp type plug and a 5 amp fuse. It is important to always use a 5 amp fuse, should its replacement be required. If any other type of plug is used, a 5 amp fuse must be fitted at the distribution board.

