

Always there to help you

Register your product and get support at
www.philips.com/support



SHB5800



User manual

PHILIPS

Contents

1	Important safety instructions	2
	Hearing Safety	2
	General information	2
	Compliance with EMF	2

2	Your wireless in-ear headset	3
	What's in the box	3
	Other devices	3
	Overview of your wireless headset	3

3	Get started	5
	Charge your headset	5

4	Pair the headset with your mobile phone	6
	Manual pairing	6
	NFC pairing	6

5	Use your headset	7
	Connect the headset to a Bluetooth device	7
	Manage your calls and music	7

6	Technical data	8
----------	-----------------------	----------

7	Notice	9
	Declaration of conformity	9
	Disposal of your old product and battery	9
	Trademarks	10

8	Frequently asked questions	11
----------	-----------------------------------	-----------

1 Important safety instructions

Hearing Safety



Danger

- To avoid hearing damage, limit the time you use the headset at high volume and set the volume to a safe level. The louder the volume, the shorter the safe listening time is.

Be sure to observe the following guidelines when using your headset.

- Listen at reasonable volumes for reasonable periods of time.
- Be careful not to adjust the volume continuously upwards as your hearing adapts.
- Do not turn up the volume so high that you can't hear what's around you.
- You should use caution or temporarily discontinue use in potentially hazardous situations.
- Excessive sound pressure from earphones and headset can cause hearing loss.
- Using the headset with both ears covered while driving is not recommended and may be illegal in some areas while driving.
- For your safety, avoid distractions from music or phone calls while in traffic or other potentially dangerous environments.

General information

To avoid damage or malfunction:



Caution

- Do not expose the headset to excessive heat.
- Do not drop your headset.
- Headset shall not be exposed to dripping or splashing.
- Do not allow your headset to be submerged in water.
- Do not use any cleaning agents containing alcohol, ammonia, benzene, or abrasives.
- If cleaning is required use a soft cloth, if necessary dampened with a minimum amount of water or diluted mild soap, to clean the product.
- The integrated battery shall not be exposed to excessive heat such as sunshine, fire or the like.

About operating and storage temperatures and humidity

- Operate or store in a place where temperature is between -15°C (5°F) and 55°C (131°F) (up to 90% relative humidity).
- Battery life may be shorter in high or low temperature conditions.

Compliance with EMF

This product complies with all applicable standards and regulations regarding exposure to electromagnetic fields.

2 Your wireless in-ear headset

Congratulations on your purchase, and welcome to Philips! To fully benefit from the support that Philips offers, register your product at www.philips.com/welcome.

With this Philips wireless in-ear headset, you can:

- enjoy convenient wireless handsfree calls;
- enjoy and control wireless music;
- switch between calls and music.

What's in the box

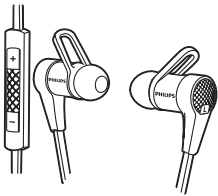

Philips Bluetooth wireless headset SHB5800

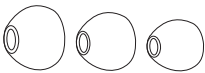

Replaceable rubber ear caps

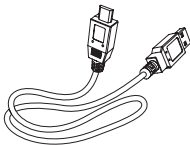

USB charging cable (for charging only)



Fit loop × 2 sets



Quick start guide

Other devices

A mobile phone or device (e.g. notebook, PDA, Bluetooth adapters, MP3 players etc) which supports Bluetooth and is compatible to the headset.

Overview of your wireless headset

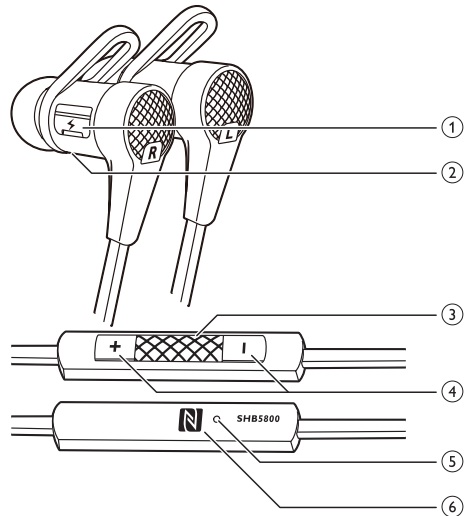

- ① Micro USB charging slot
- ② LED light
- ③ On/off, call/music control button
- ④ Volume/Track control button
- ⑤ Microphone
- ⑥ NFC detection area

3 Get started

Charge your headset



Note

- Before you use your headset for the first time, charge the battery for 5 hours for optimum battery capacity and lifetime.
- Use only the original USB charging cable to avoid any damage.
- Finish your call before charging the headset, as connecting the headset for charging will power the headset off.
- You can operate the headset normally during charging.

Connect the supplied USB charging cable to:

- the micro USB charging slot on the headset and;
 - the charger/USB port of a computer.
- ↳ LED turns white during charging and turns off when the headset is fully charged.



Tip

- Normally, a full charge takes 2.5 hours.

4 Pair the headset with your mobile phone

Before you use the headset with your mobile phone for the first time, pair it with a mobile phone. A successful pairing establishes a unique encrypted link between the headset and mobile phone. The headset stores the last 4 devices in the memory. If you try to pair more than 4 devices, the earliest paired device is replaced by the new one.

There are two ways to pair your headset with your mobile phone:

- Manual pairing
- NFC pairing

Manual pairing

- 1 Make sure that the headset is fully charged and turned off.
- 2 Press and hold the on/off button until the blue and white LED flashes alternately.
↳ The headset remains in pairing mode for 5 minutes.
- 3 Make sure that the mobile phone is turned on and its Bluetooth feature is activated.
- 4 Pair the headset with the mobile phone. For detailed information, refer to the user manual of your mobile phone.

NFC pairing

- 1 Make sure you turn on the NFC function on your phone and your phone's screen remains active.

- 2 Place your phone over the NFC detection area (see 'Overview of your wireless headset' on page 3).
- 3 Follow the pairing instructions of your phone. Enter the password "0000" (4 zeros) if prompted.

Note

- Make sure your mobile phone has the NFC feature available and switched on.
- Make sure your mobile phone is not in standby mode.
- Pairing with NFC is only suitable for Android mobile operating system 4.2 or above.
- Refer to the user manual of your mobile phone to identify its NFC detection area.

The following example shows you how to pair the headset with your mobile phone.

- 1 Activate the Bluetooth feature of your mobile phone, select Philips SHB5800.
- 2 Enter the headset password "0000" (4 zeros) if prompted. For those mobile phones featuring Bluetooth 2.1+EDR or higher, no need to enter a password.

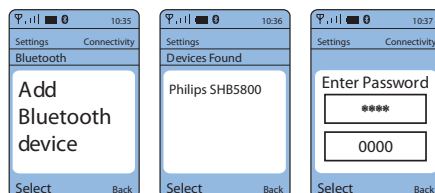

5 Use your headset

Connect the headset to a Bluetooth device

- 1 Turn on your mobile phone/Bluetooth device.
- 2 Press and hold the on/off button to turn the headset on.
 - ↳ The blue LED flashes.
 - ↳ The headset is reconnected to the last connected mobile phone/Bluetooth device automatically. If the last one is not available, the headset tries to reconnect to the second last connected device.

Tip

- If you turn on the mobile phone/Bluetooth device or activate the Bluetooth feature after turning on the headset, you have to reconnect the headset and mobile phone/Bluetooth device manually.

Note

- If the headset fails to connect to any Bluetooth device within range in 5 minutes, it will switch off automatically to save the battery life.

Manage your calls and music

On/off, call/music control button

Task	Operation	Sound or LED indicator
Turn the headset on.	Press and hold for 2 seconds.	Power on tone

Turn the headset off.	Press and hold for 4 seconds.	Power off tone
Play or pause music.	Press once.	N/A
Pick up/hang up a call.	Press once.	1 short beep
Reject an incoming call.	Press and hold	1 short beep
Redial the last number.	Press twice.	2 short beeps
Switch caller during a call.	Press twice	1 short beep

Volume/Track control button

Adjust volume.	Press once	N/A
Skip forward.	Press and hold	N/A
Skip backward.	Press and hold	N/A

Other headset indicator status

Headset status	Indicator
The headset is connected to a Bluetooth device, while the headset in standby mode or while you are listening to music.	The blue LED flashes for every 6 seconds.
The headset is ready for pairing.	The LED flashes blue and white alternately.
The headset is on but not connected to a Bluetooth device.	The blue LED flashes quickly.
There is an incoming call.	The blue LED flashes once per second.
The battery level is low.	The white LED flashes.
The battery is fully charged.	The white LED is off.

6 Technical data

- Up to 5.5 hours of music time or 6 hours of talk time
- Up to 150 hours of standby time
- Normal time for a full charge: 2.5 hours
- Rechargeable Lithium-ion battery (85 mAh)
- Bluetooth 3.0, Bluetooth mono support (Headset Profile - HSP, Hands-Free Profile - HFP), Bluetooth stereo supported (Advanced Audio Distribution Profile - A2DP; Audio Video Remote Control Profile - AVRCP)
- Operating range: Up to 10 meters (33 feet)
- Digital echo & noise reduction
- Auto power off



Note

- Specifications are subject to change without notice.

7 Notice

Declaration of conformity

Hereby, WOOX Innovations declares that this product is in compliance with the essential requirements and other relevant provisions of Directive 1999/5/EC. You can find the Declaration of Conformity on www.p4c.philips.com.

This product has been designed, tested and manufactured according the European R&TTE directive 1999/5/EC.

Disposal of your old product and battery



Your product is designed and manufactured with high quality materials and components, which can be recycled and reused.



This symbol on a product means that the product is covered by European Directive 2012/19/EU.



This symbol means that the product contains a built-in rechargeable battery covered by European Directive 2013/56/EU which cannot be disposed of with normal household waste. We strongly advise you to take your product to an official collection point or a Philips service centre to have a professional remove the rechargeable battery. Inform yourself about the local separate collection system for electrical and electronic

products and rechargeable batteries. Follow local rules and never dispose of the product and rechargeable batteries with normal household waste. Correct disposal of old products and rechargeable batteries helps prevent negative consequences for the environment and human health.

Remove the integrated battery

Note

- Make sure the headset is disconnected from the USB charging cable before removing the battery.

If there is no collection/recycling system for electronic products in your country, you can protect the environment by removing and recycling the battery before disposing of the headset.

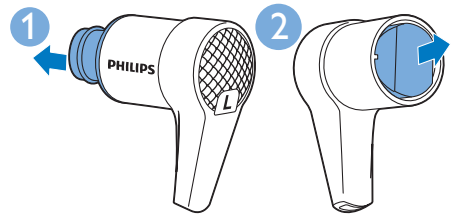

Environmental information

All unnecessary packaging has been omitted. We have tried to make the packaging easy to separate into three materials: cardboard (box), polystyrene foam (buffer) and polyethylene (bags, protective foam sheet.)

Your system consists of materials which can be recycled and reused if disassembled by a specialized company. Please observe the local regulations regarding the disposal of packaging materials, exhausted batteries and old equipment.

Trademarks

Bluetooth

The Bluetooth word mark and logos are owned by the Bluetooth SIG, Inc. and any use of such marks by WOOX Innovations Limited is under license.

8 Frequently asked questions

My Bluetooth headset does not switch on.

The battery level is low. Charge the headset.

I cannot pair my Bluetooth headset with a mobile phone.

The Bluetooth is disabled. Enable the Bluetooth feature on your mobile phone and turn on the mobile phone before you turn on the headset.

Pairing does not work.

Make sure the headset is in pairing mode.

- Follow the steps described in this user manual (see 'Pair the headset with your mobile phone' on page 6).
- Make sure that the LED light flashes blue and white alternately before you release the on/off button. Do not stop holding the button if you see the blue LED only.

The mobile phone cannot find the headset.

- The headset may be connected to a previously paired device. Turn off the connected device or move it out of range.
- Pairing may have been reset or the headset has been previously paired with another device. Pair the headset with the mobile phone again as described in the user manual (see 'Pair the headset with your mobile phone' on page 6).

My Bluetooth headset is connected to a Bluetooth stereo enabled mobile phone, but music only plays on the mobile phone speaker.

Refer to the user manual of your mobile phone. Select to listen to music through the headset.

The audio quality is poor and crackling noise can be heard.

The Bluetooth device is out of range. Reduce the distance between your headset and

Bluetooth device, or remove obstacles between them.

The audio quality is poor when streaming from the mobile phone is very slow, or audio streaming does not work at all.

Make sure your mobile phone not only supports (mono) HSP/HFP but also supports A2DP (see 'Technical data' on page 8).

I hear but cannot control music on my Bluetooth device (e.g. play/pause/skip forward/backward).

Make sure the Bluetooth audio source supports AVRCP (see 'Technical data' on page 8).

Are the Bluetooth headsets sweat/water proof?

The Bluetooth headsets are sweat proof to a degree of IPX2, and are not designed as water-proof at audio output areas. Do not wash the headsets by running water; immerse in water or use them under water.

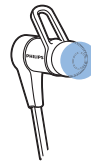

For further support, visit www.philips.com/support.



2014 © WOOX Innovations Limited. All rights reserved.

Philips and the Philips' Shield Emblem are registered trademarks of Koninklijke Philips N.V. and are used by WOOX Innovations Limited under license from Koninklijke Philips N.V.

CE 0890

UM_SHB5800_00_EN_V2.0
wk1436

