

# DENON<sup>®</sup>

## RCD-M41

CD RECEIVER

# Owner's Manual

You can print more than one page of a PDF onto a single sheet of paper.

[Front panel](#)[Display](#)[Rear panel](#)[Remote](#)[Index](#)

<b>Accessories</b>	<b>5</b>
Inserting the batteries	6
Operating range of the remote control unit	6
<b>Features</b>	<b>7</b>
<b>Part names and functions</b>	<b>8</b>
Front panel	8
Display	11
Rear panel	12
Remote control unit	14

## Connections

<b>Speaker connection</b>	<b>18</b>
Connecting the speaker cables	18
Connecting the subwoofer	19
Connecting speakers	19
<b>Connecting an analog device</b>	<b>20</b>
<b>Connecting a digital device</b>	<b>20</b>
<b>Connecting an FM/AM antenna</b>	<b>21</b>
<b>Connecting the power cord</b>	<b>23</b>

## Playback

<b>Basic operation</b>	<b>25</b>
Turning the power on	25
Switching the power to standby	25
Selecting the input source	26
Adjusting the volume	26
Turning off the sound temporarily (Muting)	26
<b>Playing CDs</b>	<b>27</b>
Playing CDs	27
Playing tracks in a specific order (Program playback)	28
<b>Playing DATA CDs</b>	<b>29</b>
Playing files	30
<b>Listening to FM/AM broadcasts</b>	<b>31</b>
Listening to FM/AM broadcasts	31
Automatically presetting FM stations (Auto Preset)	32
Presetting FM/AM stations manually	33
Listening to preset stations	34
Setting the preset channels and changing the received frequency on the main unit	34



<b>Listening to music on a Bluetooth device</b>	<b>35</b>
Playing music from Bluetooth device	36
Pairing with other Bluetooth devices	37
Reconnecting to this unit from a Bluetooth device	38
Turning the Bluetooth function off for high sound performance playback	38
<b>Listening to DIGITAL IN</b>	<b>39</b>
<b>Listening to ANALOG IN</b>	<b>40</b>
<b>Convenience functions</b>	<b>41</b>
Adjusting the tone	42
Sleep timer function	43
Checking the current time	43
Switching the display's brightness	44

## Settings

<b>Menu map</b>	<b>45</b>
Menu operation	46
CLOCK SETUP	47
ALARM SETUP	47
ALARM ON/OFF	48
H/P AMP GAIN	49
SPK OPTIMISE	49
AUTO STANDBY	49
CD AUTO PLAY	50
CLOCK MODE	50



## Tips

---

Tips	52
Troubleshooting	53
<b>Resetting factory settings</b>	<b>61</b>

## Appendix

---

Playing back DATA CDs	62
DIGITAL IN	63
Playing back Bluetooth devices	63
About Discs	64
Last function memory	66
Explanation of terms	67
Trademark information	69
Specifications	70
Index	74









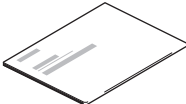
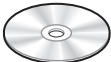

Thank you for purchasing this Denon product.

To ensure proper operation, please read this owner's manual carefully before using the product.

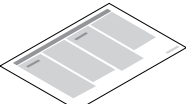
After reading this manual, be sure to keep it for future reference.

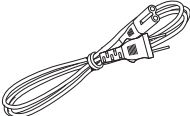
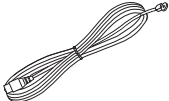
## Accessories

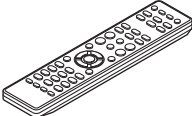
Check that the following parts are supplied with the product.

 Quick Start Guide	 CD-ROM (Owner's Manual)	 Safety Instructions	 Notes on radio	 Warranty (for North America model only)
 Power cord	 FM indoor antenna	 AM loop antenna	 Remote control unit (RC-1214)	 R03/AAA batteries



## Inserting the batteries

- 1 Remove the rear lid in the direction of the arrow and remove it.

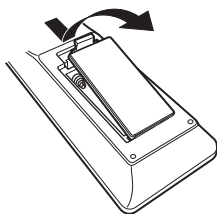

- 2 Insert two batteries correctly into the battery compartment as indicated.

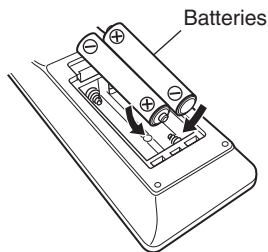

- 3 Put the rear cover back on.

### NOTE

- To prevent damage or leakage of battery fluid:
  - Do not use a new battery together with an old one.
  - Do not use two different types of batteries.
- Remove the batteries from the remote control unit if it will not be in use for long periods.
- If the battery fluid should leak, carefully wipe the fluid off the inside of the battery compartment and insert new batteries.

## Operating range of the remote control unit

Point the remote control unit at the remote sensor when operating it.

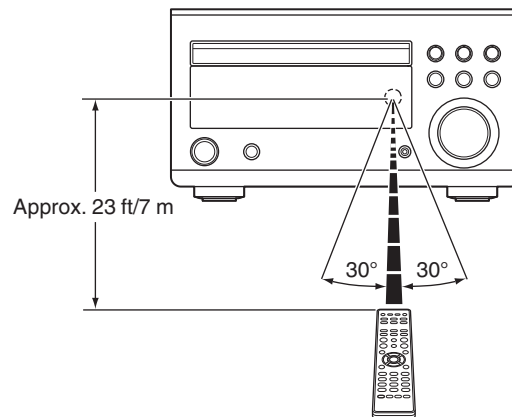

# Features

- **High quality amplifier stressing sound quality**

Equipped with a 30 W + 30 W (6 Ω/ohms) high-quality amplifier circuits.

- **Weight and Dramatic sound**

The board and circuit configuration has been redesigned to achieve lower impedance. Since stable current is supplied to the power amp and other sections, it is possible to realize as much as 30 W of power.

- **Simple & Straight circuit design for sound purity and free of coloration**

Denon's popular M series gives you high sound quality based on the simple & straight concept. Circuitry is uncomplicated, signal paths are short, and all adverse influences on sound quality have been minimized.

- **Auto standby mode**

This unit also provides the Auto standby mode, where it goes into the standby state when there is no operation for 15 minutes.

- **Low standby power consumption**

Designed with the environment in mind, the unit consumes just 0.3 W while in standby mode.

- **Remote control unit**

This unit is shipped with a remote control unit that has large buttons for frequently used functions, allowing you to quickly find the desired function.

- **High quality headphone Amp with Amp gain control**

This unit is equipped with a high-quality headphone amplifier on which the gain can be adjusted. A variety of headphones are supported.

- **2 digital (optical) inputs for TV or digital gear**

You can connect audio from a TV or a media player digitally to enjoy impressive, high-quality sound.

- **Wireless connection with Bluetooth enabled devices (📖 p. 38)**

You can connect Bluetooth enabled devices such as smartphones and tablets with this unit to listen to music while browsing email and Web sites in the Internet away from this unit. In addition, this unit supports high quality audio codecs, AAC, to enjoy music and games with a powerful sound.

- **Bluetooth OFF mode for highest sound performance**

The Bluetooth OFF mode is used to turn off the Bluetooth function, as this function is a source of noise that affects sound quality. Suppressing this noise enables high sound performance playback.



## Part names and functions

### Front panel

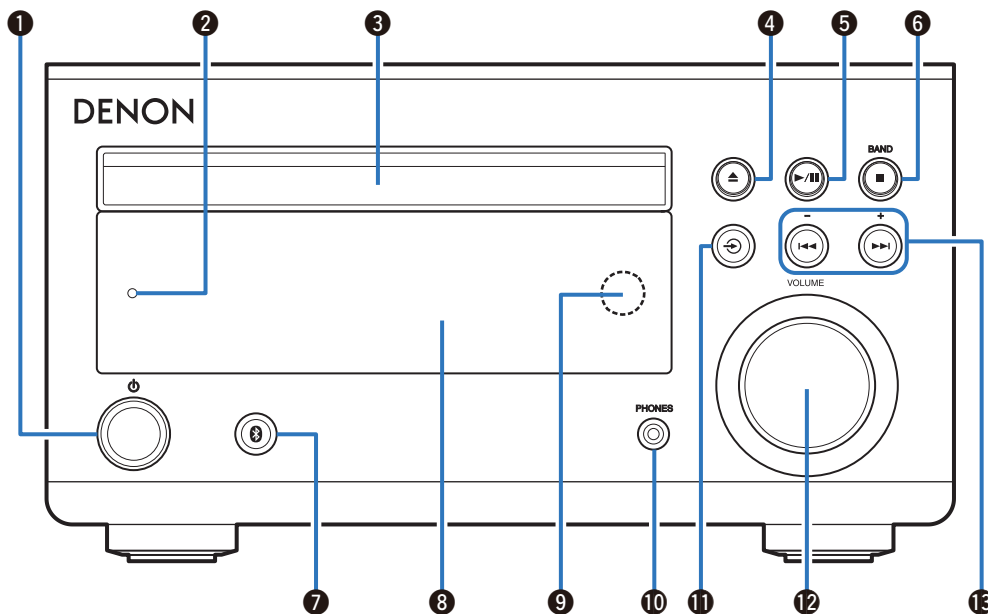

For details, see the next page.



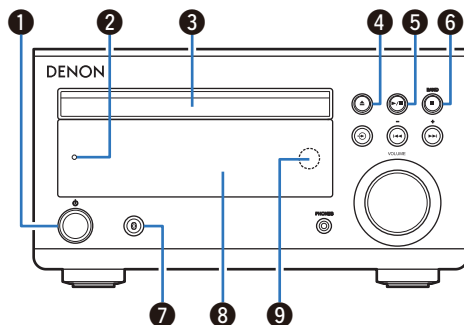

### 1 Power operation button (⏻)

Turns power to this unit on and off (standby). (📖 p. 25)



- When "CLOCK MODE" is turned on, this button switches between normal mode and Clock mode. (📖 p. 50)

### 2 Power indicator

This is lit as follows according to the power status:

- Power on : Green
- Normal standby : Off
- Bluetooth standby : Red (📖 p. 38)
- Alarm standby: Orange (📖 p. 47)

### 3 Disc tray

Used to insert a disc. (📖 p. 27)

### 4 Disc tray open/close button (⏏)

Opens and closes the disc tray.

### 5 Play/Pause button (▶/⏸)

Plays the track/Pauses the track.

### 6 Stop button (■)

Stops playback.

### BAND button

This switches between FM and AM, when you use the tuner.

### 7 Bluetooth button (📶)

This switches the input to Bluetooth. This is also pressed during the pairing operation. (📖 p. 35)

### 8 Display

This displays various pieces of information. (📖 p. 11)

### 9 Remote control sensor

This receives signals from the remote control unit. (📖 p. 6)



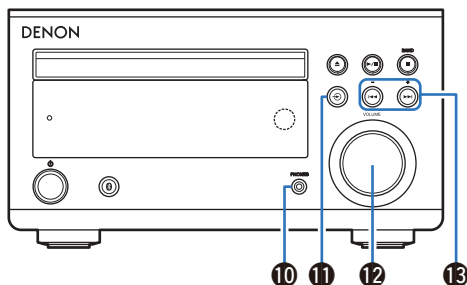

#### 10 Headphones jack (PHONES)

Used to connect headphones.

When the headphones are plugged into this jack, audio will no longer be output from the connected speakers.

#### NOTE

- To prevent hearing loss, do not raise the volume level excessively when using headphones.

#### 11 Source button (↻)

This select the input source. (☞ p. 26)

#### 12 VOLUME knob

This adjusts the volume level. (☞ p. 26)

#### 13 Reverse-skip/Forward-skip buttons (⏮, ⏭)

This skips to the start of the track.

#### Preset/Tuning buttons (-, +)

These select FM broadcast and AM broadcast. (☞ p. 31)

## Display

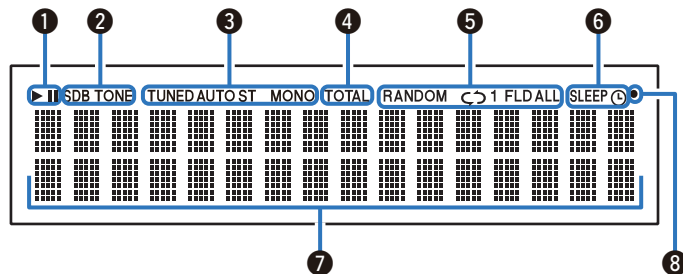

### 1 Playback mode indicators

▶ : Lights up during playback.

⏸ : Lights up during pause.

### 2 Tone indicators

**SDB:** Lights up when the super dynamic bass function is set to "ON".

**TONE:** Lights up when the tone (BASS/TREBLE) is being adjusted.

### 3 Tuner reception mode indicators

These light up according to the reception conditions when the input source is set to tuner.

**TUNED:** Lights up when the broadcast is properly tuned in.

**AUTO:** Lights up when the input source is "FM AUTO".

**ST:** Lights up when receiving FM stereo broadcasts.

**MONO:** Lights up when receiving FM monaural broadcasts.

### 4 TOTAL indicator

Lights up when the total number of tracks and total time of the CD are displayed.

### 5 Play mode indicators

These light according to the play mode settings.

### 6 Timer operation indicators

**SLEEP:** Lights up when the sleep timer is on.

⌚: Lights up when the timer playback is on.

### 7 Information display

Various information is displayed here.

### 8 Remote control signal reception indicator

Lights up when a signal is received from the remote control.

## Rear panel

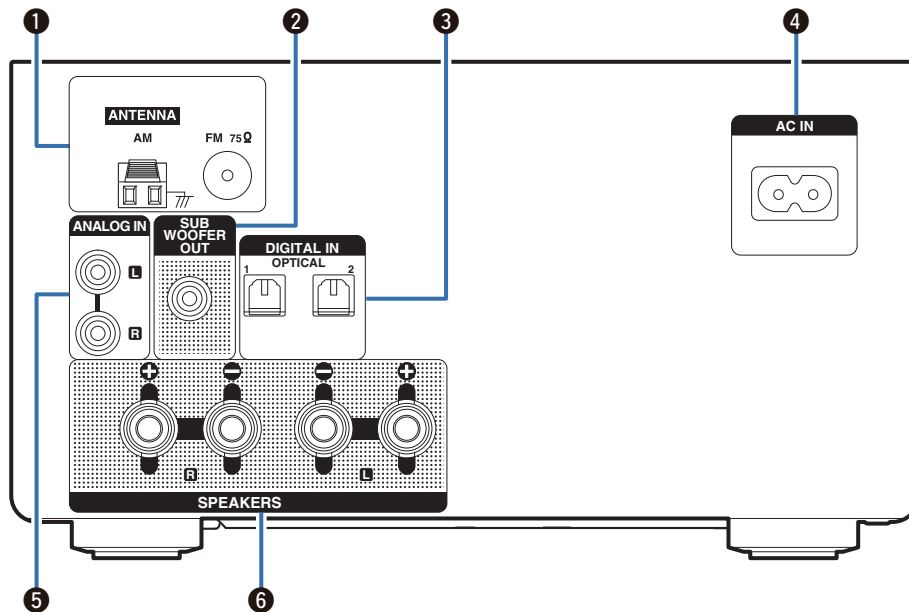

For details, see the next page.

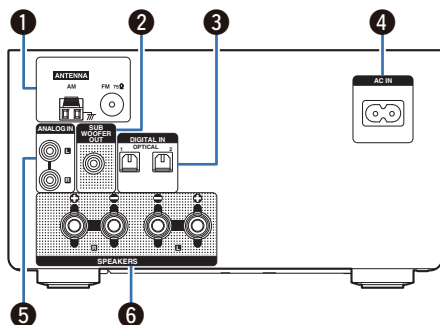

- 1 Antenna terminals (ANTENNA)**  
Used to connect FM antennas and AM loop antennas. (👉 p. 21)
- 2 Subwoofer connector (SUBWOOFER OUT)**  
Used to connect a subwoofer with a built-in amplifier. (👉 p. 19)
- 3 Digital audio connectors (DIGITAL IN)**  
Used to connect devices equipped with digital audio connectors. (👉 p. 20)
- 4 AC inlet (AC IN)**  
Used to connect the supplied power cord. (👉 p. 23)
- 5 Analog audio connectors (ANALOG IN)**  
Used to connect devices equipped with analog audio connectors. (👉 p. 20)
- 6 Speaker terminals (SPEAKERS)**  
Used to connect speakers. (👉 p. 18)

## Remote control unit

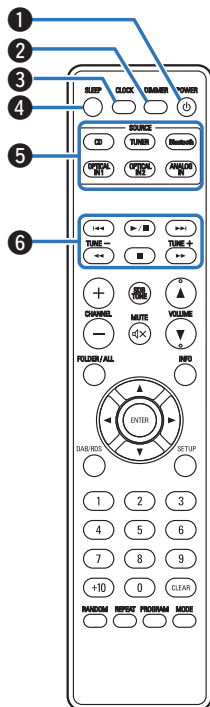

- 1 POWER button (⏻)**  
This turns the power on/standby. (👉 p. 25)
- 2 DIMMER button**  
Adjust the display brightness of this unit. (👉 p. 44)
- 3 CLOCK button**  
The current time appear on the unit. (👉 p. 43)
- 4 SLEEP button**  
This sets the sleep timer. (👉 p. 43)
- 5 Input source select buttons**  
These select the input source. (👉 p. 26)
- 6 System buttons**  
These perform playback related operations.  
**Tuning buttons (TUNE +, -)**  
These select FM broadcast and AM broadcast. (👉 p. 31)

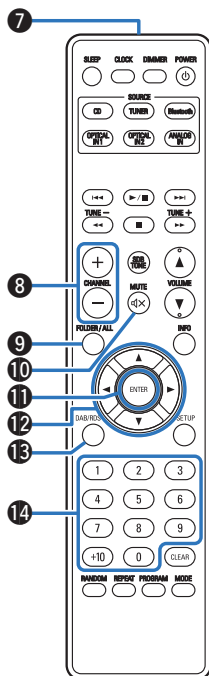

- 7 Signal transmitter**  
This transmits signals from the remote control unit. (👉 p. 6)
- 8 CHANNEL buttons (+, -)**  
This switches between preset channels. (👉 p. 31)
- 9 FOLDER/ALL button**  
This switches the playback range on a data CD. (👉 p. 29)
- 10 MUTE button (🔇)**  
This mutes the output audio. (👉 p. 26)
- 11 ENTER button**  
This determines the selection.
- 12 Cursor buttons (⬆️⬇️⬇️⬆️)**  
These select items.
- 13 DAB/RDS button**  
This button on this unit cannot be used.
- 14 Number buttons (0 – 9, +10)**  
These enter numbers into the unit.

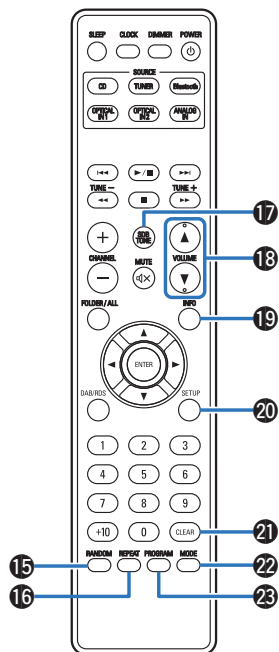

- 15 **RANDOM button**  
Switches the random playback.
- 16 **REPEAT button**  
Switches to the repeat playback.
- 17 **SDB/TONE button**  
Adjusting the tone. (☞ p. 42)
- 18 **VOLUME buttons (▲▼)**  
These adjust the volume level. (☞ p. 26)
- 19 **Information button (INFO)**  
This switches the track information shown in the display during playback.
- 20 **SETUP button**  
The setting menu is displayed on the display. (☞ p. 46)
- 21 **CLEAR button**  
This cancels the settings.
- 22 **MODE button**  
This switches the operation mode for the FM tuning. (☞ p. 31)
- 23 **PROGRAM button**  
This sets program playback. (☞ p. 28)



## ■ Contents





Speaker connection	18
Connecting an analog device	20
Connecting a digital device	20
Connecting an FM/AM antenna	21
Connecting the power cord	23

### NOTE

- Do not plug in the power cord until all connections have been completed.
- Do not bundle power cords with connection cables. Doing so can result in noise.

## ■ Cables used for connections

Provide necessary cables according to the devices you want to connect.

Speaker cable	
Subwoofer cable	
Optical cable	
Audio cable	

# Speaker connection

Here we connect the speakers in the room to this unit.

This section explains how to connect them using typical examples.

## NOTE

- Disconnect this unit's power plug from the power outlet before connecting the speakers. Also, turn off the subwoofer.
- Connect so that the speaker cable core wires do not protrude from the speaker terminal. The protection circuit may be activated if the core wires touch the rear panel or if the + and - sides touch each other. ("Protection circuit" (☞ p. 68))
- Never touch the speaker terminals while the power cord is connected. Doing so could result in electric shock.
- Use speakers with an impedance of 6 – 16  $\Omega$ /ohms.

## Connecting the speaker cables

Carefully check the left (L) and right (R) channels and + and – polarities on the speakers being connected to this unit, and be sure to connect the channels and polarities correctly.

- 1 Peel off about 3/8 inch (10 mm) of sheathing from the tip of the speaker cable, then twist the core wire tightly.**



- 2 Turn the speaker terminal counterclockwise to loosen it.**

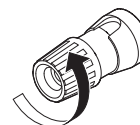

- 3 Insert the speaker cable's core wire to the hilt into the speaker terminal.**

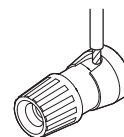

- 4 Turn the speaker terminal clockwise to tighten it.**

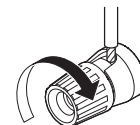

## Connecting the subwoofer

Use a subwoofer cable to connect the subwoofer.

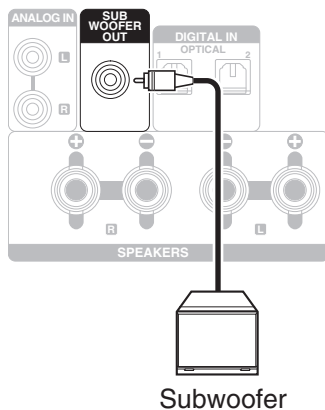

## Connecting speakers

Speaker  
(SC-M41,  
sold separately)

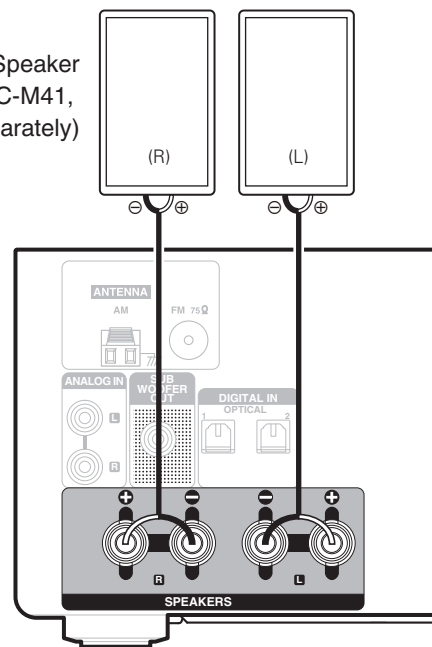

## Connecting an analog device

You can connect this unit to various devices with analog audio output.

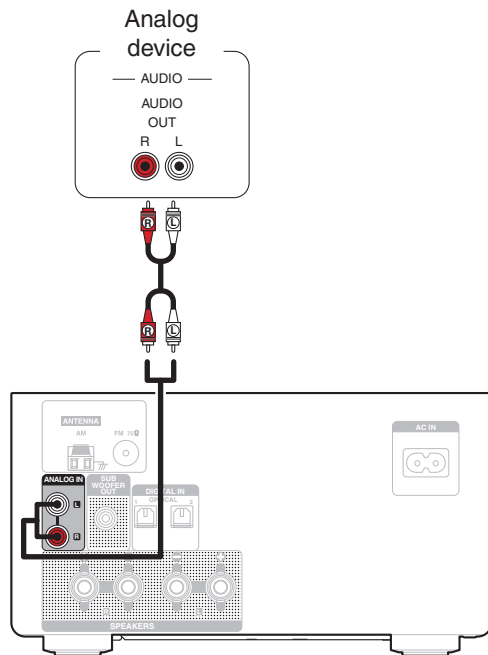

## Connecting a digital device

You can connect this unit to devices with digital audio output (TV, digital gear, etc.).

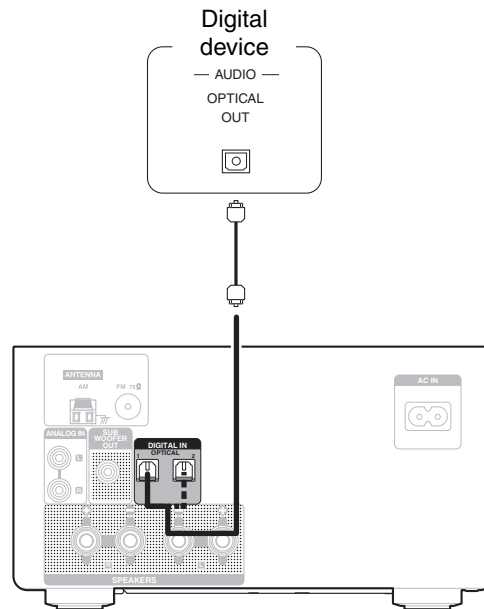

### ■ Specifications of supported audio formats

See "DIGITAL IN" (👉 p. 63).

## Connecting an FM/AM antenna

After connecting the antenna and receiving a broadcast signal, fix the antenna with tape in a position where the noise level becomes minimal. “Listening to FM/AM broadcasts” (👉 p. 31)

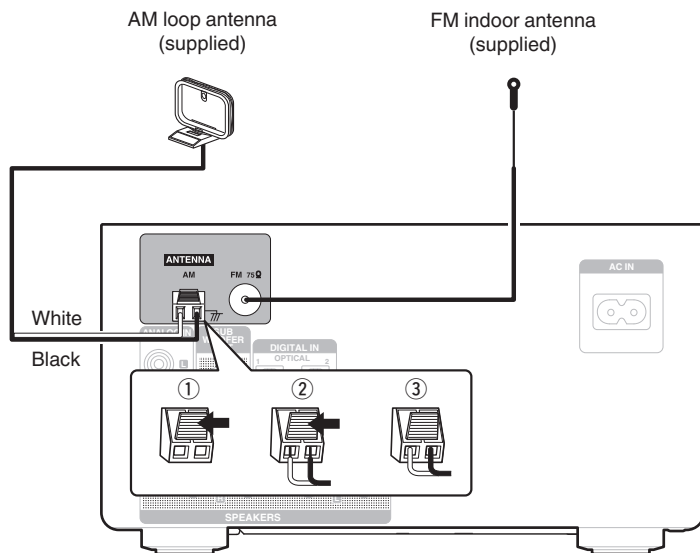

- If you are unable to receive a good broadcast signal, we recommend installing an outdoor antenna. For details, inquire at the retail store where you purchased the unit.

### NOTE

- Make sure the AM loop antenna lead terminals do not touch metal parts of the panel.



## ■ Using the AM loop antenna

### Suspending on a wall

Suspend directly on a wall without assembling.

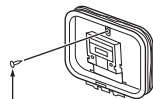

Nail, tack, etc.

### Standing alone

Use the procedure shown above to assemble.

When assembling, refer to “AM loop antenna assembly”.

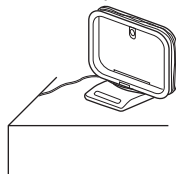

## ■ AM loop antenna assembly

- 1 Put the stand section through the bottom of the loop antenna from the rear and bend it forward.
- 2 Insert the projecting part into the square hole in the stand.

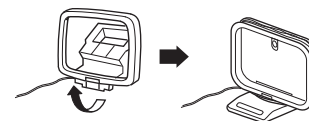
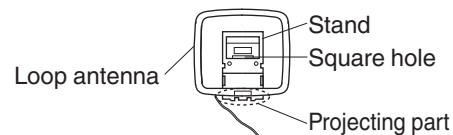

## Connecting the power cord

After completing all the connections, insert the power plug into the power outlet.

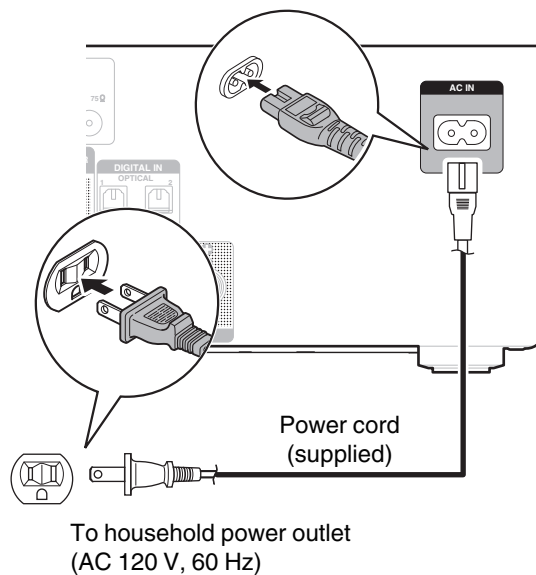

## ■ Contents

### Basic operation

---

Turning the power on	25
Switching the power to standby	25
Selecting the input source	26
Adjusting the volume	26
Turning off the sound temporarily (Muting)	26

### Playback a device

---

Playing CDs	27
Playing DATA CDs	29
Listening to FM/AM broadcasts	31
Listening to music on a Bluetooth device	35
Listening to DIGITAL IN	39
Listening to ANALOG IN	40

### Other functions

---

Convenience functions	41
-----------------------	----





## Basic operation

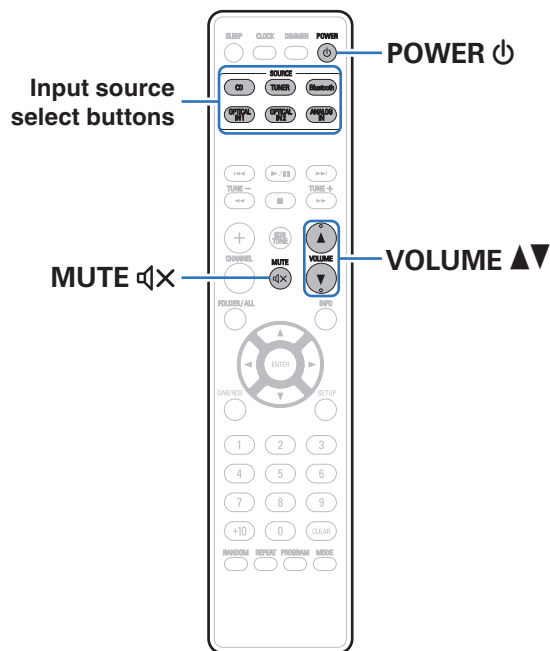

### Turning the power on

- 1 Press **POWER**  $\phi$  to turn on power to the unit.  
The power indicator lights green.



- You can also press  $\phi$  on the main unit to turn on power from standby mode.

### Switching the power to standby

- 1 Press **POWER**  $\phi$ .  
The unit switches to standby mode.



- You can also switch the power to standby by pressing  $\phi$  on the main unit.

#### NOTE

- Power continues to be supplied to some of the circuitry even when the power is in the standby mode. When leaving home for long periods of time or when going on vacation, unplug the power cord from the power outlet.



## Selecting the input source

### 1 Press the input source select button to be played back.

The desired input source can be selected directly.



- You can also select the input source by pressing  on the main unit.
- Press TUNER again while the source is set to "TUNER" to switch between FM/AM band.

## Adjusting the volume

### 1 Use VOLUME ▲▼ to adjust the volume.

The volume level is displayed.



- You can also adjust the volume by turning VOLUME on the main unit.

## Turning off the sound temporarily (Muting)

### 1 Press MUTE .

"MUTE ON" is displayed.



- To cancel mute, either adjust the sound volume or press MUTE  again.



# Playing CDs

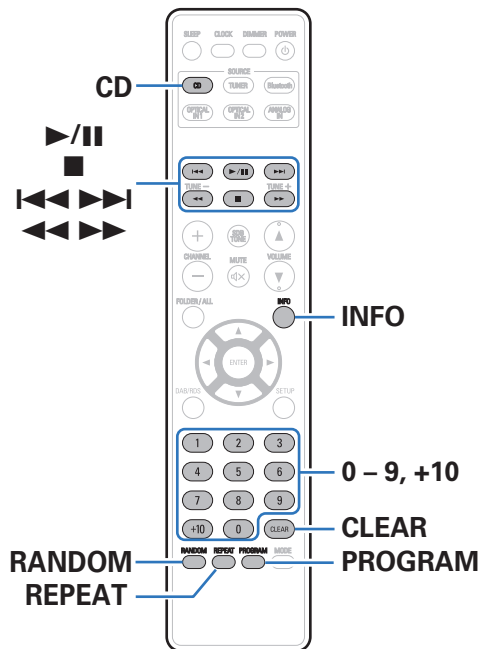

## Playing CDs

- 1 Press CD to switch the input source to “DISC”.
- 2 Insert a disc. (🔗 p. 64)  
Playback starts.
  - Press ▲ on the main unit to open/close the disc tray.







- You can set whether to automatically play CDs. (🔗 p. 50)

### NOTE

- Do not place any foreign objects in the disc tray. Doing so could result in damage.
- Do not push the disc tray in by hand when the power is turned off. Doing so could result in damage.



Operation buttons	Function
	Playback / Pause
	Stop
	Skip to previous track / Skip to next track
	(Press and hold) Fast-reverse / Fast-forward
0 - 9, +10	Select the track
RANDOM	Random playback
REPEAT	Repeat playback <ul style="list-style-type: none"> <li>Switching between Single-track repeat and All-track repeat.</li> </ul>
INFO	Switching the elapsed time display

## Playing tracks in a specific order (Program playback)

Up to 25 tracks can be programmed.

- 1 In the stop mode, press PROGRAM.**  
“PGM” is displayed.
- 2 Use 0 - 9 and +10 to select the tracks you want to program.**  
[Example]  
To program tracks 3, 12 to play in that order: Press 3, +10 and 2 one after the other.
- 3 Press .**  
Playback starts in the programmed order.



- The program is cleared when the disc tray is opened or the power is turned off.
- In the stop mode, press CLEAR, the last track programmed is cleared. Press  to select the track you want to delete.
- In the stop mode, press PROGRAM, clear the all programmed track.
- When RANDOM is pressed during program playback, the programmed tracks are played in random order.
- When REPEAT is pressed during program playback, the tracks are played repeatedly in the programmed order.



## Playing DATA CDs

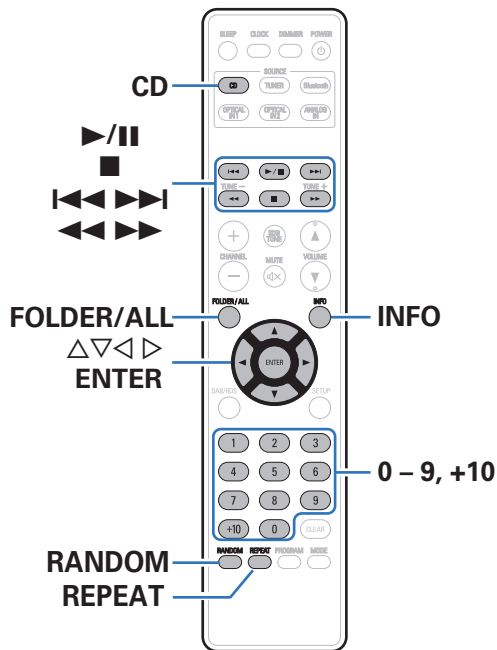

- This section explains how to playback music files that are recorded onto a CD-R or CD-RW.
- There are many music distribution sites on the Internet allowing you to download music files in MP3 or WMA (Windows Media® Audio) format. The music (files) downloaded from such sites can be stored on CD-R or CD-RW discs and played on this unit.

**“Windows Media” and “Windows” are the trademarks or registered trademarks of “Microsoft Corporation” in the United States and other countries.**

- The audio format types and specifications supported by this unit for playback are as follows.  
See “Playable files” for details. (📖 p. 62)
  - MP3
  - WMA



## Playing files

- 1 Press CD to switch the input source to “DISC”.
- 2 Load a CD-R or CD-RW containing music files into the disc tray. (🔧 p. 64)

Playback starts.

- Press ▲ on the main unit to open/close the disc tray.



- You can set whether to automatically play CDs. (🔧 p. 50)

Operation buttons	Function
▶/	Playback / Pause
■	Stop
◀◀▶▶	Skip to previous track / Skip to next track
◀◀▶▶	(Press and hold) Fast-reverse / Fast-forward
△▽	Folder select
◀▶	File select
0 - 9, +10	Select the track
<b>FOLDER/ALL</b>	Switch playback mode <ul style="list-style-type: none"> <li>• Switching between playing back all files within the selected folder or all tracks on the disc.</li> </ul>
<b>RANDOM</b>	Random playback
<b>REPEAT</b>	Repeat playback <ul style="list-style-type: none"> <li>• Switching between Single-track repeat and All-track repeat.</li> </ul>
<b>INFO</b>	Switching the File name, Title name/Artist name and Title name/Album name
<b>ENTER</b>	Enter the selected item



- English letters, numbers and certain symbols are displayed. Incompatible characters are displayed as “.” (period).

### ■ Files that can be played back

See “Playing back DATA CDs” (🔧 p. 62).



# Listening to FM/AM broadcasts

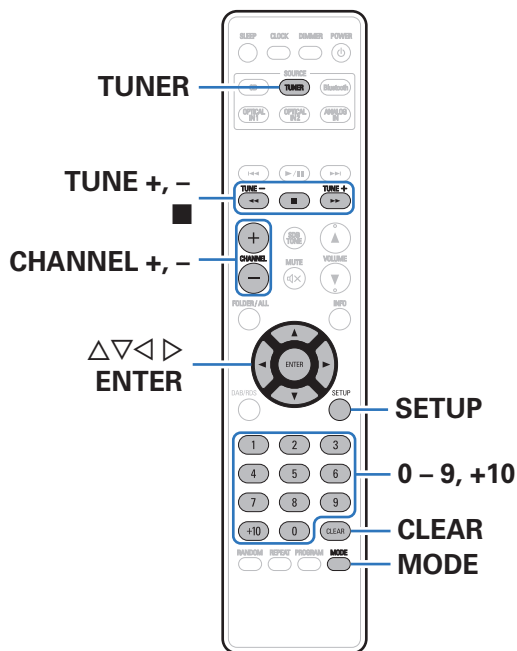

For details about how to connect the antenna, see “Connecting an FM/AM antenna” (🔗 p. 21).

## Listening to FM/AM broadcasts

### 1 Press TUNER to select the reception band.

<b>FM AUTO:</b>	When listening to an FM broadcast.
<b>FM MONO:</b>	If the signal is weak and stable stereo reception is not possible, select “FM MONO” to receive in monaural.
<b>AM:</b>	When listening to an AM broadcast.

- When “FM AUTO” is selected: “AUTO” is displayed.
- When the reception band is set to “FM AUTO”, the “ST” indicator lights when a stereo broadcast is tuned in.
- You can switch between “FM AUTO” and “FM MONO” while receiving an FM broadcast by pressing the MODE.

## 2 Use TUNE + or TUNE – to select the station you want listen to.

When a station is received, the “TUNED” indication will light.

- When “FM AUTO” is selected: Automatically search for and tune to a receivable radio station.
- When “FM MONO” is selected: Manually change the frequency one step at a time each time the button is pressed.

## Automatically presetting FM stations (Auto Preset)

This unit can be preset with a total of 40 FM broadcast stations.

- 1 Press **SETUP** during FM reception.
- 2 Use  $\Delta\nabla$  to select “**TUNER SETUP**”, then press **ENTER**.
- 3 Use  $\Delta\nabla$  to select “**FM AUTO PRESET**”, then press **ENTER**.
- 4 Press **ENTER** while “**PRESS ENTER**” is flashing.  
Broadcast stations are preset automatically.



- To stop auto tuning, press **■**.
- Broadcast stations whose antenna signals are weak cannot be preset automatically. If you wish to preset such stations, tune them in manually.
- AM stations cannot be automatically preset.

### NOTE

- When FM auto preset is performed, the channel currently registered as the FM preset is deleted, and the newly preset FM broadcast station is registered to the same number as the deleted channel.





## ■ Giving station names to preset channels

**1 Tune in the preset channel you want to name.**

**2 Press ENTER twice.**

The display switches to the station name input display.

**3 Input the station name.**

Names of up to 8 characters can be input.

$\Delta \nabla$ :	Selects the character.
$\triangleleft \triangleright$ :	Moves the cursor to the left or right.
<b>CLEAR</b> :	Deletes the currently selected character. (Press and hold) Press and hold for 3 seconds or more to clear all characters.

- Characters that can be input.  
[A – Z, 0 – 9, ^ ' ( ) \* + , - . / = (space)]

**4 Press ENTER.**

The characters you have input are entered.

- To give names to other stations, repeat steps 1 to 4.

## Presetting FM/AM stations manually

This unit can be preset with a total of 40 FM/AM broadcast stations.

**1 Tune in the station you want to preset.**

**2 Press ENTER.**

The minimum number display “P–” for the unregistered preset flashes.

**3 Use 0 – 9, +10 or CHANNEL +, – to select the number to be preset, then press ENTER.**

The reception frequency and reception mode are preset and the display switches to the station name input display.

### NOTE

- When the registered preset number is selected, “\*\*” is displayed. To overwrite this preset number, press ENTER.

**4 Input the station name.**

Names of up to 8 characters can be input.

$\Delta \nabla$ :	Selects the character.
$\triangleleft \triangleright$ :	Moves the cursor to the left or right.
<b>CLEAR</b> :	Deletes the currently selected character. (Press and hold) Press and hold for 3 seconds or more to clear all characters.

- Characters that can be input.  
[A – Z, 0 – 9, ^ ' ( ) \* + , - . / = (space)]



## Listening to preset stations

- 1 Use 0 – 9, +10 or CHANNEL –, + to select the preset number.

## Setting the preset channels and changing the received frequency on the main unit

Preset/Tuning buttons (–, +) on the main unit can be used both for switching the preset channel and for tuning.

Before operating them, switch the main unit to the “PRESET MODE” or “TUNING MODE” using the procedure below.

- 1 Press **SETUP**.
- 2 Use  $\Delta\nabla$  to select “**TUNER SETUP**”, then press **ENTER**.
- 3 Use  $\Delta\nabla$  to select “**MODE SELECT**”, then press **ENTER**.
- 4 Use  $\Delta\nabla$  to select “**PRESET MODE**” or “**TUNING MODE**”, then press **ENTER**.

---

### PRESET MODE:

Use Preset/Tuning buttons (–, +) on the main unit to switch preset channels.

- This is the same operation as CHANNEL – or CHANNEL + on the remote control unit.

---

### TUNING MODE:

Use Preset/Tuning buttons (–, +) on the main unit to change the received frequency.

- This is the same operation as TUNE – or TUNE + on the remote control unit.
- 



## Listening to music on a Bluetooth device

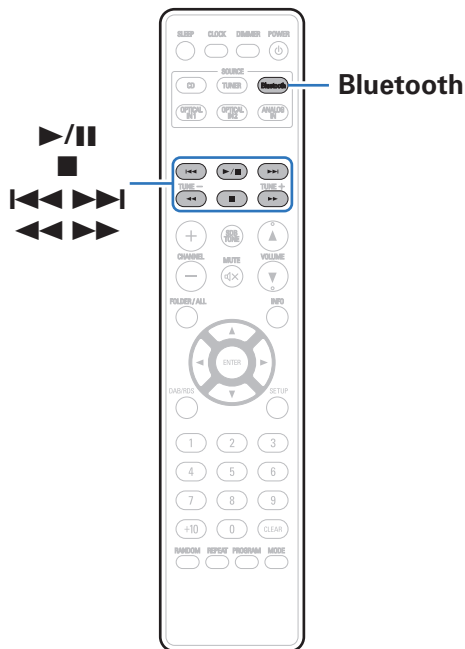

Music files stored on Bluetooth devices such as smartphones, digital music players, etc. can be enjoyed on this unit by pairing and connecting this unit with the Bluetooth device.

Communication is possible up to a range of about 32.8 ft/10 m.

### NOTE

- To play back music from a Bluetooth device, the Bluetooth device needs to support the A2DP profile.



## Playing music from Bluetooth device

In order to enjoy music from a Bluetooth device on this unit, the Bluetooth device must first be paired with this unit.

Once the Bluetooth device has been paired, it does not need to be paired again.

### 1 Press Bluetooth to switch the input source to “Bluetooth”.

When using for the first time, the unit will go into the pairing mode automatically and “Pairing” will appear on the display of the unit.

### 2 Activate the Bluetooth settings on your mobile device.

### 3 Select this unit when its name appears in the list of devices displayed on the screen of the Bluetooth device.

At the end of the pairing, the device name appears on the display of this unit.

- Connect to the Bluetooth device while “Pairing” is being displayed on the display of the unit.  
Perform the connection with the Bluetooth device close to the unit (about 1 m).

### 4 Play music using any app on your Bluetooth device.

- The Bluetooth device can also be operated with the remote control of this unit.
- The next time the input source is switched to Bluetooth, this unit automatically connects to the last Bluetooth device that was connected.







- When “Denon RCD-M41” is not displayed in the screen on the Bluetooth device, search for devices on the Bluetooth device.
- Enter “0000” when the password is requested on the screen of the Bluetooth device.
- English letters, numbers and certain symbols are displayed. Incompatible characters are displayed as “.” (period).

#### NOTE

- The pairing mode on this unit lasts for approx. 5 minutes. When the pairing mode on this unit is canceled before the pairing is completed, retry from step 1.
- This unit cannot perform pairing against a Bluetooth device with a pass key other than “0000”.



Operation buttons	Function
	Playback / Pause
	Stop
	Skip to previous track / Skip to next track
	(Press and hold) Fast-reverse / Fast-forward

**NOTE**

- To operate the Bluetooth device with the remote control of this unit, the Bluetooth device needs to support the AVRCP profile.
- The remote control of this unit is not guaranteed to work with all Bluetooth devices.
- Depending on the type of Bluetooth device, this unit outputs audio that is coupled to the volume setting on the Bluetooth device.

## Pairing with other Bluetooth devices

Pair a Bluetooth device with this unit.

- 1 Activate the Bluetooth settings on your mobile device.**
- 2 Press and hold Bluetooth for 3 seconds or longer.**  
The device will go into the pairing mode.
- 3 Select this unit when its name appears in the list of devices displayed on the screen of the Bluetooth device.**

At the end of the pairing, the device name appears on the display of this unit.



- This unit can be paired with a maximum of 8 Bluetooth devices. When a 9th Bluetooth device is paired, it will be registered in place of the oldest registered device.
- Enter "0000" when the password is requested on the screen of the Bluetooth device.



## Reconnecting to this unit from a Bluetooth device

After pairing is completed, the Bluetooth device can be connected without performing any operations on this unit.

This operation also needs to be performed when switching the Bluetooth device for playback.

- 1 If a Bluetooth device is currently connected, deactivate the Bluetooth setting of that device to disconnect it.**
- 2 Activate the Bluetooth setting of the Bluetooth device to be connected.**
- 3 Select this unit from the Bluetooth device list on your Bluetooth device.**
- 4 Play music using any app on your Bluetooth device.**



- When the power of this unit and the Bluetooth function of this unit are turned on, the input source will be automatically switched to “Bluetooth” if a Bluetooth device is connected.
- A Bluetooth device is connected with the unit in the Bluetooth standby state (Power indicator : Red), the power of the unit will be turned on automatically.

## Turning the Bluetooth function off for high sound performance playback

Stopping Bluetooth function reduces a source of noise that affects sound quality, enabling higher sound quality playback.

### 1 Press and hold Bluetooth for 8 seconds or longer.

“Bluetooth is OFF” is displayed on the display of this unit, the Bluetooth function of the unit is turned off.



- When the Bluetooth function of this unit is off and Bluetooth is pressed, the input source switches to Bluetooth and the Bluetooth function turns on.
- When the Bluetooth function of this unit is off, the input source of this unit will not switch to Bluetooth and the power will not switch on even if the connection operation of a Bluetooth device that is paired with this unit is performed.



OPTICAL IN1  
OPTICAL IN2



ANALOG IN

## Listening to DIGITAL IN

### 1 Prepare for playback.

Check the connection “Connecting a digital device” (👉 p. 20), then turn on this units.

### 2 Press OPTICAL IN1 or OPTICAL IN2 to switch the input source to “OPTICAL IN 1” or “OPTICAL IN 2”.

### 3 Play the component connected to this unit.

#### NOTE

- Do not input non-PCM signals, such as Dolby Digital, and DTS. This causes noise and could damage the speakers.
- “SIGNAL UNLOCK” is displayed when audio signals that are not supported by this unit are input, or the sampling frequency cannot be detected.

### ■ Specifications of supported audio formats

See “DIGITAL IN” (👉 p. 63).



## Listening to ANALOG IN

---

- 1 Prepare for playback.**  
Check the connection, then turn on this units.
- 2 Press ANALOG IN to switch the input source to “ANALOG IN”.**
- 3 Play the component connected to this unit.**





# Convenience functions

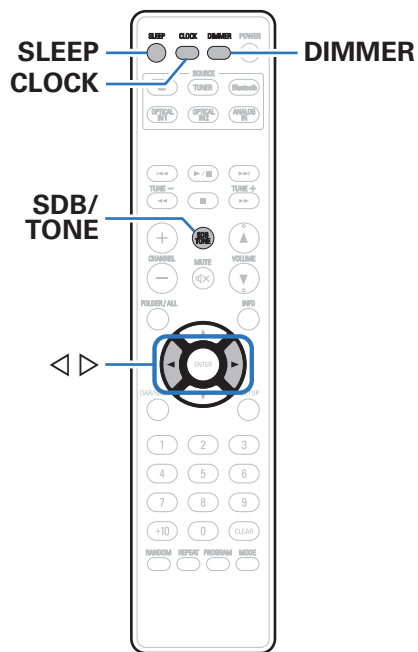

Adjusting the tone	42
Sleep timer function	43
Checking the current time	43
Switching the display's brightness	44

## Adjusting the tone

- 1 Press **SDB/TONE** to select the tone parameter to be adjusted.
- 2 Use **<|>** to adjust the “**SDB**”, “**BASS**”, “**TREBLE**”, “**BALANCE**” or “**S.DIRECT**”.

### ❑ SDB (Super Dynamic Bass)

<b>ON:</b>	Emphasizes the bass sound (maximum +8 dB).
<b>OFF</b> (Default):	Disable SDB (Super Dynamic Bass) function.

### ❑ BASS

Adjusts the bass sound.

**-10 dB – +10 dB** (Default : 0 dB)

### ❑ TREBLE

Adjusts the treble sound.

**-10 dB – +10 dB** (Default : 0 dB)

### ❑ BALANCE

Use **<|>** to adjust the left/right volume balance.

### ❑ S.DIRECT (Source Direct)

<b>ON:</b>	Playback sound is closer to the source sound.
<b>OFF</b> (Default):	Disable S.DIRECT (Source Direct) function.



## Sleep timer function

You can have the power automatically switched to standby once a set time has elapsed. This is convenient for listening while going to sleep.

### 1 Press SLEEP during playback and select the setting time.

- The “SLEEP” indicator on the display lights.
- You can set the sleep timer in the range from 10 to 90 minutes in steps of 10 minutes.

### ■ To cancel the sleep timer

Press SLEEP to set “SLEEP OFF”.

The “SLEEP” indicator on the display turns off.



- The sleep timer setting is canceled when the unit switches to standby mode.
- To check the time remaining until the sleep timer is activated, press SLEEP.

## Checking the current time

Be sure to set the current time using “CLOCK SETUP” in the setup menu in advance. (✎ p. 47)

### ■ Checking the current time when the power is on

Press CLOCK.

- Press once more and the display returns to its original condition.

### ■ Checking the current time when the power is set to standby

Press CLOCK.

- The current time is displayed for 10 seconds.



- When the “CLOCK MODE” of the setup menu is “ON”, the current time is continually displayed even when the power is set to standby. (✎ p. 50)
- This unit displays the time in 12-hour format.



## Switching the display's brightness

The brightness of the display can be adjusted to one of four levels.

### 1 Press DIMMER.

- The brightness of the display switches each time the button is pressed.



- If the buttons are operated when the display is turned off, information is displayed temporarily at a low brightness level.
- The display brightness is set to most brightly by default.



## Menu map

For menu operations, see the following page.

By default, this unit has recommended settings defined. You can customize this unit based on your existing system and your preferences.

Setting items	Description	Page
<b>CLOCK SETUP</b>	Sets the current time.	<a href="#">47</a>
<b>ALARM SETUP</b>	Sets the timer playback.	<a href="#">47</a>
<b>ALARM ON/OFF</b>	Set the timer playback to on or off.	<a href="#">48</a>
<b>H/P AMP GAIN</b>	Set the gain of the headphone amplifier. Set this according to the impedance of the connected headphones.	<a href="#">49</a>
<b>SPK OPTIMISE</b>	Sets the optimum playback properties of the speakers (SC-M41, sold separately).	<a href="#">49</a>
<b>AUTO STANDBY</b>	Sets whether to automatically switch the unit to the standby mode when there is no input signal and operation for 15 minutes.	<a href="#">49</a>
<b>CD AUTO PLAY</b>	Set whether or not to automatically play a disc when the disc is inserted.	<a href="#">50</a>
<b>TUNER SETUP</b>	The following 2 items are displayed when "TUNER SETUP" is selected.	–
<b>FM AUTO PRESET</b>	Automatically presets FM channels.	<a href="#">32</a>
<b>MODE SELECT</b>	Uses the Preset/Tuning buttons (–, +) on the unit to set whether to switch between channels registered as presets, or whether to switch the reception frequency one step at a time.	<a href="#">34</a>
<b>CLOCK MODE</b>	The clock is constantly displayed.	<a href="#">50</a>



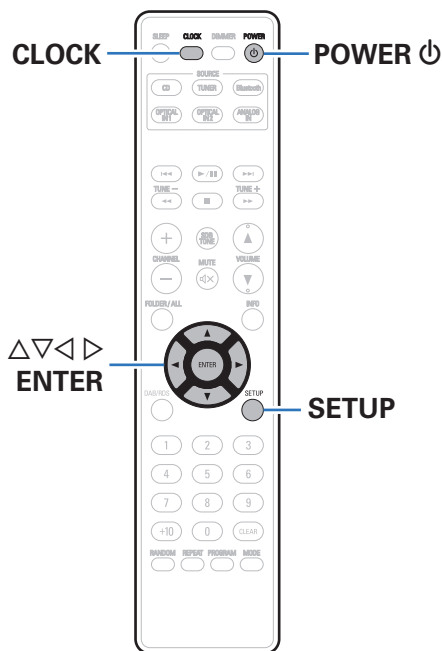

## Menu operation

- 1 Press SETUP.**  
The menu is displayed on the display.
- 2 Use  $\Delta$ / $\nabla$  to select the menu to be set or operated, then press ENTER.**
- 3 Use  $\Delta$ / $\nabla$ / $\triangleleft$ / $\triangleright$  to change to desired setting.**
- 4 Press ENTER to enter the setting.**
  - To return to the previous item, press  $\triangleleft$ .
  - Exiting the Menu, press SETUP while the menu is displayed. The menu display disappears.

## CLOCK SETUP

Sets the current time.

**1 Use  $\Delta\nabla$  to set the “hours”.**

**2 Press ENTER.**

The “minutes” display flashes.

**3 Use  $\Delta\nabla$  to set the “minutes”.**

**4 Press ENTER.**

The current time is set, and the menu display disappears.

**Checking the current time when the power is on**

Press CLOCK.

Press once more and the display returns to its original condition.

**Checking the current time when the power is set to standby**

Press CLOCK.

The current time is displayed for 10 seconds.



- The time cannot be set when in the standby mode. Turn on the power first.

## ALARM SETUP

Audio from the set input source can be played back at a specified time.

Audio can also be played at the same time every day.

**1 Use  $\Delta\nabla\triangleleft\rangle$  to change to desired setting, then press ENTER to enter the setting.**

① **MODE SELECT**

Use  $\Delta\nabla$  to select the alarm mode, then press ENTER.

**ONCE ALARM:**

Playback starts and stops (the power turns off) once only at the set times.

**EVERYDAY ALARM:**

Playback starts and stops (the power turns off) at the set times each day.

② **SOURCE SELECT**

Use  $\Delta\nabla$  to select the source, then press ENTER.

**DISC / TUNER / ANALOG IN / OPTICAL IN 1 / OPTICAL IN 2 / Bluetooth**



- If you have selected “TUNER” in “SOURCE SELECT”, select the Preset Number.
- When no name has been registered for the selected preset number, the frequency appears after the preset number is displayed.
- When “Bluetooth” is selected, this unit attempts to connect to the previously connected device.
- The alarm may not work on some Bluetooth devices.



## ③ VOLUME SELECT

Use  $\Delta \nabla$  to adjust the volume, then press ENTER.

## ④ ON TIME

Use  $\Delta \nabla$  to select “hours” for the alarm start time, then press ENTER.

Use  $\Delta \nabla$  to select “minutes” for the alarm start time, then press ENTER.

## ⑤ OFF TIME

Use  $\Delta \nabla$  to select “hours” for the alarm stop time, then press ENTER.

Use  $\Delta \nabla$  to select “minutes” for the alarm stop time, then press ENTER.

## ⑥ ALARM ON/OFF

Use  $\triangleleft \triangleright$  to select “ON” or “OFF” for the alarm, then press ENTER.



- The  $\odot$  indicator lights and the alarm setting is entered.
- The alarm settings are displayed for 3 seconds.

## 2 Press POWER $\odot$ to set the power to standby.

Alarm standby mode is set, and the power indicator lights orange.

## ALARM ON/OFF

Set the timer playback to on or off.

**1 Use  $\Delta \nabla$  to select “ONCE” or “EVERYDAY”.**

**2 Use  $\triangleleft \triangleright$  to select “ON” or “OFF” for the alarm, then press ENTER.**

The alarm settings are displayed.

- When set to “OFF”, time operation is disabled, but the alarm settings remain unchanged.





## H/P AMP GAIN

Set the gain of the headphone amplifier. Set this according to the impedance of the connected headphones. It is recommended that this is set on the "LOW" side if the headphones have low impedance and on the "HIGH" side if they have high impedance.

**HIGH:** Set the gain of the headphone amplifier to "HIGH". Set when there is insufficient volume, even when the gain setting is "MIDDLE".

**MIDDLE (Default):** Set the gain of the headphone amplifier to "MIDDLE".

**LOW:** Set the gain of the headphone amplifier to "LOW". Set if the volume is too high when the gain setting is "MIDDLE".



- The headphone volume varies depending on the "H/P AMP GAIN" setting. Decrease the volume or mute the audio first if changing this setting while listening to audio.

## SPK OPTIMISE

An optimizing filter suited for the properties of the speakers (SC-M41) can be used.

**ON (Default):** The response is optimized for the speakers (SC-M41, sold separately).

**OFF:** The response is flat.

## AUTO STANDBY

When there is no input signal and operation for 15 minutes, this unit automatically enters the standby mode.

**ON:** The unit goes into standby after 15 minutes.

**OFF (Default):** The unit does not go into standby automatically.



- For the input source "ANALOG IN" only, when no operation is performed for eight hours, this unit automatically enters the standby mode.
- When you use the tuner, the Auto standby function does not operate.



## CD AUTO PLAY

When the CD tray is closed, the unit can detect the DISC, automatically switch the input source to DISC and start playback of the disc.

<b>ON</b> (Default):	Performs automatic playback.
<b>OFF:</b>	Does not perform automatic playback.

## CLOCK MODE

The clock is constantly displayed.

<b>ON:</b>	Display the clock. Press the POWER $\odot$ button to switch between the clock display and the normal display.
<b>OFF</b> (Default):	Does not display the clock.

### NOTE

- When "CLOCK MODE" is set to "ON", this unit consumes the same amount of power as when it is turned on.



## ■ Contents

### Tips

I want to play back music with a single operation from the standby state	52
I want to turn on power to this unit from a Bluetooth device	52
I want to listen to high sound performance playback	52
I want to adjust the tone myself	52
I want sound playback that is faithful to the original sound	52
I want to display the clock constantly	52
I want to make the volume of the headphones the same as that of the speakers	52

### Troubleshooting

Power does not turn on / Power is turned off	53
LED is flashing	54
Operations cannot be performed through the remote control unit	55
Display on this unit shows nothing	55
No sound comes out	56
Desired sound does not come out	57
Audio from digital devices cannot be played back (Optical)	57
Sound is interrupted or noise occurs	58
Cannot playback Discs	59
Bluetooth cannot be played back	60



## Tips

### I want to play back music with a single operation from the standby state

- When a input source select buttons, ►/|| button or ▲ button is pressed, the operation is performed at the same time as the unit switches on.

### I want to turn on power to this unit from a Bluetooth device

- Once you perform pairing between this unit and a Bluetooth device, you can turn on power to this unit by operating the Bluetooth device. Select “Denon RCD-M41” from the list of Bluetooth devices to turn on power to this unit.

### I want to listen to high sound performance playback

- Turning off the Bluetooth function suppresses a source of noise that affects sound quality, enabling high sound performance playback. Press and hold the Bluetooth button for approximately 8 seconds. (🔧 p. 38)

### I want to adjust the tone myself

- Press the SDB/TONE button to set “SDB”, “BASS”, “TREBLE” and “BALANCE”. (🔧 p. 42)

### I want sound playback that is faithful to the original sound

- Press the SDB/TONE button to set “S.DIRECT” to “ON”. (🔧 p. 42)

### I want to display the clock constantly

- The clock can be constantly displayed by turning the “CLOCK MODE” on. (🔧 p. 50)

### I want to make the volume of the headphones the same as that of the speakers

- You can increase the sound from the headphones at the same volume setting by changing the “H/P AMP GAIN” settings. (🔧 p. 49)



## Troubleshooting



If a problem should arise, first check the following.

1. **Are the connections correct?**
2. **Is the set being operated as described in the owner's manual?**
3. **Are the other devices operating properly?**

If this unit does not operate properly, check the items listed in the table below.

Should the problem persist, there may be a malfunction. In this case, disconnect the power immediately and contact your store of purchase.

### ■ Power does not turn on / Power is turned off

Symptom	Cause / Solution	Page
Power does not turn on.	• Check whether the power plug is correctly inserted into the power outlet.	<u>23</u>
	• This unit is in standby mode. Press the  button on the unit or the POWER  button on the remote control.	<u>25</u>
Power automatically turns off.	• The sleep timer is set. Turn on the power again.	<u>43</u>
	• "AUTO STANDBY" is set. "AUTO STANDBY" is triggered when there is no operation for a set amount of time. To disable "AUTO STANDBY", set "AUTO STANDBY" on the menu to "OFF".	<u>49</u>



## ■ LED is flashing

Symptom	Cause / Solution	Page
Flashing red. (Flashes at 0.25 second intervals)	<ul style="list-style-type: none"> <li>The amplifier circuit in the unit has malfunctioned. Disconnect the power and contact the repair center.</li> </ul>	—
Flashing red. (Flashes at 0.5 second intervals)	<ul style="list-style-type: none"> <li>Protection circuit activated due to a rise in internal temperature. Turn off the power, wait for the set to fully cool down, then turn the power back on.</li> </ul>	<a href="#">68</a>
	<ul style="list-style-type: none"> <li>Core wires of two speakers are touching each other or a core wire is sticking out of the terminal and touching the set's rear panel, activating the protection circuit. First unplug the power cord, then twist the core wires tightly or terminate the speaker cables, then reconnect.</li> </ul>	<a href="#">68</a>



## ■ Operations cannot be performed through the remote control unit

Symptom	Cause / Solution	Page
Operations cannot be performed through the remote control unit.	• Batteries are worn out. Replace with new batteries.	<a href="#">6</a>
	• Operate the remote control unit within a distance of about 23 ft/7 m from this unit and at an angle of within 30°.	<a href="#">6</a>
	• Remove any obstacle between this unit and the remote control unit.	—
	• Insert the batteries in the proper direction, checking the ⊕ and ⊖ marks.	<a href="#">6</a>
	• The set's remote control sensor is exposed to strong light (direct sunlight, inverter type fluorescent bulb light, etc.). Move the set to a place in which the remote control sensor will not be exposed to strong light.	—
	• When using a 3D video device, the remote control unit of this unit may not function due to effects of infrared communications between units (such as TV and glasses for 3D viewing). In this case, adjust the direction of units with the 3D communications function and their distance to ensure they do not affect operations from the remote control unit of this unit.	—

## ■ Display on this unit shows nothing

Symptom	Cause / Solution	Page
Display is off.	• Press the DIMMER button on the remote control to set any setting other than off.	<a href="#">44</a>



## ■ No sound comes out

Symptom	Cause / Solution	Page
No sound comes out of speakers.	• Check the connections for all devices.	<a href="#">17</a>
	• Insert connection cables all the way in.	—
	• Check that input connectors and output connectors are not reversely connected.	—
	• Check cables for damage.	—
	• Check that speaker cables are properly connected. Check that cable core wires come in contact with the metal part on speaker terminals.	<a href="#">18</a>
	• Securely tighten the speaker terminals. Check speaker terminals for looseness.	<a href="#">18</a>
	• Check that a proper input source is selected.	<a href="#">26</a>
	• Adjust the volume.	<a href="#">26</a>
	• Cancel the mute mode.	<a href="#">26</a>
	• Check that the correct input source is selected when audio is being input to this unit from an external device.	<a href="#">39</a>
	• Check the digital audio output setting on the connected device. The initial settings may be off depending on the device.	—
	• Do not input non-PCM signals, such as Dolby Digital, and DTS. This causes noise and could damage the speakers.	<a href="#">39</a>
	• No sound is output from the speakers when headphones are connected.	<a href="#">10</a>
• To playback via a Bluetooth connection, perform pairing between this unit and the Bluetooth device.	<a href="#">36</a>	





## ■ Desired sound does not come out

Symptom	Cause / Solution	Page
Left/right volume balance is unbalanced.	<ul style="list-style-type: none"> <li>Press the SDB/TONE button on the remote control to adjust the balance.</li> </ul>	<a href="#">42</a>
No sound from the sub woofer.	<ul style="list-style-type: none"> <li>Check the subwoofer connections.</li> </ul>	<a href="#">19</a>
	<ul style="list-style-type: none"> <li>Switch the subwoofer power on.</li> </ul>	—
Set values are not reflected in “SDB (Super Dynamic Bass)”, “BASS” and “TREBLE”.	<ul style="list-style-type: none"> <li>“SDB (Super Dynamic Bass)”, “BASS” and “TREBLE” setting values are not reflected in subwoofer out.</li> </ul>	<a href="#">42</a>
	<ul style="list-style-type: none"> <li>Set “OFF” to the “S.DIRECT”.</li> </ul>	<a href="#">42</a>
Headphone volume is low.	<ul style="list-style-type: none"> <li>Switch “H/P AMP GAIN” to “MIDDLE” or “HIGH” if using headphones with high impedance or low sensitivity.</li> </ul>	<a href="#">49</a>

## ■ Audio from digital devices cannot be played back (Optical)

Symptom	Cause / Solution	Page
“SIGNAL UNLOCK” is displayed.	<ul style="list-style-type: none"> <li>When digital audio signals cannot be detected properly, “SIGNAL UNLOCK” is displayed.</li> </ul>	<a href="#">39</a>
	<ul style="list-style-type: none"> <li>“SIGNAL UNLOCK” is displayed when audio signals that are not supported by this unit are input. Check the audio output signal format from your digital device.</li> </ul>	<a href="#">39</a>



## ■ Sound is interrupted or noise occurs

Symptom	Cause / Solution	Page
When making a call on iPhone, noise occurs in audio output on this unit.	<ul style="list-style-type: none"> <li>When making a call, keep a distance of 0.7 ft/20 cm or longer between iPhone and this unit.</li> </ul>	—
Noise often occurs in FM/AM broadcasting.	<ul style="list-style-type: none"> <li>Change the antenna orientation or position.</li> </ul>	<u>21</u>
	<ul style="list-style-type: none"> <li>Use an outdoor antenna.</li> </ul>	<u>21</u>
	<ul style="list-style-type: none"> <li>Separate the antenna from other connection cables.</li> </ul>	<u>21</u>
During playback from the CD-R/CD-RW, sound is occasionally interrupted.	<ul style="list-style-type: none"> <li>This may be caused by poor recording conditions, or the disc itself may be of poor quality. Use a correctly recorded disc.</li> </ul>	—



## ■ Cannot playback Discs

Symptom	Cause / Solution	Page
Cannot playback when the ►/   button is pressed, or cannot correctly play back a specific part of the disc.	<ul style="list-style-type: none"> <li>The disc is dirty or scratched. Either clean the disc, or insert a different disc.</li> </ul>	<a href="#">64</a>
Cannot playback CD-R/CD-RW.	<ul style="list-style-type: none"> <li>CDs cannot be played back unless they have been finalized. Use a finalized disc.</li> </ul>	<a href="#">64</a>
	<ul style="list-style-type: none"> <li>This may be caused by poor recording conditions, or the disc itself may be of poor quality. Use a correctly recorded disc.</li> </ul>	—
	<ul style="list-style-type: none"> <li>The DATA CD playback function of this unit only supports playback of MP3 and WMA files.</li> </ul>	<a href="#">62</a>
“Unsupported” is displayed.	<ul style="list-style-type: none"> <li>“Unsupported” is displayed if a disc that cannot be played is loaded.</li> </ul>	<a href="#">64</a>
“NO DISC” is displayed.	<ul style="list-style-type: none"> <li>“NO DISC” is displayed if the disc is loaded upside-down or if no disc is loaded.</li> </ul>	<a href="#">64</a>



## ■ Bluetooth cannot be played back

Symptom	Cause / Solution	Page
Bluetooth devices cannot be connected to this unit.	• The Bluetooth function in the Bluetooth device has not been enabled. See the Owner's Manual of the Bluetooth device to enable the Bluetooth function.	—
	• Bring the Bluetooth device near to this unit.	—
	• The Bluetooth device cannot connect with this unit if it is not compatible with the A2DP profile.	—
	• Turn the power of the Bluetooth device off and on again, and then try again.	—
	• The Bluetooth function is off. Press Bluetooth button, activate the Bluetooth function and connect again.	<a href="#">38</a>
The sound is cut off.	• Bring the Bluetooth device near to this unit.	—
	• Remove obstructions between the Bluetooth device and this unit.	—
	• To prevent electromagnetic interference, locate this unit away from microwave ovens, wireless LAN devices and other Bluetooth devices.	—
	• Reconnect the Bluetooth device.	—





## Resetting factory settings

Perform this procedure if the display is abnormal or if operations cannot be performed.

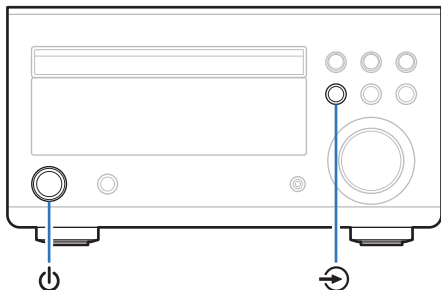
Various settings are reset to the factory default values. Make settings again.



- 1 Place this unit in Standby mode using .**
- 2 While pressing and holding , press and hold  for 3 seconds.**

"INITIALIZE" is displayed.



- Repeat this process if "INITIALIZE" is not displayed.

## Playing back DATA CDs

### ■ DATA CDs formats

CD-R and CD-RW discs created in the format described below can be played.

#### Writing software format

ISO9660 level 1

When written in other formats, it may not be possible to play the disc properly.

#### Maximum number of playable files and folders

Total number of folders and files : 512

Maximum number of folders : 256

#### File format

MPEG-1 Audio Layer-3

WMA (Windows Media Audio)

#### Tag data

ID3-Tag (Ver. 1.x and 2.x)

META-Tag (Compatible with title, artist and album names)

### ■ Playable files

	Sampling frequency	Bit rate	Extension
MP3	32/44.1/48 kHz	32 – 320 kbps	.mp3
WMA	32/44.1/48 kHz	64 – 192 kbps	.wma



- Be sure to give files the extension “.MP3” or “.WMA”. Files with any other extensions or files with no extensions cannot be played.
- Mac OS X files assigned with filenames that begin with “\_” are not music data and cannot be played back.
- In accordance with copyright laws, recordings you have made should only be used for your personal enjoyment and may not be used in other ways without permission of the copyright holder.



## DIGITAL IN

### ■ Specifications of supported audio formats

#### □ Optical

	Sampling frequency	Bit length
Linear PCM (2-channel)	32/44.1/48/88.2/96/ 176.4/192 kHz	16/24 bits

## Playing back Bluetooth devices

This unit supports the following Bluetooth profiles.

- A2DP (Advanced Audio Distribution Profile) :  
When a Bluetooth device that supports this standard is connected, monaural and stereo sound data can be streamed at a high quality.
- AVRCP (Audio/Video Remote Control Profile) :  
When a Bluetooth device that supports this standard is connected, the Bluetooth device can be operated from this unit.

### ■ About Bluetooth communications

Radio waves broadcast from this unit may interfere with the operation of medical devices. Make sure you turn off the power of this unit and Bluetooth device in the following locations as radio wave interference may cause malfunctions.

- Hospitals, trains, aircraft, petrol kiosks and places where flammable gases are generated
- Near automatic doors and fire alarms



## About Discs

### ■ Discs playable on this unit

#### ① Music CDs

Discs marked with the logo below can be played in this unit.



#### ② CD-R/CD-RW

##### NOTE

- Discs in special shapes (heart-shaped discs, octagonal discs, etc.) cannot be played. Do not attempt to play them, as doing so can damage the unit.
- Some discs and some recording formats cannot be played.
- Non-finalized discs cannot be played.
- If the unit is left in a room full of smoke from cigarettes, etc., for long periods of time, the surface of the optical pickup may get dirty, preventing it from receiving signals properly.



### ■ Loading discs

- Place the disc in the tray, label side up.
- Make sure the disc tray is fully open when inserting the disc.
- Place the discs flat, 5 inch/12 cm discs in the outer tray guide, 3 inch/8 cm discs in the inner tray guide.
- Place 3 inch/8 cm discs in the inner tray guide without using an adapter.



- "Unsupported" is displayed if a disc that cannot be played is loaded.
- "NO DISC" is displayed if the disc is loaded upside-down or if no disc is loaded.

##### NOTE

- Do not push the disc tray in by hand when the power is turned off. Doing so could damage the set.
- Do not place any foreign objects in the disc tray. Doing so could damage the set.
- If the unit is left in a room full of smoke from cigarettes, etc., for long periods of time, the surface of the optical pickup may get dirty, preventing it from receiving signals properly.





## ■ Cautions on loading discs

- Only load one disc at a time. Loading two or more discs can damage the unit or scratch the discs.
- Do not use cracked or warped discs or discs that have been repaired with adhesive, etc.
- Do not use discs on which the sticky part of cellophane tape or labels is exposed or on which there are traces of where labels have been removed. Such discs can get caught inside the player and damage it.

## ■ Cautions on handling

- Do not get fingerprints, oil or dirt on discs.
- Take special care not to scratch discs when removing them from their cases.
- Do not bend or heat discs.
- Do not enlarge the hole in the center.
- Do not write on the labeled (printed) surface with ball-point pens, pencils, etc., or stick new labels on discs.
- Water droplets may form on discs if they are moved suddenly from a cold place (outdoors for example) to a warm place, but do not try to dry them off using a hairdryer, etc.

## ■ Cautions on storing discs

- Be sure to remove discs after using them.
- Be sure to store discs in their cases to protect them from dust, scratches, warping, etc.
- Do not store discs in the following places:
  1. Places exposed to direct sunlight for long periods of time
  2. Dusty or humid places
  3. Places exposed to heat from heaters, etc.

## ■ Cleaning discs

- If there are fingerprints or dirt on a disc, wipe them off before using the disc. Fingerprints and dirt can impair sound quality and cause interruptions in playback.
- Use a commercially available disc cleaning set or a soft cloth to clean discs.



Gently wipe the disc from the inside towards the outside.

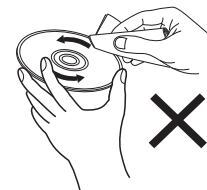

Do not wipe with a circular motion.

### NOTE

- Do not use record spray, antistatic agents, benzene, thinner or other solvents.

## Last function memory

---

This stores the settings as they were immediately before going into the standby mode.

When the power is turned back on, the settings are restored to as they were immediately before going into the standby mode.



## Explanation of terms

---

### ■ Audio

#### MP3 (MPEG Audio Layer-3)

This is an internationally standardized audio data compression scheme, using the “MPEG-1” video compression standard. It compresses the data volume to about one eleventh its original size while maintaining sound quality equivalent to a music CD.

#### WMA (Windows Media Audio)

This is audio compression technology developed by Microsoft Corporation.

WMA data can be encoded using Windows Media<sup>®</sup> Player. To encode WMA files, only use applications authorized by Microsoft Corporation. If you use an unauthorized application, the file may not work properly.

#### Sampling frequency

Sampling involves taking a reading of a sound wave (analog signal) at regular intervals and expressing the height of the wave at each reading in digitized format (producing a digital signal).

The number of readings taken in one second is called the “sampling frequency”. The larger the value, the closer the reproduced sound is to the original.

#### Speaker impedance

This is an AC resistance value, indicated in  $\Omega$  (ohms). Greater power can be obtained when this value is smaller.

#### Bit rate

This expresses the read amount per 1 second of video/audio data recorded. A larger number means higher sound quality, but also means a larger file size.



## ■ Others

### Finalizing

Finalization is the process that makes recorded CD-R/CD-RW discs playable on compatible players.

### Pairing

Pairing (registration) is an operation that is required in order to connect a Bluetooth device to this unit using Bluetooth. When paired, the devices authenticate each other and can connect without mistaken connections occurring.

When using Bluetooth connection for the first time, you need to pair this unit and the Bluetooth device to be connected.

### Protection circuit

This is a function to prevent damage to devices within the power supply when an abnormality such as an overload, excess voltage occurs or over temperature for any reason.



## Trademark information



The Bluetooth® word mark and logos are registered trademarks owned by Bluetooth SIG, Inc. and any use of such marks by D&M Holdings Inc. is under license. Other trademarks and trade names are those of their respective owners.



Adobe, the Adobe logo and Reader are either registered trademarks or trademarks of Adobe Systems Incorporated in the United States and/or other countries.



# Specifications

## ■ Audio section

- CD player

**Playable frequency response:**

2 Hz - 20 kHz

**Wow & flutter:**

Below measurable limits ( $\pm 0.001\%$ )

**Sampling frequency:**

44.1 kHz

- Audio amplifier

**Rated output:**

2-channel

30 W + 30 W (6  $\Omega$ /ohms, 1 kHz, T.H.D. 10 %)

## ■ Tuner section

**Receiving Range:**

**[FM]**

87.5 MHz – 107.9 MHz

**[AM]**

520 kHz – 1710 kHz

**Effective sensitivity:**

1.2  $\mu$ V / 75  $\Omega$ /ohms

20  $\mu$ V

**FM STEREO separation:**

35 dB (1 kHz)

**FM S/N ratio:**

Monaural : 65 dB

Stereo : 60 dB

**FM THD+N (1 kHz):**

Monaural : 0.2 %

Stereo : 0.5 %



## ■ Bluetooth section

<b>Communications system:</b>	Bluetooth Version 4.0
<b>Transmission power:</b>	Power Class 1
<b>Maximum communication range:</b>	Approx. 10 m in line of sight*
<b>Frequency band:</b>	2.4 GHz band
<b>Modulation scheme:</b>	FHSS (Frequency-Hopping Spread Spectrum)
<b>Supported profiles:</b>	A2DP (Advanced Audio Distribution Profile) 1.3 AVRCP (Audio Video Remote Control Profile) 1.5
<b>Corresponding codec:</b>	SBC, AAC
<b>Transmission range (A2DP):</b>	20 Hz - 20,000 Hz

\*The actual communication range varies depending on the influence of such factors as obstructions between devices, electromagnetic waves from microwave ovens, static electricity, cordless phones, reception sensitivity, antenna performance, operating system, application software etc.



## ■ Clock/Alarm/Sleep

<b>Clock type:</b>	Crystal oscillator (Within 1 – 2 minutes per month)
<b>Alarm:</b>	Once alarm/Everyday alarm: One system each
<b>Sleep:</b>	Sleep timer: Max. 90 minutes

## ■ General

<b>Power supply:</b>	AC 120 V, 60 Hz
<b>Power consumption:</b>	70 W
<b>Power consumption in clock mode :</b>	14 W
<b>Power consumption in standby mode :</b>	0.3 W

- For purposes of improvement, specifications and design are subject to change without notice.





## ■ Dimensions

Unit : mm

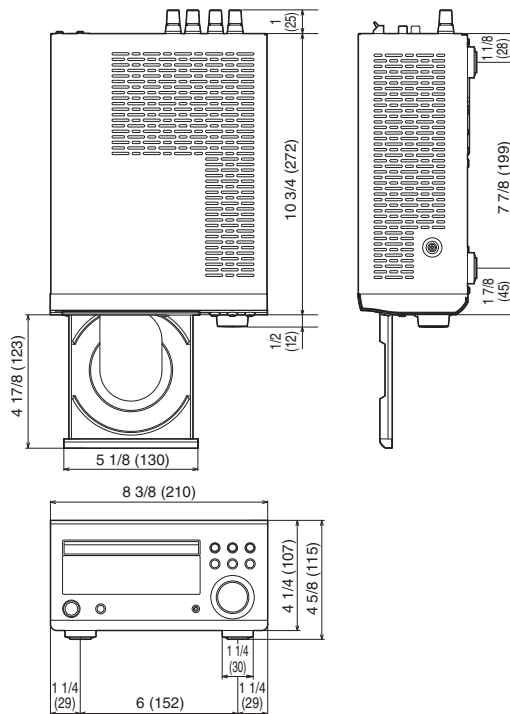

## ■ Weight : 9 lbs 4 oz (4.2 kg)

# Index

<b>A</b>	
Adjusting the tone .....	42
Alarm .....	47
Auto Standby .....	49
<b>B</b>	
Bluetooth device .....	35
<b>C</b>	
CD .....	27
<b>D</b>	
FM/AM broadcasts .....	21, 31
DATA CD .....	29
Display's brightness .....	44
<b>F</b>	
Front panel .....	8
<b>M</b>	
Menu map .....	45
Muting .....	26
<b>R</b>	
Rear panel .....	12
Remote control unit .....	14
Resetting factory settings .....	61
<b>S</b>	
Sleep timer .....	43
<b>V</b>	
Volume .....	26



**DENON**<sup>®</sup>

[www.denon.com](http://www.denon.com)

3520 10547 00AD

Copyright ©2017 D&M Holdings Inc. All Rights Reserved.