

# USER MANUAL

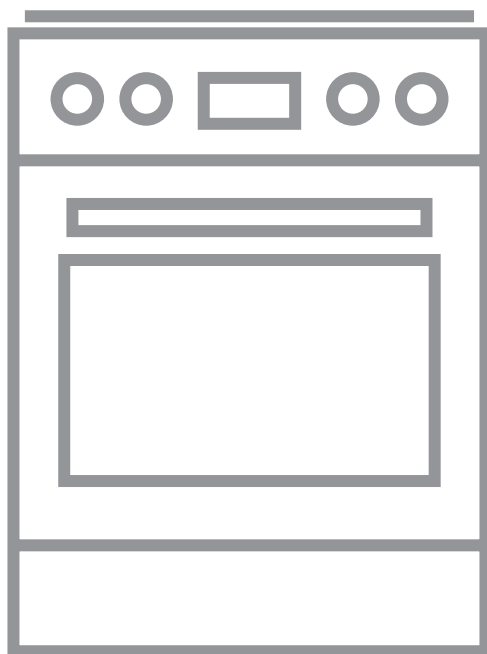

## CONTENTS

1. SAFETY INFORMATION.....	2
2. SAFETY INSTRUCTIONS.....	5
3. PRODUCT DESCRIPTION.....	8
4. BEFORE FIRST USE.....	9
5. HOB - DAILY USE.....	9
6. HOB - HINTS AND TIPS.....	14
7. HOB - CARE AND CLEANING.....	15
8. OVEN - DAILY USE .....	16
9. OVEN - CLOCK FUNCTIONS.....	18
10. OVEN - HINTS AND TIPS.....	20
11. OVEN - CARE AND CLEANING.....	32
12. TROUBLESHOOTING.....	35
13. INSTALLATION.....	37
14. ENERGY EFFICIENCY.....	39

## FOR PERFECT RESULTS

Thank you for choosing this AEG product. We have created it to give you impeccable performance for many years, with innovative technologies that help make life simpler features you might not find on ordinary appliances. Please spend a few minutes reading to get the very best from it.

Visit our website for:



Get usage advice, brochures, trouble shooter, service information:

**[www.aeg.com/webselfservice](http://www.aeg.com/webselfservice)**



Register your product for better service:

**[www.registeraeg.com](http://www.registeraeg.com)**



Buy Accessories, Consumables and Original spare parts for your appliance:

**[www.aeg.com/shop](http://www.aeg.com/shop)**

## CUSTOMER CARE AND SERVICE

Always use original spare parts.

When contacting our Authorised Service Centre, ensure that you have the following data available: Model, PNC, Serial Number.

The information can be found on the rating plate.

 Warning / Caution-Safety information

 General information and tips

 Environmental information

Subject to change without notice.

### 1. SAFETY INFORMATION

Before the installation and use of the appliance, carefully read the supplied instructions. The

manufacturer is not responsible for any injuries or damages that are the result of incorrect installation or usage. Always keep the instructions in a safe and accessible location for future reference.

## 1.1 Children and vulnerable people safety



### **WARNING!**

Risk of suffocation, injury or permanent disability.

- This appliance can be used by children aged from 8 years and above and persons with reduced physical, sensory or mental capabilities or lack of experience and knowledge if they have been given supervision or instruction concerning the use of the appliance in a safe way and understand the hazards involved.
- Children between 3 and 8 years of age and persons with very extensive and complex disabilities shall be kept away unless continuously supervised.
- Children of less than 3 years of age should be kept away unless continuously supervised.
- Do not let children play with the appliance.
- Keep all packaging away from children and dispose of it appropriately.
- Keep children and pets away from the appliance when it operates or when it cools down. Accessible parts are hot.
- If the appliance has a child safety device, it should be activated.
- Children shall not carry out cleaning and user maintenance of the appliance without supervision.

## 1.2 General Safety

- Only a qualified person must install this appliance and replace the cable.
- This appliance must be connected to the mains with a H05VV-F type cable to withstand the temperature of the rear panel.

- This appliance is intended for use up to an altitude of 2000 m above sea level.
- This appliance is not intended to be used on a ships, boats or vessels.
- Do not install the appliance behind a decorative door in order to avoid overheating.
- Do not install the appliance on a platform.
- Do not operate the appliance by means of an external timer or separate remote-control system.
- **WARNING:** Unattended cooking on a hob with fat or oil can be dangerous and may result in fire.
- **NEVER** try to extinguish a fire with water, but switch off the appliance and then cover flame e.g. with a lid or a fire blanket.
- **CAUTION:** The cooking process has to be supervised. A short term cooking process has to be supervised continuously.
- **WARNING:** Danger of fire: Do not store items on the cooking surfaces.
- Do not use a steam cleaner to clean the appliance.
- Do not use harsh abrasive cleaners or sharp metal scrapers to clean the glass door or the glass of hinged lids of the hob since they can scratch the surface, which may result in shattering of the glass.
- Metallic objects such as knives, forks, spoons and lids should not be placed on the hob surface since they can get hot.
- If the glass ceramic surface / glass surface is cracked, switch off the appliance and unplug it from the mains. In case the appliance is connected to the mains directly using junction box, remove the fuse to disconnect the appliance from power supply. In either case contact the Authorised Service Centre.
- After use, switch off the hob element by its control and do not rely on the pan detector.
- **WARNING:** The appliance and its accessible parts become hot during use. Care should be taken to avoid touching heating elements.

- Always use oven gloves to remove or put in accessories or ovenware.
- Before maintenance cut the power supply.
- Ensure that the appliance is switched off before replacing the lamp to avoid the possibility of electric shock.
- If the mains power supply cable is damaged, it must be replaced by the manufacturer, its Authorised Service Centre or similarly qualified persons to avoid an electrical hazard.
- Be careful when you touch the storage drawer. It can get hot.
- To remove the shelf supports first pull the front of the shelf support and then the rear end away from the side walls. Install the shelf supports in the opposite sequence.
- The means for disconnection must be incorporated in the fixed wiring in accordance with the wiring rules.
- **WARNING:** Use only hob guards designed by the manufacturer of the cooking appliance or indicated by the manufacturer of the appliance in the instructions for use as suitable or hob guards incorporated in the appliance. The use of inappropriate guards can cause accidents.

## 2. SAFETY INSTRUCTIONS

### 2.1 Installation



#### **WARNING!**

Only a qualified person must install this appliance.

- Remove all the packaging.
- Do not install or use a damaged appliance.
- Follow the installation instructions supplied with the appliance.
- Always take care when moving the appliance as it is heavy. Always use safety gloves and enclosed footwear.
- Do not pull the appliance by the handle.
- The kitchen cabinet and the recess must have suitable dimensions.
- Keep the minimum distance from other appliances and units.
- Install the appliance in a safe and suitable place that meets installation requirements.
- Parts of the appliance carry current. Close the appliance with furniture to prevent touching the dangerous parts.
- The sides of the appliance must stay next to appliances or units with the same height.
- Do not install the appliance adjacent to a door or under a window. This prevents hot cookware to fall from the

appliance when the door or the window is opened.

- Make sure to install a stabilizing means in order to prevent tipping of the appliance. Refer to Installation chapter.

## 2.2 Electrical Connection



### **WARNING!**

Risk of fire and electric shock.

- All electrical connections should be made by a qualified electrician.
- The appliance must be earthed.
- Make sure that the parameters on the rating plate are compatible with the electrical ratings of the mains power supply.
- Always use a correctly installed shockproof socket.
- Do not use multi-plug adapters and extension cables.
- Do not let mains cables touch or come near the appliance door, especially when the door is hot.
- The shock protection of live and insulated parts must be fastened in such a way that it cannot be removed without tools.
- Connect the mains plug to the mains socket only at the end of the installation. Make sure that there is access to the mains plug after the installation.
- If the mains socket is loose, do not connect the mains plug.
- Do not pull the mains cable to disconnect the appliance. Always pull the mains plug.
- Use only correct isolation devices: line protecting cut-outs, fuses (screw type fuses removed from the holder), earth leakage trips and contactors.
- The electrical installation must have an isolation device which lets you disconnect the appliance from the mains at all poles. The isolation device must have a contact opening width of minimum 3 mm.
- Fully close the appliance door, before you connect the mains plug to the mains socket.

## 2.3 Use



### **WARNING!**

Risk of injury and burns.  
Risk of electrical shock.

- This appliance is for household use only.
- Do not change the specification of this appliance.
- Make sure that the ventilation openings are not blocked.
- Do not let the appliance stay unattended during operation.
- Deactivate the appliance after each use.
- Be careful when you open the appliance door while the appliance is in operation. Hot air can release.
- Do not operate the appliance with wet hands or when it has contact with water.
- Do not use the appliance as a work surface or as a storage surface.
- Users with a pacemaker must keep a distance of minimum 30 cm from the induction cooking zones when the appliance is in operation.



### **WARNING!**

Risk of fire and explosion

- Fats and oil when heated can release flammable vapours. Keep flames or heated objects away from fats and oils when you cook with them.
- The vapours that very hot oil releases can cause spontaneous combustion.
- Used oil, that can contain food remnants, can cause fire at a lower temperature than oil used for the first time.
- Do not put flammable products or items that are wet with flammable products in, near or on the appliance.
- Do not let sparks or open flames to come in contact with the appliance when you open the door.
- Open the appliance door carefully. The use of ingredients with alcohol can cause a mixture of alcohol and air.



### **WARNING!**

Risk of damage to the appliance.

- To prevent damage or discoloration to the enamel:
  - do not put ovenware or other objects in the appliance directly on the bottom.
  - do not put water directly into the hot appliance.
  - do not keep moist dishes and food in the appliance after you finish the cooking.
  - be careful when you remove or install the accessories.
- Discoloration of the enamel or stainless steel has no effect on the performance of the appliance.
- Use a deep pan for moist cakes. Fruit juices cause stains that can be permanent.
- Do not keep hot cookware on the control panel.
- Do not let cookware boil dry.
- Be careful not to let objects or cookware fall on the appliance. The surface can be damaged.
- Do not activate the cooking zones with empty cookware or without cookware.
- Do not put aluminium foil on the appliance or directly on the bottom of the appliance.
- Cookware made of cast iron, aluminium or with a damaged bottom can cause scratches. Always lift these objects up when you have to move them on the cooking surface.
- This appliance is for cooking purposes only. It must not be used for other purposes, for example room heating.

## 2.4 Care and Cleaning



### **WARNING!**

Risk of injury, fire, or damage to the appliance.

- Before maintenance, deactivate the appliance.  
Disconnect the mains plug from the mains socket.
- Make sure the appliance is cold.  
There is the risk that the glass panels can break.
- Replace immediately the door glass panels when they are damaged.

Contact the Authorised Service Centre.

- Be careful when you remove the door from the appliance. The door is heavy!
- Fat and food remaining in the appliance can cause fire.
- Clean regularly the appliance to prevent the deterioration of the surface material.
- Make sure the cavity and the door are wiped dry after each use. Steam produced during the operation of the appliance condensates on cavity walls and can cause corrosion. To decrease the condensation operate the appliance for 10 minutes before cooking.
- Clean the appliance with a moist soft cloth. Only use neutral detergents. Do not use any abrasive products, abrasive cleaning pads, solvents or metal objects.
- If you use an oven spray, obey the safety instructions on the packaging.
- Do not clean the catalytic enamel (if applicable) with any kind of detergent.

## 2.5 Internal lighting



### **WARNING!**

Risk of electric shock.

- The type of light bulb or halogen lamp used for this appliance is for household appliances only. Do not use it for house lighting.
- Before replacing the lamp, disconnect the appliance from the power supply.
- Only use lamps with the same specifications.

## 2.6 Service

- To repair the appliance contact an Authorised Service Centre.
- Use original spare parts only.

## 2.7 Disposal



### **WARNING!**

Risk of injury or suffocation.

- Disconnect the appliance from the mains supply.

- Cut off the mains electrical cable close to the appliance and dispose of it.
- Remove the door catch to prevent children or pets from becoming trapped in the appliance.

## 3. PRODUCT DESCRIPTION

### 3.1 General overview

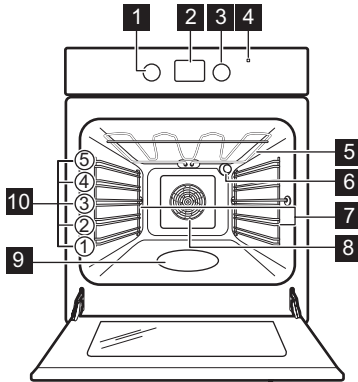

- 1 Knob for the heating functions
- 2 Display
- 3 Control knob (for the temperature)
- 4 Temperature indicator / symbol
- 5 Heating element
- 6 Lamp
- 7 Shelf support, removable
- 8 Fan
- 9 Cavity embossment
- 10 Shelf positions

### 3.2 Cooking surface layout

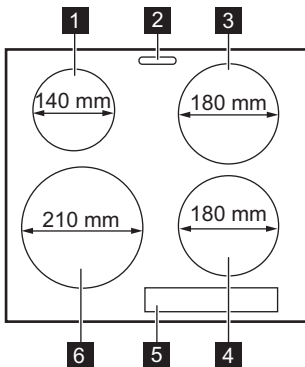

- 1 Induction cooking zone 1400 W with the PowerBoost 2500 W
- 2 Steam outlet - number and position depend on the model
- 3 Induction cooking zone 1800 W with the PowerBoost 2800 W
- 4 Induction cooking zone 1800 W with the PowerBoost 2800 W
- 5 Control panel
- 6 Induction cooking zone 2300 W with the PowerBoost 3600 W

### 3.3 Accessories

- **Wire shelf**  
For cookware, cake tins, roasts.
- **Baking tray**  
For cakes and biscuits.
- **Grill- / Roasting pan**

To bake and roast or as pan to collect fat.

- **Storage drawer**  
The storage drawer is below the oven cavity.



## 4. BEFORE FIRST USE



**WARNING!**  
Refer to Safety chapters.

### 4.1 Initial Cleaning

Remove all accessories and removable shelf supports from the oven.

Refer to "Care and cleaning" chapter.

Clean the oven and the accessories before the first use.

Put the accessories and the removable shelf supports back to their initial position.



### 4.2 Using the sensor fields

To activate a function touch and hold the selected symbol on the display for minimum 1 second.

### 4.3 Setting the time

You must set the time before you operate the oven.



The  flashes when you connect the appliance to the electrical supply, when there was a power cut or when the timer is not set.

Press the  or  to set the correct time.

After approximately five seconds, the flashing stops and the display shows the time of day you set.

### 4.4 Changing the time





You cannot change the time of day if the Duration  or End  function operates.

Press  again and again until the indicator for the Time of Day function flashes.

To set a new time, refer to "Setting the time".

### 4.5 Preheating

Preheat the empty oven before first use.

1. Set the function . Set the maximum temperature.
2. Let the oven operate for 1 hour.
3. Set the function . Set the maximum temperature.
4. Let the oven operate for 15 minutes.
5. Set the function . Set the maximum temperature.
6. Let the oven operate for 15 minutes.
7. Turn off the oven and let it cool down.

Accessories can become hotter than usual. The oven can emit an odour and smoke. Make sure that the airflow in the room is sufficient.

## 5. HOB - DAILY USE



**WARNING!**  
Refer to Safety chapters.

## 5.1 Hob control panel

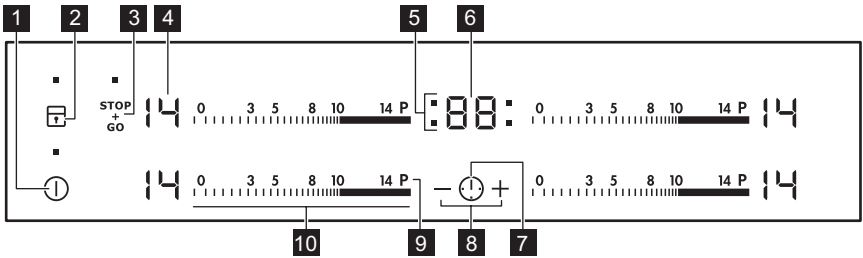

Use the sensor fields to operate the appliance. The displays, indicators and sounds tell which functions operate.

Sensor field	Function	Comment
1	ⓘ	ON / OFF To activate and deactivate the hob.
2	🔒	Lock / Child Safety Device To lock / unlock the control panel.
3	STOP + GO	STOP+GO To activate and deactivate the function.
4	-	Heat setting display To show the heat setting.
5	-	Timer indicators of cooking zones To show for which zone you set the time.
6	-	Timer display To show the time in minutes.
7	⌚	- To select the cooking zone.
8	+ / -	- To increase or decrease the time.
9	P	PowerBoost To activate and deactivate the function.
10	-	Control bar To set a heat setting.

## 5.2 Heat setting displays

Display	Description
⓪	The cooking zone is deactivated.
1 - 14	The cooking zone operates.
u	STOP+GO operates.
A	Automatic Heat Up operates.

Display	Description
	PowerBoost operates.
+ digit	There is a malfunction.
/  /	OptiHeat Control (3 step Residual heat indicator): continue cooking / keep warm / residual heat.
	Lock / Child Safety Device operates.
	Incorrect or too small cookware or no cookware on the cooking zone.
	Automatic Switch Off operates.

### 5.3 OptiHeat Control (3 step Residual heat indicator)



#### WARNING!

/ / There is a risk of burns from residual heat. The indicators show the level of the residual heat for the cooking zones you are currently using. The indicators may also come on for the neighbouring cooking zones even if you are not using them.

The induction cooking zones produce the heat necessary for the cooking process directly in the bottom of the cookware. The glass ceramic is heated by the heat of the cookware.

### 5.4 Activating and deactivating

Touch for 1 second to activate or deactivate the hob.

### 5.5 Automatic Switch Off

**The function deactivates the hob automatically if:**

- all cooking zones are deactivated,
- you do not set the heat setting after you activate the hob,
- you spill something or put something on the control panel for more than 10 seconds (a pan, a cloth, etc.). An acoustic signal sounds and the hob

deactivates. Remove the object or clean the control panel.

- the hob gets too hot (e.g. when a saucepan boils dry). Let the cooking zone cool down before you use the hob again.
- you use incorrect cookware. The symbol comes on and the cooking zone deactivates automatically after 2 minutes.
- you do not deactivate a cooking zone or change the heat setting. After some time comes on and the hob deactivates.

**The relation between the heat setting and the time after which the hob deactivates:**

Heat setting	The hob deactivates after
1 - 3	6 hours
4 - 7	5 hours
8 - 9	4 hours
10 - 14	1.5 hour

### 5.6 The heat setting

To set or change the heat setting:

Touch the control bar at the correct heat setting or move your finger along the control bar until you reach the correct heat setting.

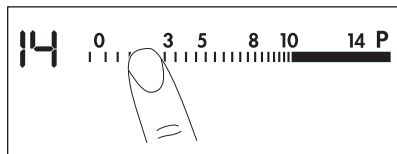

## 5.7 Automatic Heat Up

Activate this function to get a desired heat setting in a shorter time. When it is on, the zone operates on the highest setting in the beginning and then continues to cook at the desired heating setting.

**i** To activate the function the cooking zone must be cold.

**To activate the function for a cooking zone:** touch **P** (**P** comes on). Immediately touch a desired heat setting. After 3 seconds (**R**) comes on.

**To deactivate the function:** change the heat setting.

## 5.8 PowerBoost

This function makes more power available to the induction cooking zones. The function can be activated for the induction cooking zone only for a limited period of time. After this time the induction cooking zone automatically sets back to the highest heat setting.

**To activate the function for a cooking zone:** touch **P**. (**P**) comes on.

**To deactivate the function:** change the heat setting.

## 5.9 Timer

### Count Down Timer

You can use this function to set how long the cooking zone should operate for a single cooking session.

First set the heat setting for the cooking zone then set the function.

**To set the cooking zone:** touch **⏸** again and again until the indicator of a necessary cooking zone comes on.

**To activate the function:** touch **+** of the timer to set the time (00 - 99 minutes). When the indicator of the cooking zone starts to flash slowly the time counts down.

**To see the remaining time:** set the cooking zone with **⏸**. The indicator of the cooking zone starts to flash quickly. The display shows the remaining time.

**To change the time:** set the cooking zone with **⏸**. Touch **+** or **-**.

**To deactivate the function:** set the cooking zone with **⏸** and touch **-**. The remaining time counts back to 00. The indicator of the cooking zone goes out.

**i** When the time comes to an end, the sound operates and 00 flashes. The cooking zone deactivates.

**To stop the sound:** touch **⏸**.

### CountUp Timer (The count up timer)

You can use this function to monitor how long the cooking zone operates.

**To set the cooking zone:** touch **⏸** again and again until the indicator of a necessary cooking zone comes on.

**To activate the function:** touch **-** of the timer. **UP** comes on. When the indicator of the cooking zone starts to flash slowly the time counts up. The display switches between **UP** and counted time (minutes).

**To see how long the cooking zone operates:** set the cooking zone with **⏸**. The indicator of the cooking zone starts to flash quickly. The display shows how long the zone operates.



**To deactivate the function:** set the cooking zone with **⏸** and touch **+** or **-**. The indicator of the cooking zone goes out.

### Minute Minder

You can use this function as a **Minute Minder** when the hob is activated and

the cooking zones do not operate. The heat setting display shows .

**To activate the function:** touch .

Touch  or  of the timer to set the time. When the time comes to an end, the sound operates and **00** flashes.

**To stop the sound:** touch .

 The function has no effect on the operation of the cooking zones.

## 5.10 STOP+GO

This function sets all cooking zones that operate to the lowest heat setting.

When the function operates, you cannot change the heat setting.

The function does not stop the timer functions.



**To activate the function:** touch .  comes on.

**To deactivate the function:** touch . The previous heat setting comes on.

## 5.11 Lock

You can lock the control panel while cooking zones operate. It prevents an accidental change of the heat setting.

**Set the heat setting first.**

**To activate the function:** touch .  comes on for 4 seconds. The Timer stays on.



**To deactivate the function:** touch . The previous heat setting comes on.

 When you deactivate the hob, you also deactivate this function.



## 5.12 Child Safety Device

This function prevents an accidental operation of the hob.



**To activate the function:** activate the hob with . Do not set the heat setting.

Touch  for 4 seconds.  comes on. Deactivate the hob with .





**To deactivate the function:** activate the hob with . Do not set the heat setting.



Touch  for 4 seconds.  comes on. Deactivate the hob with .

**To override the function for only one cooking time:** activate the hob with .

 comes on. Touch  for 4 seconds. **Set the heat setting in 10 seconds.** You can operate the hob. When you deactivate the hob with  the function operates again.

## 5.13 OffSound Control (Deactivating and activating the sounds)

Deactivate the hob. Touch  for 3 seconds. The display comes on and goes out. Touch  for 3 seconds.  or  comes on. Touch  of the timer to choose one of the following:

-  - the sounds are off
  -  - the sounds are on
- To confirm your selection wait until the hob deactivates automatically.

When the function is set to  you can hear the sounds only when:

- you touch 
- Minute Minder comes down
- Count Down Timer comes down
- you put something on the control panel.

## 5.14 Power management function

- Cooking zones are grouped according to the location and number of the phases in the hob. See the illustration.
- Each phase has a maximum electricity load.
- The function divides the power between cooking zones connected to the same phase.
- The function activates when the total electricity loading of the cooking

zones connected to a single phase is exceeded.

- The function decreases the power to the other cooking zones connected to the same phase.
- The heat setting display of the reduced zones changes between two levels.

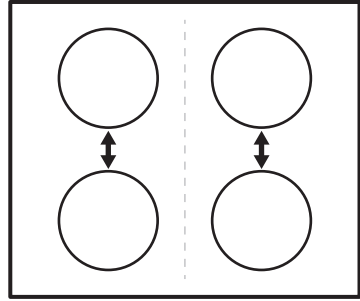

## 6. HOB - HINTS AND TIPS



**WARNING!**  
Refer to Safety chapters.

### 6.1 Cookware



For induction cooking zones a strong electro-magnetic field creates the heat in the cookware very quickly.



Use the induction cooking zones with suitable cookware.

#### Cookware material

- **correct:** cast iron, steel, enamelled steel, stainless steel, multi-layer bottom (with a correct marking from a manufacturer).
- **not correct:** aluminium, copper, brass, glass, ceramic, porcelain.

#### Cookware is suitable for an induction hob if:

- water boils very quickly on a zone set to the highest heat setting.
- a magnet pulls on to the bottom of the cookware.



The bottom of the cookware must be as thick and flat as possible. Ensure pan bases are clean and dry before placing on the hob surface.

#### Cookware dimensions

Induction cooking zones adapt to the dimension of the bottom of the cookware automatically.

The cooking zone efficiency is related to the diameter of the cookware. The cookware with a diameter smaller than the minimum receives only a part of the power generated by the cooking zone.

### 6.2 Minimum cookware diameter

Cooking zone	Cookware diameter (mm)
Left rear	125 - 140
Right rear	145 - 180
Right front	145 - 180
Left front	180 - 210

### 6.3 The noises during operation

#### If you can hear:

- crack noise: cookware is made of different materials (a sandwich construction).
- whistle sound: you use a cooking zone with a high power level and the cookware is made of different materials (a sandwich construction).
- humming: you use a high power level.
- clicking: electric switching occurs.
- hissing, buzzing: the fan operates.

**The noises are normal and do not indicate any malfunction.**

## 6.4 Examples of cooking applications

The correlation between the heat setting of a zone and its consumption of power is not linear. When you increase the heat setting, it is not proportional to the increase of the consumption of power. It

means that a cooking zone with the medium heat setting uses less than a half of its power.



The data in the table is for guidance only.

Heat setting	Use to:	Time (min)	Hints
1	Keep cooked food warm.	as necessary	Put a lid on the cookware.
1 - 3	Hollandaise sauce, melt: butter, chocolate, gelatine.	5 - 25	Mix from time to time.
1 - 3	Solidify: fluffy omelettes, baked eggs.	10 - 40	Cook with a lid on.
3 - 5	Simmer rice and milkbased dishes, heat up ready-cooked meals.	25 - 50	Add at least twice as much liquid as rice, mix milk dishes halfway through the procedure.
5 - 7	Steam vegetables, fish, meat.	20 - 45	Add a couple of tablespoons of liquid.
7 - 9	Steam potatoes.	20 - 60	Use max. ¼ l of water for 750 g of potatoes.
7 - 9	Cook larger quantities of food, stews and soups.	60 - 150	Up to 3 l of liquid plus ingredients.
9 - 12	Gentle fry: escalope, veal cordon bleu, cutlets, rissoles, sausages, liver, roux, eggs, pancakes, doughnuts.	as necessary	Turn halfway through.
12 - 13	Heavy fry, hash browns, loin steaks, steaks.	5 - 15	Turn halfway through.
14	Boil water, cook pasta, sear meat (goulash, pot roast), deep-fry chips.		
	Boil large quantities of water. PowerBoost is activated.		

## 7. HOB - CARE AND CLEANING



**WARNING!**  
Refer to Safety chapters.

### 7.1 General information

- Clean the hob after each use.

- Always use cookware with a clean base.
- Scratches or dark stains on the surface have no effect on how the hob operates.
- Use a special cleaner suitable for the surface of the hob.

- Use a special scraper for the glass.

## 7.2 Cleaning the hob

- **Remove immediately:** melted plastic, plastic foil, sugar and food with sugar, otherwise, the dirt can cause damage to the hob. Take care to avoid burns. Use a special hob scraper on the glass surface at an acute angle and move the blade on the surface.
- **Remove when the hob is sufficiently cool:** limescale rings, water rings, fat stains, shiny metallic discoloration. Clean the hob with a moist cloth and a non-abrasive detergent. After cleaning, wipe the hob dry with a soft cloth.
- **Remove shiny metallic discoloration:** use a solution of water with vinegar and clean the glass surface with a cloth.







## 8. OVEN - DAILY USE



### WARNING!

Refer to Safety chapters.

### 8.1 Oven functions

Symbol	Oven function	Application
0	Off position	The oven is off.
	True Fan Cooking	To bake on up to two shelf positions at the same time and to dry food. Set the temperature 20 - 40 °C lower than for Conventional Cooking.
	Pizza Setting	To bake food on one shelf position for a more intensive browning and a crispy bottom.
	Conventional Cooking	To bake and roast food on one shelf position.
	True Fan Cooking PLUS	To add humidity during the cooking. To get the right colour and crispy crust during baking. To give more juiciness during reheating.
	Fast Grilling	To grill flat food in large quantities and to toast bread.
	Turbo Grilling	To roast larger meat joints or poultry with bones on one shelf position. Also to make gratins and to brown.



Symbol	Oven function	Application
	Moist Fan Baking	This function is designed to save energy during cooking. For the cooking instructions refer to "Hints and tips" chapter, Moist Fan Baking. The oven door should be closed during cooking so that the function is not interrupted and to ensure that the oven operates with the highest energy efficiency possible. When you use this function, the temperature in the cavity may differ from the set temperature. The heating power may be reduced. For general energy saving recommendations refer to "Energy Efficiency" chapter, Energy Saving. This function was used to comply with the energy efficiency class according to EN 60350-1. When you use this function the lamp automatically turns off.

## 8.2 Activating and deactivating the oven



**It depends on the model if your appliance has knob symbols, indicators or lamps:**

- The indicator comes on when the oven heats up.
- The lamp comes on when the oven operates.
- The symbol shows whether the knob controls one of the cooking zones, the oven functions or the temperature.

1. Turn the knob for the oven functions to select an oven function.
2. Turn the knob for the temperature to select a temperature.
3. To deactivate the oven turn the knobs for the oven functions and temperature to the off position.

## 8.3 Activating the function: True Fan Cooking PLUS

This function allows to have an improvement of humidity during the cooking.



### **WARNING!**

Risk of burns and damage to the appliance.

Released humidity can cause burns:

- Do not open the appliance door when using the function: True Fan Cooking PLUS.
- Open the appliance door with care after using the function: True Fan Cooking PLUS.



Refer to "Hints and tips" chapter.

1. Open the oven door.
2. Fill the cavity embossment with tap water.  
The maximum capacity of the cavity embossment is 250 ml.  
Fill the cavity embossment with water only when the oven is cold.
3. Turn the knob for the function: True Fan Cooking PLUS .
4. Turn the knob for the temperature to select a temperature.
5. Put food in the appliance and close the oven door.



### **CAUTION!**

Do not refill the cavity embossment with water during cooking or when the oven is hot.

6. To deactivate the appliance, turn the knobs for the oven functions and temperature to the off position.
7. Remove water from the cavity embossment.

**WARNING!**

Make sure that the appliance is cool before you remove the remaining water from the cavity embossment.

## 8.4 Cooling fan

When the oven operates, the cooling fan turns on automatically to keep the surfaces of the oven cool. If you turn off the oven, the cooling fan can continue to operate until the oven cools down.

## 8.5 Inserting the oven accessories

### Deep pan:

Push the deep pan between the guide bars of the shelf support.

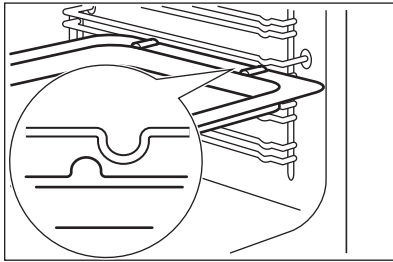

### Wire shelf and the deep pan together:

Push the deep pan between the guide bars of the shelf support and the wire shelf on the guide bars above.

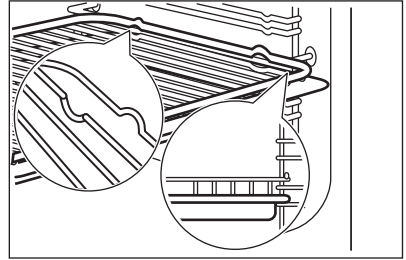

- All accessories have small indentations at the top of the right and left side to increase safety. The indentations are also anti-tip devices.
- The high rim around the shelf is a device which prevents cookware from slipping.

# 9. OVEN - CLOCK FUNCTIONS

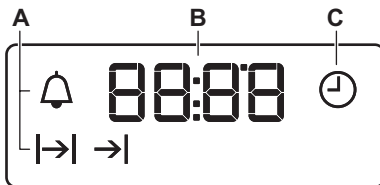

## 9.1 Display







- A. Clock functions  
B. Timer  
C. Clock function

## 9.2 Buttons





Button	Function	Description
—	MINUS	To set the time.

Button	Function	Description
	CLOCK	To set a clock function.
	PLUS	To set the time.

### 9.3 Clock functions table

Clock function	Application
 TIME OF DAY	To set, change or check the time of day.
 DURATION	To set how long the appliance operates.
 END	To set when the appliance deactivates.
 TIME DELAY	To combine DURATION and END function.
 MINUTE MINDER	To set countdown time. This function has no effect on the operation of the appliance. You can set the MINUTE MINDER at any time, also when the appliance is off.





### 9.4 Setting the DURATION

1. Set an oven function and temperature.
2. Press  again and again until  starts to flash.
3. Press  or  to set the DURATION time.

The display shows .

4. When the time ends,  flashes and an acoustic signal sounds. The appliance deactivates automatically.
5. Press any button to stop the acoustic signal.
6. Turn the knob for the oven functions and the knob for the temperature to the off position.









### 9.5 Setting the END

1. Set an oven function and temperature.
2. Press  again and again until  starts to flash.
3. Press  or  to set the time.

The display shows .

4. When the time ends,  flashes and an acoustic signal sounds. The appliance deactivates automatically.
5. Press any button to stop the signal.
6. Turn the knob for the oven functions and the knob for the temperature to the off position.

### 9.6 Setting the TIME DELAY



1. Set an oven function and temperature.
2. Press  again and again until  starts to flash.
3. Press  or  to set the time for DURATION.
4. Press .
5. Press  or  to set the time for END.
6. Press  to confirm.

Appliance turns on automatically later on, works for the set DURATION time and stops at the set END time. At the set time an acoustic signal sounds.

7. The appliance deactivates automatically. Press any button to stop the signal.

- Turn the knob for the oven functions and the knob for the temperature to the off position.

## 9.7 Setting the MINUTE MINDER

- Press  again and again until  starts to flash.
- Press **+** or **-** to set the necessary time.

The Minute Minder starts automatically after 5 seconds.

- When the set time ends, an acoustic signal sounds. Press any button to stop the acoustic signal.

- Turn the knob for the oven functions and the knob for the temperature to the off position.

## 9.8 Cancelling the clock functions

- Press the  again and again until the necessary function indicator starts to flash.

- Press and hold **-**.

The clock function goes out after some seconds.

# 10. OVEN - HINTS AND TIPS



### WARNING!

Refer to Safety chapters.



The temperature and baking times in the tables are guidelines only. They depend on the recipes and the quality and quantity of the ingredients used.

Always preheat an empty oven at the temperature required for the food for 20 minutes before you start cooking.

- You can extend baking times by 10 – 15 minutes if you bake cakes on more than one shelf position.
- Cakes and pastries at different heights do not always brown equally. There is no need to change the temperature setting if an unequal browning occurs. The differences equalize during baking.
- Trays in the oven can twist during baking. When the trays become cold again, the distortions disappear.

## 10.1 Baking

- Use the lower temperature the first time.

## 10.2 Tips on baking

Baking results	Possible cause	Remedy
The bottom of the cake is not browned sufficiently.	The shelf position is incorrect.	Put the cake on a lower shelf.

Baking results	Possible cause	Remedy
The cake sinks and becomes soggy, lumpy or streaky.	The oven temperature is too high.	The next time you bake, set a slightly lower oven temperature.
	The baking time is too short.	Set a longer baking time. You cannot decrease baking times by setting higher temperatures.
	There is too much liquid in the mixture.	Use less liquid. Be careful with mixing times, especially if you use a mixing machine.
The cake is too dry.	The oven temperature is too low.	The next time you bake, set a higher oven temperature.
	The baking time is too long.	The next time you bake, set a shorter baking time.
The cake browns unevenly.	The oven temperature is too high and the baking time is too short.	Set a lower oven temperature and a longer baking time.
	The mixture is unevenly distributed.	Spread the mixture evenly on the baking tray.
The cake is not ready in the baking time given.	The oven temperature is too low.	The next time you bake, set a slightly higher oven temperature.

### 10.3 True Fan Cooking

#### Baking on one oven level

Baking in tins

Food	Temperature (°C)	Time (min)	Shelf position
Ring cake or brioche	150 - 160	50 - 70	2
Madeira cake / fruit cakes	140 - 160	50 - 90	1 - 2
Fatless sponge cake	150 - 160 <sup>1)</sup>	25 - 40	3
Flan base - sponge mixture	150 - 170	20 - 25	2

<sup>1)</sup> Preheat the oven.

Cakes / pastries / breads on baking trays

Food	Temperature (°C)	Time (min)	Shelf position
Cake with crumble topping (dry)	150 - 160	20 - 40	3
Fruit flans (made with yeast dough / sponge mixture) <sup>1)</sup>	150	35 - 55	3

Food	Temperature (°C)	Time (min)	Shelf position
Fruit flans made with short pastry	160 - 170	40 - 80	3

1) Use deep pan.

#### Biscuits

Food	Temperature (°C)	Time (min)	Shelf position
Short pastry biscuits	150 - 160	10 - 20	3
Short bread / Pastry Stripes	140	20 - 35	3
Biscuits made with sponge mixture	150 - 160	15 - 20	3
Pastries made with egg white, merin-gues	80 - 100	120 - 150	3
Macaroons	100 - 120	30 - 50	3
Biscuits made with yeast dough	150 - 160	20 - 40	3
Puff pastries	170 - 180 <sup>1)</sup>	20 - 30	3
Rolls	160 <sup>1)</sup>	10 - 35	3

1) Preheat the oven.

#### Bakes and gratins table

Food	Temperature (°C)	Time (min)	Shelf position
Baguettes topped with melted cheese	160 - 170 <sup>1)</sup>	15 - 30	1
Stuffed vegetables	160 - 170	30- 60	1

1) Preheat the oven.

### Multileveled Baking

#### Cakes / pastries / breads on baking trays

Food	Temperature (°C)	Time (min)	Shelf position
			2 positions
Cream puffs / Eclairs	160 - 180 <sup>1)</sup>	25 - 45	2 / 4
Dry streusel cake	150 - 160	30 - 45	2 / 4

1) Preheat the oven.

## Biscuits/small cakes / pastries / rolls

Food	Temperature (°C)	Time (min)	Shelf position
			2 positions
Short pastry biscuits	150 - 160	20 - 40	2 / 4
Short bread / Pastry Stripes	140	25 - 45	2 / 4
Biscuits made with sponge mixture	160 - 170	25 - 40	2 / 4
Biscuits made with egg white, meringues	80 - 100	130 - 170	2 / 4
Macaroons	100 - 120	40 - 80	2 / 4
Biscuits made with yeast dough	160 - 170	30 - 60	2 / 4
Puff pastries	170 - 180 <sup>1)</sup>	30 - 50	2 / 4
Rolls	180 <sup>1)</sup>	25 - 40	2 / 4

<sup>1)</sup> Preheat the oven.

## 10.4 Conventional Baking on one level

### Baking in tins

Food	Temperature (°C)	Time (min)	Shelf position
Ring cake or brioche	160 - 180	50 - 70	2
Madeira cake / Fruit cakes	150 - 170	50 - 90	1 - 2
Flan base - short pastry	190 - 210 <sup>1)</sup>	10 - 25	2
Flan base - sponge mixture	170 - 190	20 - 25	2
Savoury flan (e. g, quiche lorraine)	180 - 220	35 - 60	1
Cheesecake	160 - 180	60 - 90	1 - 2

<sup>1)</sup> Preheat the oven.

### Cakes / pastries / breads on baking trays

Food	Temperature (°C)	Time (min)	Shelf position
Plaited bread / Bread crown	170 - 190	40 - 50	2
Christmas stollen	160 - 180 <sup>1)</sup>	50 - 70	2
Bread (rye bread): 1. First part of baking process. 2. Second part of baking process.	1. 230 <sup>1)</sup> 2. 160 - 180 <sup>1)</sup>	1. 20 2. 30 - 60	1 - 2

Food	Temperature (°C)	Time (min)	Shelf position
Cream puffs / Eclairs	190 - 210 <sup>1)</sup>	20 - 35	3
Swiss roll	180 - 200 <sup>1)</sup>	10 - 20	3
Cake with crumble topping (dry)	160 - 180	20 - 40	3
Buttered almond cake / Sugar cakes	190 - 210 <sup>1)</sup>	20 - 30	3
Fruit flans (made with yeast dough / sponge mixture) <sup>2)</sup>	170	35 - 55	3
Fruit flans made with short pastry	170 - 190	40 - 60	3
Yeast cakes with delicate toppings (e.g. quark, cream, custard)	160 - 180 <sup>1)</sup>	40 - 80	3
Unleavened bread	230 - 250	10 - 15	1
Tarts (CH)	210 - 230	35 - 50	1

<sup>1)</sup> Preheat the oven.

<sup>2)</sup> Use deep pan.

#### Biscuits

Food	Temperature (°C)	Time (min)	Shelf position
Short pastry biscuits	170 - 190	10 - 20	3
Short bread / Pastry Stripes	160 <sup>1)</sup>	20 - 35	3
Biscuits made with sponge dough	170 - 190	20 - 30	3
Pastries made with egg white, meringues	80 - 100	120 - 150	3
Macaroons	120 - 130	30 - 60	3
Biscuits made with yeast dough	170 - 190	20 - 40	3
Puff pastries	190 - 210 <sup>1)</sup>	20 - 30	3
Rolls	190 - 210 <sup>1)</sup>	10 - 55	3

<sup>1)</sup> Preheat the oven.

#### Bakes and gratins table

Food	Temperature (°C)	Time (min)	Shelf position
Pasta bake	180 - 200	45 - 60	1
Lasagne	180 - 200	35 - 50	1



Food	Temperature (°C)	Time (min)	Shelf position
Vegetables au gratin	180 - 200 <sup>1)</sup>	15 - 30	1
Baguettes topped with melted cheese	200 - 220 <sup>1)</sup>	15 - 30	1
Sweet bakes	180 - 200	40 - 60	1
Fish bakes	180 - 200	40 - 60	1
Stuffed vegetables	180 - 200	40 - 60	1

<sup>1)</sup> Preheat the oven.

## 10.5 Pizza Setting

Food	Temperature (°C)	Time (min)	Shelf position
Pizza (thin crust) <sup>1)</sup>	200 - 230 <sup>2)</sup>	10 - 20	1 - 2
Pizza (with a lot of topping) <sup>1)</sup>	180 - 200	20 - 35	1 - 2
Tarts	170 - 200	35 - 55	1 - 2
Spinach flan	160 - 180	45 - 60	1 - 2
Quiche Lorraine (Savoury flan)	170 - 190	45 - 55	1 - 2
Swiss Flan	170 - 200	35 - 55	1 - 2
Cheesecake	140 - 160	60 - 90	1 - 2
Vegetable pie	160 - 180	50 - 60	1 - 2
Unleavened bread	230 - 250 <sup>2)</sup>	10 - 20	2 - 3
Puff pastry flan	160 - 180 <sup>2)</sup>	45 - 55	2 - 3
Flammekuchen	230 - 250 <sup>2)</sup>	12 - 20	2 - 3
Piroggen (Russian version of calzone)	180 - 200 <sup>2)</sup>	15 - 25	2 - 3

<sup>1)</sup> Use deep pan.

<sup>2)</sup> Preheat the oven.

## 10.6 Moist Fan Baking

### Bread and pizza

Food	Temperature (°C)	Time (min)	Shelf position
Buns	180	25 - 35	3
Frozen pizza 350 g	190	25 - 35	3

### Cakes in baking tray

Food	Temperature (°C)	Time (min)	Shelf position
Swiss roll	180	20 - 30	3
Brownie	180	30 - 40	3

### Cakes in tin

Food	Temperature (°C)	Time (min)	Shelf position
Soufflè	200	30 - 40	3
Sponge flan base	180	20 - 30	3
Victoria sandwich	150	25 - 35	3

### Fish

Food	Temperature (°C)	Time (min)	Shelf position
Fish in pouches 300 g	180	25 - 35	3
Whole fish 200 g	180	25 - 35	3
Fish fillet 300 g	180	25 - 35	3

### Meat

Food	Temperature (°C)	Time (min)	Shelf position
Meat in pouch 250 g	200	25 - 35	3
Meat skewers 500 g	200	30 - 40	3

### Small baked items

Food	Temperature (°C)	Time (min)	Shelf position
Cookies	180	25 - 35	3
Macaroons	160	25 - 35	3
Muffins	180	25 - 35	3

Food	Temperature (°C)	Time (min)	Shelf position
Savoury cracker	170	20 - 30	3
Short crust pastry biscuits	150	25 - 35	3
Tartelettes	170	15 - 25	3

## Vegetarian

Food	Temperature (°C)	Time (min)	Shelf position
Mixed vegetables in pouch 400 g	180	25 - 35	3
Omelette	200	20 - 30	3
Vegetables on tray 700 g	180	25 - 35	3

## 10.7 True Fan Cooking PLUS



## Bakery

Food	Temperature (°C)	Water in the cavity embossment (ml)	Preheating time (min)	Time (min)	Shelf position
White bread	180	150	10	30 - 40	2
Bread rolls	200	150	5	20 - 25	2
Focaccia	190	150	10	20 - 25	1
Homemade pizza	230	150	10	15 - 20	2
Cookies, scones, croissant	160	150	10	10 - 20	2
Plum cake, cinnamon rolls	160	150	10	70 - 80	2

## Frozen foods

Food	Temperature (°C)	Water in the cavity embossment (ml)	Preheating time (min)	Time (min)	Shelf position
Pizza	200	100	10	15	2
Croissant	170	50	10	25	2
Lasagne	200	200	10	35 - 45	2

## Food regeneration

Food	Temperature (°C)	Water in the cavity embossment (ml)	Preheating time (min)	Time (min)	Shelf position
White bread	110	100	-	30 - 40	2
Bread rolls	110	100	-	20 - 25	2
Homemade pizza	110	100	-	15 - 20	2
Focaccia	110	100	-	20 - 30	2
Vegetables	110	100	-	15 - 25	2
Rice	110	100	-	15 - 26	2
Pasta	110	100	-	15 - 27	2
Meat	110	100	-	15 - 28	2

## Roasting

Food	Temperature (°C)	Water in the cavity embossment (ml)	Preheating time (min)	Time (min)	Shelf position
Chicken	210	200	-	70 - 75	2
Half chicken	210	200	-	35 - 50	2
Roast pork	180	200	-	65 - 70	2
Roast beef 1 - 1,5 kg	200	200	-	1. 50 - 55 2. 60 - 65 3. 65 - 70	2
1. Rare 2. Medium 3. Well done					
Roast turkey	200	200	-	70 - 85	2

## 10.8 Roasting

Use heat-resistant ovenware.

Roast large roasting joints directly in the tray or on the wire shelf placed above the tray.

Put some water in the tray to prevent the meat juices or fat from burning.

Meat with crackling can be roasted in the roasting tin without the lid.

Turn the roast after 1/2 - 2/3 of the cooking time.

To keep meat more succulent:

- roast lean meat in the roasting tin with the lid or use roasting bag.
- roast meat and fish in large pieces (1 kg or more).
- baste large roasts and poultry with their juices several times during roasting.

## 10.9 Conventional Roasting

### Beef

Food	Quantity	Temperature (°C)	Time (min)	Shelf position
Pot roast	1 - 1.5 kg	200 - 230	105 - 150	1

### Pork

Food	Quantity	Temperature (°C)	Time (min)	Shelf position
Shoulder, neck, ham joint	1 - 1.5 kg	210 - 220	90 - 120	1
Chop, spare rib	1 - 1.5 kg	180 - 190	60 - 90	1
Meat loaf	750 g - 1 kg	170 - 190	50 - 60	1
Pork knuckle (pre-cooked)	750 g - 1 kg	200 - 220	90 - 120	1

### Veal

Food	Quantity	Temperature (°C)	Time (min)	Shelf position
Roast veal <sup>1)</sup>	1 kg	210 - 220	90 - 120	1
Knuckle of veal	1.5 - 2 kg	200 - 220	150 - 180	1

<sup>1)</sup> Use a closed roasting dish.

### Lamb

Food	Quantity	Temperature (°C)	Time (min)	Shelf position
Leg of lamb, roast lamb	1 - 1.5 kg	210 - 220	90 - 120	1
Saddle of lamb	1 - 1.5 kg	210 - 220	40 - 60	1

### Game

Food	Quantity	Temperature (°C)	Time (min)	Shelf position
Saddle of hare, leg of hare	up to 1 kg	220 - 240 <sup>1)</sup>	30 - 40	1
Saddle of venison	1.5 - 2 kg	210 - 220	35 - 40	1
Haunch of venison	1.5 - 2 kg	200 - 210	90 - 120	1

<sup>1)</sup> Preheat the oven.

## Poultry

Food	Quantity	Temperature (°C)	Time (min)	Shelf position
Poultry portions	200 - 250 g each	220 - 250	20 - 40	1
Duck	1.5 - 2 kg	210 - 220	80 - 100	1
Goose	3.5 - 5 kg	200 - 210	150 - 180	1
Turkey	2.5 - 3.5 kg	200 - 210	120 - 180	1
Turkey	4 - 6 kg	180 - 200	180 - 240	1

## Fish

Food	Quantity	Temperature (°C)	Time (min)	Shelf position
Whole fish	1 - 1.5 kg	210 - 220	40 - 70	1

## 10.10 Roasting with Turbo Grilling

## Pork

Food	Quantity	Temperature (°C)	Time (min)	Shelf position
Shoulder, neck, ham joint	1 - 1.5 kg	160 - 180	90 - 120	1
Chop, spare rib	1 - 1.5 kg	170 - 180	60 - 90	1
Meat loaf	750 g - 1 kg	160 - 170	50 - 60	1
Pork knuckle (pre-cooked)	750 g - 1 kg	150 - 170	90 - 120	1

## Veal

Food	Quantity	Temperature (°C)	Time (min)	Shelf position
Roast veal	1 kg	160 - 180	90 - 120	1
Knuckle of veal	1.5 - 2 kg	160 - 180	120 - 150	1

## Lamb

Food	Quantity	Temperature (°C)	Time (min)	Shelf position
Leg of lamb, roast lamb	1 - 1.5 kg	150 - 170	100 - 120	1
Saddle of lamb	1 - 1.5 kg	160 - 180	40 - 60	1

## Poultry

Food	Quantity	Temperature (°C)	Time (min)	Shelf position
Poultry portions	200 - 250 g each	200 - 220	30 - 50	1
Duck	1.5 - 2 kg	180 - 200	80 - 100	1
Goose	3.5 - 5 kg	160 - 180	120 - 180	1
Turkey	2.5 - 3.5 kg	160 - 180	120 - 150	1
Turkey	4 - 6 kg	140 - 160	150 - 240	1

## 10.11 Grilling in general

**WARNING!**

Always grill with the oven door closed.

- **Always grill with the maximum temperature setting.**
- Set the shelf into the shelf position as recommended in the grilling table.
- Always set the deep pan to collect the fat into the first shelf position.

- Grill only flat pieces of meat or fish.

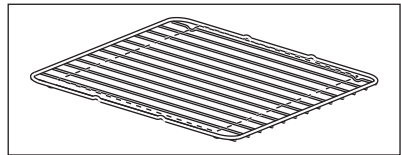

The grilling area is set in centre of the shelf.

## 10.12 Information for test institutes

Food	Function	Temperature (°C)	Time (min)	Accessories	Shelf position
Small cakes (20 small cakes per tray)	Conventional Cooking	170	20 - 30	Tray	3
Small cakes (20 small cakes per tray)	True Fan Cooking	150	20 - 35	Tray	3
Small cakes (20 small cakes per tray)	True Fan Cooking	150	20 - 40	Tray	1 / 4
Apple pie, 2 tins (ø 20 cm) on the grid, diagonally shifted	Conventional Cooking	180	70 - 90	Grid	1
Apple pie, 2 tins (ø 20 cm) on the grid, diagonally shifted	True Fan Cooking	160	70 - 90	Grid	2
Apple pie, 2 tins (ø 20 cm) on the grid, diagonally shifted	Pizza Setting	170	70 - 90	Grid	1

Food	Function	Temperature (°C)	Time (min)	Accessories	Shelf position
Apple pie, 2 tins (ø 20 cm) on the grid, diagonally shifted. <sup>1)</sup>	True Fan Cooking PLUS	160	70 - 80	Tray	2
Fatless sponge cake, 1 tin (ø 26 cm) on the grid	Conventional Cooking	160	30 - 45	Grid	3
Fatless sponge cake, 1 tin (ø 26 cm) on the grid	True Fan Cooking	150	30 - 45	Grid	2
Fatless sponge cake, 1 tin (ø 26 cm) on the grid	True Fan Cooking	150	30 - 50	Grid	1 / 4
Shortbread/Pastry strip	True Fan Cooking	140	20 - 35	Tray	3
Shortbread/Pastry strip	True Fan Cooking	140	25 - 45	Tray	1 / 4
Shortbread/Pastry strip	Conventional Cooking	160	20 - 35	Tray	3
Toast	Grilling	Max	5 - 9	Grid	4
Beef burger	Grilling	Max	15 - 20 first side. 10 - 15 second side.	Grid/Dripping pan	4

<sup>1)</sup> Add 150 ml of water to the cavity embossment.

## 11. OVEN - CARE AND CLEANING



### WARNING!

Refer to Safety chapters.

### 11.1 Notes on cleaning

Clean the front of the oven with a soft cloth with warm water and a mild cleaning agent.

To clean metal surfaces, use a dedicated cleaning agent.

Clean the oven interior after each use. Fat accumulation or other food remains may result in a fire. The risk is higher for the grill pan.

Clean all accessories after each use and let them dry. Use a soft cloth with warm water and a cleaning agent. Do not clean the accessories in the dishwasher.

Clean stubborn dirt with a special oven cleaner.

If you have nonstick accessories, do not clean them using aggressive agents, sharp-edged objects or a dishwasher. It can cause damage to the nonstick coating.

Clean the moisture from the cavity after each use.



## 11.2 Stainless steel or aluminium ovens

Clean the oven door with a damp cloth or sponge only. Dry it with a soft cloth.

Do not use steel wool, acids or abrasive materials as they can damage the oven surface. Clean the oven control panel with the same precautions.

## 11.3 Cleaning the cavity embossment

The cleaning procedure removes limestone residue from the cavity embossment after cooking with steam.

**i** For the function: True Fan Cooking PLUS we recommend to do the cleaning procedure at least every 5 - 10 cooking cycles.

1. Put 250 ml of white vinegar into the cavity embossment at the bottom of the oven.  
Use maximum 6% vinegar without any additives.
2. Let the vinegar dissolve the residual limestone at the ambient temperature for 30 minutes.
3. Clean the cavity with warm water and a soft cloth.

## 11.4 Removing the shelf supports

To clean the oven, remove the shelf supports.

1. Pull the front of the shelf support away from the side wall.

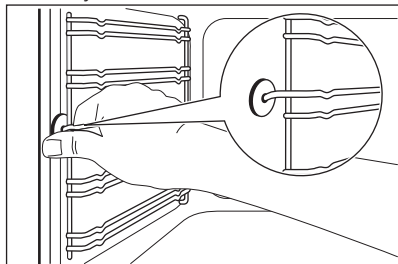

2. Pull the rear end of the shelf support away from the side wall and remove it.

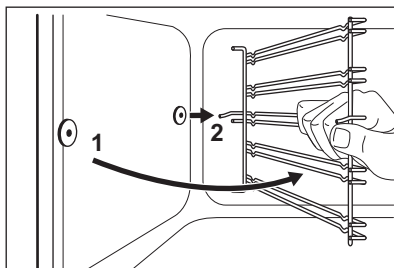

Install the shelf supports in the opposite sequence.



### CAUTION!

Make sure that the longer fixing wire is in the front. The ends of the two wires must point to the rear. Incorrect installation can cause damage to the enamel.

## 11.5 Removing the oven door

To make the cleaning easier, remove the door.

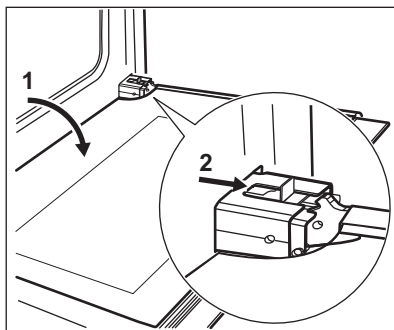

1. Open the door fully.
2. Move the slider until you hear a click.
3. Close the door until the slider locks.
4. Remove the door.  
To remove the door, pull the door outwards first from one side, and then the other.

When the cleaning procedure is completed, insert the oven door in the opposite sequence. Make sure that you hear a click when you insert the door. Use force if necessary.

## 11.6 Removing and cleaning the door glasses

**i** The door glass in your product can be different in type and shape from the examples you see in the images. The number of glasses can also be different.

1. Hold the door trim B on the top edge of the door at the two sides and push inwards to release the clip seal.

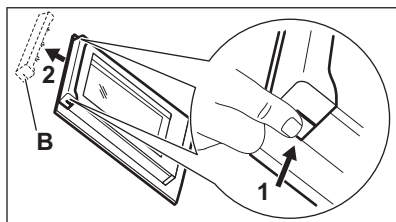

2. Pull the door trim to the front to remove it.
3. Hold the door glass panels on their top edge one by one and pull them upwards from the guide.

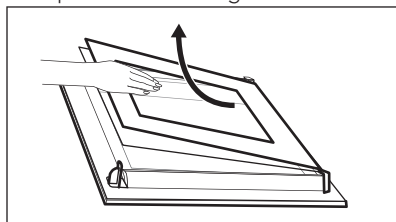

4. Clean the door glass panels. To install panels, do the same steps in reverse.

## 11.7 Replacing the lamp

**!** **WARNING!**  
Risk of electric shock.  
The lamp can be hot.

1. Turn off the oven. Wait until the oven is cooled down.
2. Disconnect the oven from the mains.
3. Put a cloth on the bottom of the cavity.

## The back lamp

**i** The lamp glass cover is at the back of the cavity.

1. Turn the lamp glass cover counterclockwise to remove it.
2. Clean the glass cover.
3. Replace the oven lamp with a suitable 300 °C heat-resistant oven lamp. Use the same oven lamp type.
4. Install the glass cover.

## 11.8 Removing the drawer

**!** **WARNING!**  
When the oven is in use, heat can build up in the drawer. Do not keep flammable things in there (e.g. cleaning materials, plastic bags, oven gloves, paper, cleaning sprays, etc.).

The drawer below the oven can be removed for cleaning.

1. Pull the drawer out until it stops.

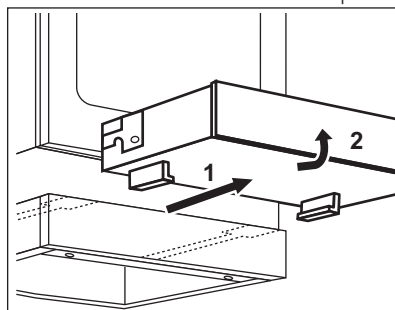

2. Lift the drawer at a small angle and remove it from the drawer support rails.

### Inserting the drawer:

1. To insert the drawer set the drawer on the support rails. Make sure that the catches engage correctly into the rails
2. Lower the drawer until it is horizontal and push it in.





## 12. TROUBLESHOOTING



**WARNING!**  
Refer to Safety chapters.

### 12.1 What to do if...

Problem	Possible cause	Remedy
You cannot activate the appliance.	The appliance is not connected to an electrical supply or it is connected incorrectly.	Check if the appliance is correctly connected to the electrical supply.
You cannot activate the appliance.	The fuse is blown.	Make sure that the fuse is the cause of the malfunction. If the fuse is blown again and again, contact a qualified electrician.
You cannot activate or operate the hob.	You touched 2 or more sensor fields at the same time.	Touch only one sensor field.
You cannot activate or operate the hob.	STOP+GO function operates.	Refer to "Hob - Daily use" chapter.
You cannot activate or operate the hob.	There is water or fat stains on the control panel.	Clean the control panel.
An acoustic signal sounds and the hob deactivates. An acoustic signal sounds when the hob is deactivated.	You put something on one or more sensor fields.	Remove the object from the sensor fields.
The hob deactivates.	You put something on the sensor field ①.	Remove the object from the sensor field.
Residual heat indicator does not come on.	The zone is not hot because it operated only for a short time.	If the zone operated sufficiently long to be hot, speak to an Authorised Service Centre.
Automatic Heat Up function does not operate.	The zone is hot.	Let the zone become sufficiently cool.
Automatic Heat Up function does not operate.	The highest heat setting is set.	The highest heat setting has the same power as the function.
The heat setting changes between two levels.	Power management function operates.	Refer to "Hob - Daily use" chapter.
The sensor fields become hot.	The cookware is too large or you put it too near to the controls.	Put large cookware on the rear zones if possible.

Problem	Possible cause	Remedy
There is no signal when you touch the panel sensor fields.	The signals are deactivated.	Activate the signals. Refer to "Hob - Daily use" chapter.
 comes on the hob display.	Automatic Switch Off operates.	Deactivate the hob and activate it again.
 comes on the hob display.	The Child Safety Device or the Lock function operates.	Refer to "Hob - Daily use" chapter.
 comes on the hob display.	There is no cookware on the zone.	Put cookware on the zone.
 comes on the hob display.	The cookware is incorrect.	Use the correct cookware. Refer to "Hob - Hints and tips" chapter.
 comes on the hob display.	The diameter of the bottom of the cookware is too small for the zone.	Use cookware with correct dimensions. Refer to "Hob - Hints and tips" chapter.
The oven does not heat up.	The oven is deactivated.	Activate the oven.
The oven does not heat up.	The clock is not set.	Set the clock.
The oven does not heat up.	The necessary settings are not set.	Make sure that the settings are correct.
The lamp does not operate.	The lamp is defective.	Replace the lamp.
The display shows "12.00".	There was a power cut.	Reset the clock.
Steam and condensation settle on the food and in the cavity of the oven.	You left the dish in the oven for too long.	Do not leave the dishes in the oven for longer than 15 - 20 minutes after the cooking process ends.
There is no good cooking performance using the True Fan Cooking PLUS function.	You did not fill the cavity embossment with water.	Refer to "Activating the True Fan Cooking PLUS function".
The water in the cavity embossment does not boil.	The temperature is too low.	Set the temperature at least to 110°C. Refer to "Hints and Tips" chapter.
The water comes out of the cavity embossment.	There is too much water in the cavity embossment.	Deactivate the oven and make sure that the appliance is cold. Wipe the water with a cloth or sponge. Add the correct amount of water to the cavity embossment. Refer to "Activating the True Fan Cooking PLUS function".

## 12.2 Service data

If you cannot find a solution to the problem yourself, contact your dealer or an Authorised Service Centre.

The necessary data for the service centre is on the rating plate. The rating plate is

on the front frame of the oven cavity. Do not remove the rating plate from the oven cavity.

We recommend that you write the data here:	
Model (MOD.)	.....
Product number (PNC)	.....
Serial number (S.N.)	.....

## 13. INSTALLATION



**WARNING!**  
Refer to Safety chapters.

### 13.1 Technical data

Dimensions	
Height	847 - 867 mm
Width	596 mm
Depth	600 mm

### 13.2 Location of the appliance

You can install your freestanding appliance with cabinets on one or two sides and in the corner.

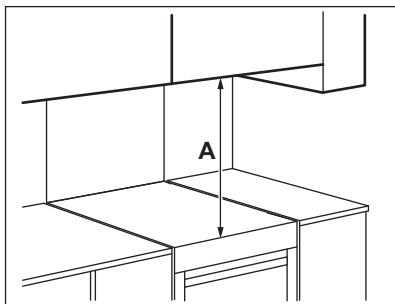

Minimum distances

Dimension	mm
A	685

### 13.3 Levelling of the appliance

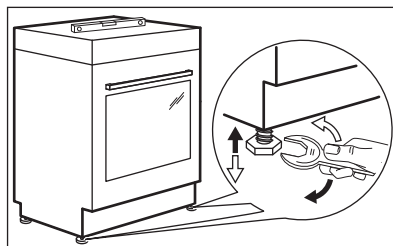

Use small feet on the bottom of appliance to set the appliance top surface level with other surfaces.

### 13.4 Anti-tilt protection

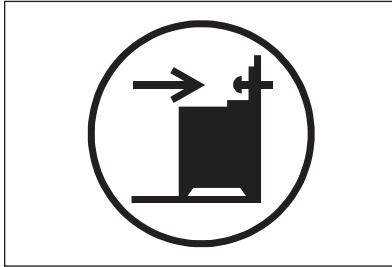

**CAUTION!**  
Install the anti-tilt protection to prevent the appliance from falling under incorrect loads. The anti-tilt protection only works when the appliance is put in a correct area.  
Your appliance has the symbols shown on the pictures (if applicable) to remind you about the installation of the anti-tilt protection.

**CAUTION!**

Make sure you install the anti-tilt protection at the correct height.

Make sure that the surface behind the appliance is smooth.

1. Set the correct height and area for the appliance before you attach the anti-tilt protection.
2. Install the anti-tilt protection 176 mm down from the top surface of the appliance and 24 mm from the left side of the appliance into the circular hole on the bracket. See the illustration. Screw it into the solid material or use applicable reinforcement (wall).
3. You can find the hole on the left side at the back of the appliance. See the illustration. Put the appliance in the middle of the space between the cupboards (1). If the space between the bench cupboards is larger than the width of the appliance, you must adjust the side measurement to centre the appliance.

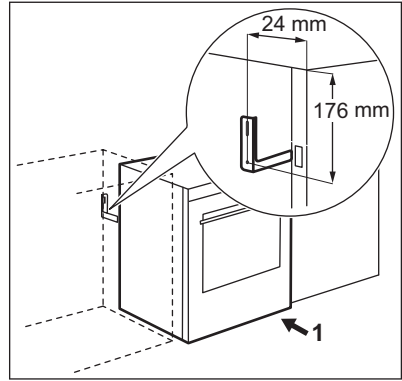
**13.5 Electrical installation****WARNING!**

The manufacturer is not responsible if you do not follow the safety precautions from Safety chapters.

This appliance is supplied without a main plug or a main cable.

Applicable types of cables for different phases:

Phase	Min. size cable
1	3x6.0 mm <sup>2</sup>
3 with neutral	5x1.5 mm <sup>2</sup>

**WARNING!**

The power cable must not touch the part of the appliance shaded in the illustration.

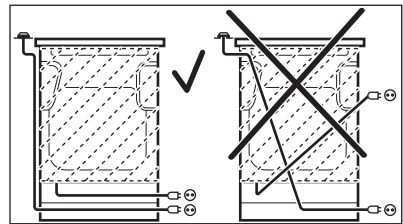

## 14. ENERGY EFFICIENCY

### 14.1 Product information for hob according to EU 66/2014

Model identification	CIB6640ABM	
Type of hob	Hob inside Freestanding Cooker	
Number of cooking zones	4	
Heating technology	Induction	
Diameter of circular cooking zones (Ø)	Left front	21.0 cm
	Left rear	14.0 cm
	Right front	18.0 cm
	Right rear	18.0 cm
Energy consumption per cooking zone (EC electric cooking)	Left front	173.2 Wh/kg
	Left rear	170.1 Wh/kg
	Right front	168.5 Wh/kg
	Right rear	165.7 Wh/kg
Energy consumption of the hob (EC electric hob)	169.4 Wh/kg	

EN 60350-2 - Household electric cooking appliances - Part 2: Hobs - Methods for measuring performance.

### 14.2 Hob - Energy saving

You can save energy during everyday cooking if you follow below hints.

- When you heat up water, use only the amount you need.
- If it is possible, always put the lids on the cookware.
- Before you activate the cooking zone put the cookware on it.
- Put the smaller cookware on the smaller cooking zones.
- Put the cookware directly in the centre of the cooking zone.
- Use the residual heat to keep the food warm or to melt it.

### 14.3 Product Fiche and information for ovens according to EU 65-66/2014

Supplier's name	AEG
Model identification	CIB6640ABM
Energy Efficiency Index	95.3
Energy efficiency class	A
Energy consumption with a standard load, conventional mode	0.95 kWh/cycle
Energy consumption with a standard load, fan-forced mode	0.82 kWh/cycle
Number of cavities	1
Heat source	Electricity

Volume	73 l
Type of oven	Oven inside Freestanding Cooker
Mass	51.6 kg

EN 60350-1 - Household electric cooking appliances - Part 1: Ranges, ovens, steam ovens and grills - Methods for measuring performance.

## 14.4 Oven - Energy saving



The oven contains features which help you save energy during everyday cooking.

### General hints

Make sure that the oven door is closed properly when the oven operates. Do not open the door too often during cooking. Keep the door gasket clean and make sure it is well fixed in its position.

Use metal dishes to improve energy saving.

When possible, do not preheat the oven before you put the food inside.

When the cooking duration is longer than 30 minutes, reduce the oven

temperature to minimum 3 - 10 minutes before the end of the cooking time, depending on the duration of the cooking. The residual heat inside the oven will continue to cook.

Use the residual heat to warm up other dishes.

Keep breaks between baking as short as possible when you prepare few dishes at one time.

### Cooking with fan

When possible, use the cooking functions with fan to save energy.

### Keep food warm

Choose the lowest possible temperature setting to use residual heat and keep a meal warm.

### Moist Fan Baking

Function designed to save energy during cooking.

## 15. ENVIRONMENTAL CONCERNS

Recycle materials with the symbol . Put the packaging in relevant containers to recycle it. Help protect the environment and human health by recycling waste of electrical and electronic appliances. Do not dispose of

appliances marked with the symbol  with the household waste. Return the product to your local recycling facility or contact your municipal office.









[www.aeg.com/shop](http://www.aeg.com/shop)



867 338550-C-462018



**AEG**