

16TCFR2000_Tunturi Cardio fit Row R20

Spare parts service document

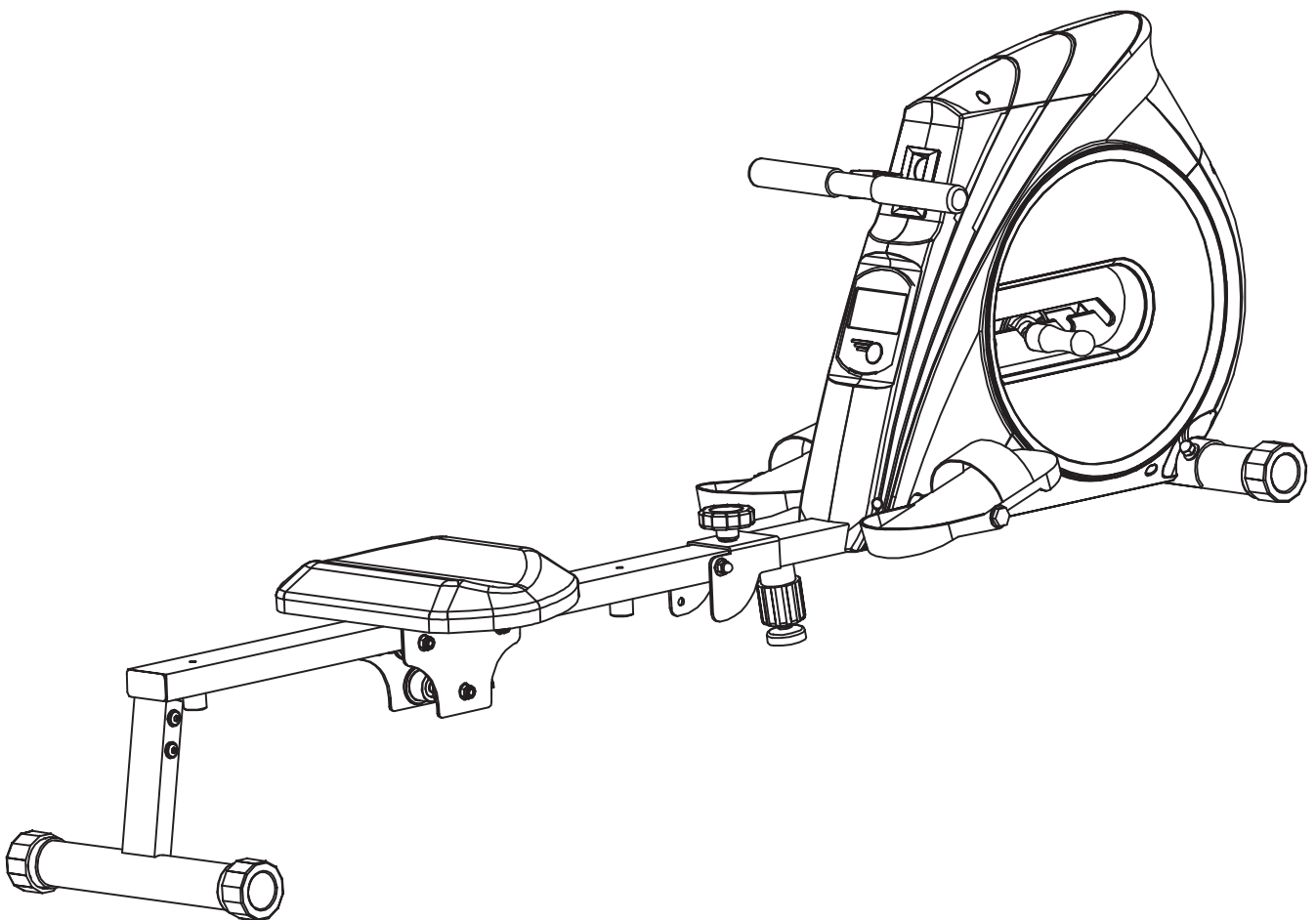

Extra document information

Document version : V. 1.2

Document release date : 07-11-2017

Valid for serialnumber range : XXX - XXX

Serial shown as XXX means still in production on document change date



Tunturi New Fitness BV

Purmerweg 1 NL - 1311 XE Almere
P.O. Box 60001 NL - 1320 AA Almere
The Netherlands

www.tunturi-fitness.com

Parts list

Buble	#	Description	Specification	Part number	Qty
1		Main frame		.103.5019	1
2		Front stabilizer		.103.5020	1
3		End cap		.533.0077	4
4	*	Bolt	M8x65	.601.0404	2
5	*	Arc washer	d8x1.5xØ20xR30	.625.0156	2
6	*	Spring washer D8		.625.0157	6
7	*	Nut	M8	.610.0080	2
8	*	Bolt	Ø12.5x130xM12x18		2
9	*	Flat washer	D13xØ26x2	.625.0158	4
10		Pedal	(incl strap)	.363.1006	2
11		Screw	ST4.2x18	.601.0406	10
12		Computer		.233.0065	1
13L		Chain cover (LH)		.173.4197	1
13R		Chain cover (RH)		.173.4198	1
14		Bolt	M8x62	.601.0407	4
15	*	Flat washer	D8xØ19x1.5	.625.0159	19
16		Bushing	Ø12xØ8.5x10.5	.523.0040	4
17		Bearing	608	.523.0041	4
18		Wheel		.523.0042	2
19		Idler wheel		.523.0043	2
20		Fixed sleeve		.523.0044	1
21		Nylon nut	M8	.610.0081	7
22		Handlebar		.203.6009	2
23		End cap		.173.4199	3
24		Axle	M10xØ12x95	.343.5012	1
25		Bearing	Ø32xØ12x11	.523.0045	2
26		Wheel		.523.0046	1
27		U-shaped washer		.625.0160	1
28		Rope lock		.503.1036	2
29		Plug		.503.1037	2
30		Handlebar		.203.6010	1
31		Foam grip		.173.4200	2
32		Rope		.443.0010	1
33		Bolt		.601.0408	1
34	*	Bolt	M10x80	.601.0409	1
35		Sensor wire		.403.5358	1
36		Extended wire		.403.5359	1
37	*	Flat washer D	10xØ20x1.5	.625.0161	2
38	*	Nut	M10	.610.0082	1
39		End cap		.173.4201	1
40		Adjustable foot pad		.533.0078	1
41		Cushion pad		.533.0079	2
42		Sensor		.403.5360	1
43		Screw	ST3x10	.601.0410	2
44		End cap		.173.4202	1
45		Rail tube		.103.5021	1



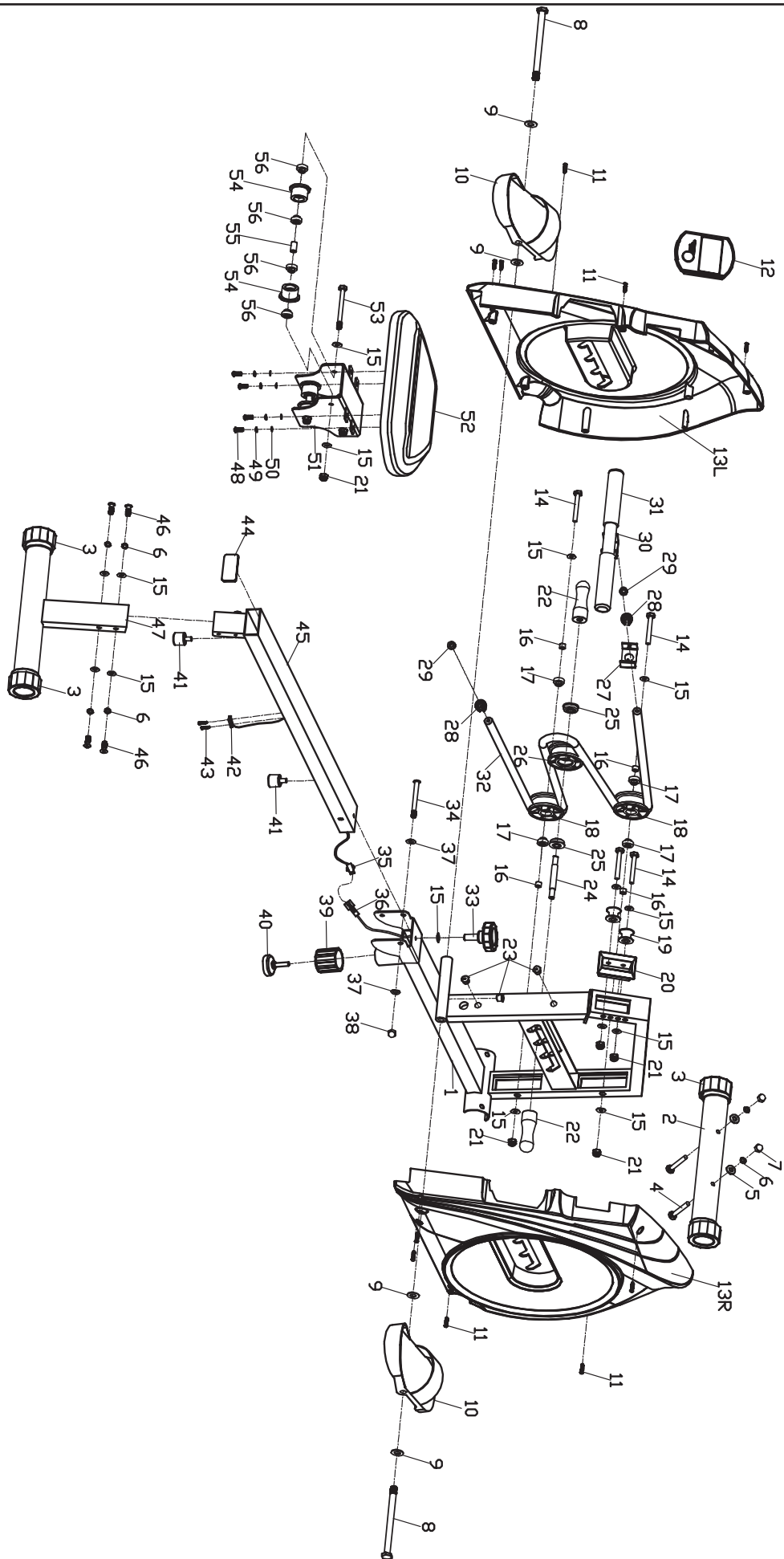













Buble	#	Description	Specification	Part number	Qty
46	*	Screw	M8x16	.601.0411	4
47		Rear support frame		.103.5022	1
48	*	Bolt	M6x15	.601.0412	4
49	*	Spring washer	Ø6	.625.0162	4
50	*	Flat washer	Ø6	.625.0163	4
51		Saddle post		.153.6014	1
52		Saddle		.153.6015	1
53		Bolt	M8x90	.601.0413	3
54		Wheel		.523.0047	6
55		Bushing	Ø12xØ8x20	.523.0048	3
56		Bearing		.523.0049	12
		Hardware kit		.553.0043	1

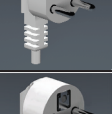

Additional service document information				
File version information			Document symbol explanation	
Gen.	1st. serial number known	latest serial number	~	up untill part ...
1	XXX	XXX	!	Corrected items
			&	Comes with an other part in list
			≠	DIN / ISO articles are not available as spare part
			*	Included in hardware kit

Generation 1

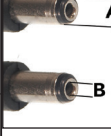
- Version 1.0 First production version.
- Version 1.1 Updated #10 Pedal incl strap. / Corrected part number fault #8
- Versoin 1.2 Add Hardware kit to parts list.

Power plug and socket type information							
	Power plug Type A		Power plug Type F		Power plug Type K		Power socket Type C7
	Power plug Type B		Power plug Type G		Power plug Type L		Power socket Type C13
	Power plug Type C		Power plug Type H		Power plug Type M		Power socket Type C19
	Power plug Type D		Power plug Type I		Power plug Type N	 <p>DC wire plug Type define: C: A=5.5 x B=2.5mm D: A=5.5 x B=2.1mm</p>	
	Power plug Type E		Power plug Type J				NOTE: Tunturi uses D type DC connectors only since 2006