

Marshall

ACTON II VOICE WITH THE GOOGLE ASSISTANT BUILT-IN

USER MANUAL

LEGAL & TRADEMARK NOTICE

- Design of device and packaging are intellectual properties of Zound Industries International AB and Marshall Amplification Plc. © All Rights Reserved. Zound Industries International AB is hereinafter referred to as “Zound Industries” or “manufacturer”.
- MARSHALL, Marshall Amps, their respective logos, “Marshall” and “Marshall” trade dress are trademarks and intellectual property of Marshall Amplification Plc and may not be used without permission. Permission granted to Zound Industries.
- Wi-Fi®, the Wi-Fi logo and the Wi-Fi CERTIFIED™ logo is a certification mark of Wi-Fi Alliance®.
- The Bluetooth® wordmark and logos are registered trademarks owned by the Bluetooth SIG, Inc. and any use of such marks by Zound Industries is under license.
- Google, Google Play, Google Assistant, Chromecast built in and their respective logos are trademarks of Google LLC.
- Apple and the Apple logo are trademarks of Apple Inc. registered in the U.S. and other countries. App Store is a service mark of Apple Inc., registered in the U.S. and other countries.
- All other trademarks are the property of their respective owners and may not be used without permission.

For more legal information related to this product and to its use in your specific region, and for more detailed information about Zound Industries and partner & license information, please visit the website: www.marshallheadphones.com. The user is recommended to visit the website regularly for up-to-date information.

Zound Industries International AB, Centralplan 15, 111 20 Stockholm, Sweden

DISCLAIMER

Please note that the availability of third party services, including but not limited to Chromecast built-in, Google Assistant, and this device's compatibility with the same, is subject to the respective rights holder's consent, which may be withdrawn, and supply of such services, which may be terminated, resulting in this device not being compatible with such third-party services, without any liabilities for Zound Industries.

The availability of third party services may need separate agreements between you and any third party and Zound Industries do not take responsibility for the availability of such services.

The information contained herein is correct at the time of publication, with reservation for editorial errors. This product is software dependent and its functions and compatibility can change when updating the software.

INDEX

ENGLISH

SECTIONS

PAGE

- 002. LEGAL & TRADEMARK NOTICE**
- 004. BOX CONTENTS**
- 005. GENERAL DESCRIPTION**
- 007. PLUGGING IN THE ACTON II VOICE**
- 008. SETTING UP THE ACTON II VOICE**
- 009. USING THE GOOGLE ASSISTANT BUILT-IN**
- 010. SELECTING AUDIO SOURCE**
- 011. USING ACTON II VOICE WITH CHROMECAST BUILT-IN**
- 012. CONNECTING VIA BLUETOOTH® (PAIRING)**
- 013. CONNECTING VIA AUX INPUT**
- 014. ADJUSTING THE VOLUME/BASS/TREBLE**
- 015. PLAY/PAUSE CONTROL**
- 016. MUTING/UNMUTING THE MICROPHONE**
- 017. TECHNICAL INFORMATION**
- 018. TROUBLESHOOTING**

BOX CONTENTS

- 001. MARSHALL ACTON II VOICE WITH THE GOOGLE ASSISTANT BUILT-IN**
- 002. QUICK START GUIDE**
- 003. IMPORTANT SAFETY INSTRUCTIONS**
- 004. MAINS LEAD**

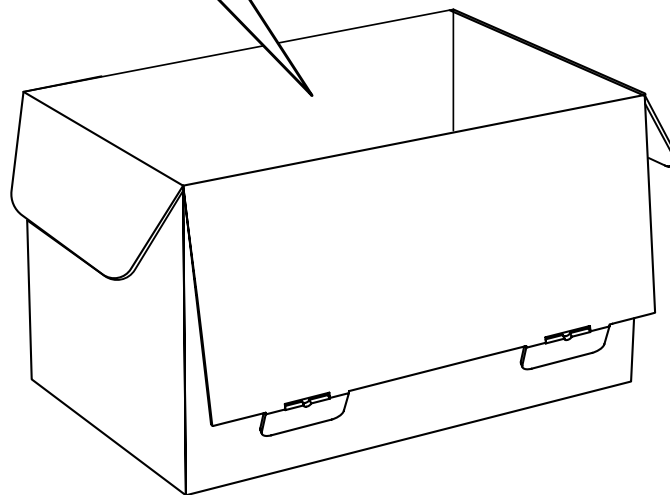
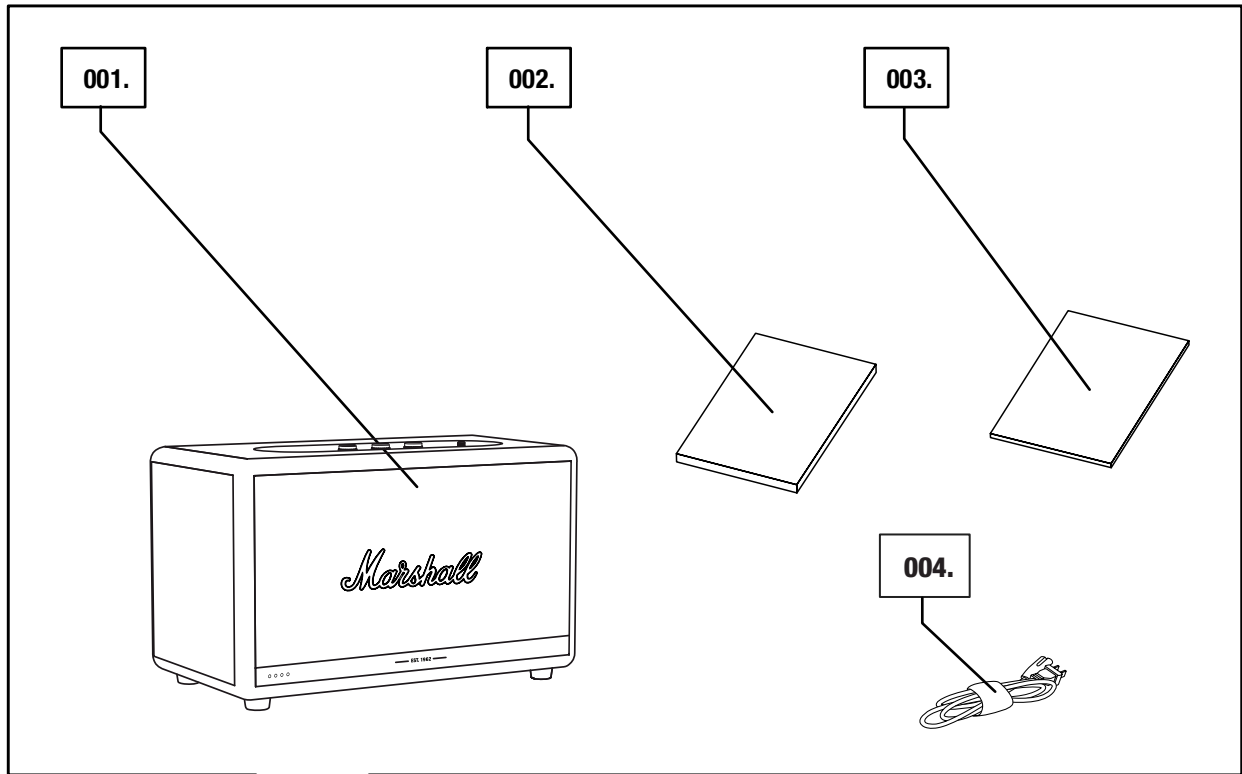

GENERAL DESCRIPTION

- 001. AUX INPUT FOR 3.5 mm JACK
- 002. SOURCE INDICATORS
- 003. SOURCE BUTTON
- 004. VOLUME KNOB
- 005. BASS KNOB
- 006. TREBLE KNOB
- 007. MICROPHONES
- 008. PLAY/PAUSE BUTTON
- 009. MICROPHONE BUTTON

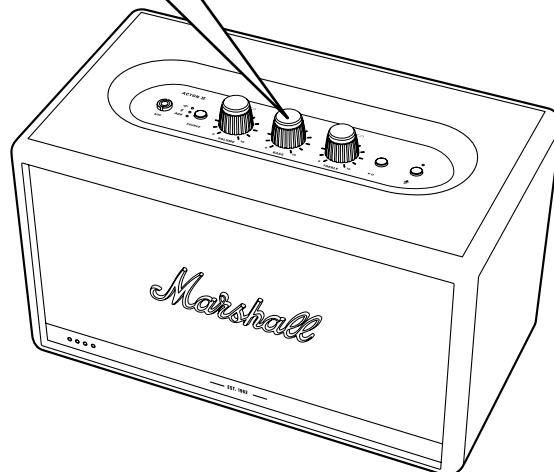
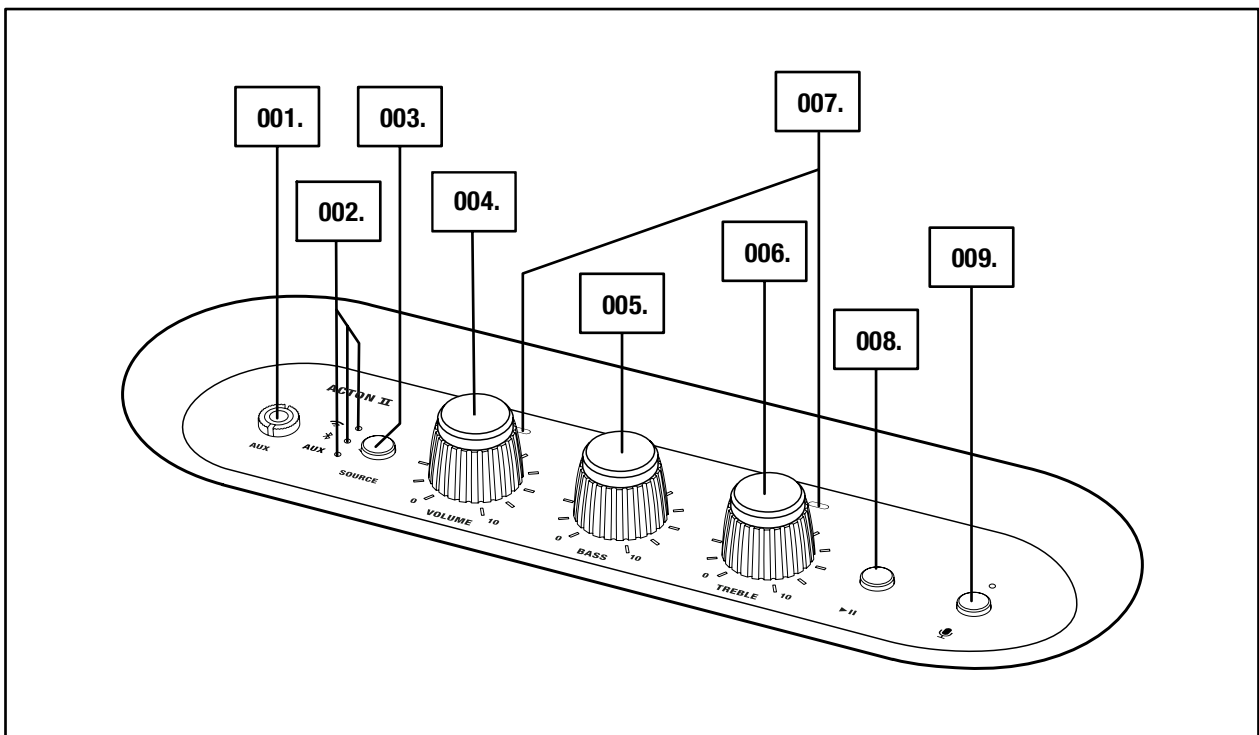

005.

Marshall

GENERAL DESCRIPTION CONTINUED

- 009. BASS PORT
- 010. BACKPLATE
- 011. USB SERVICE PORT
- 012. MAINS INPUT
- 013. MAINS LEAD

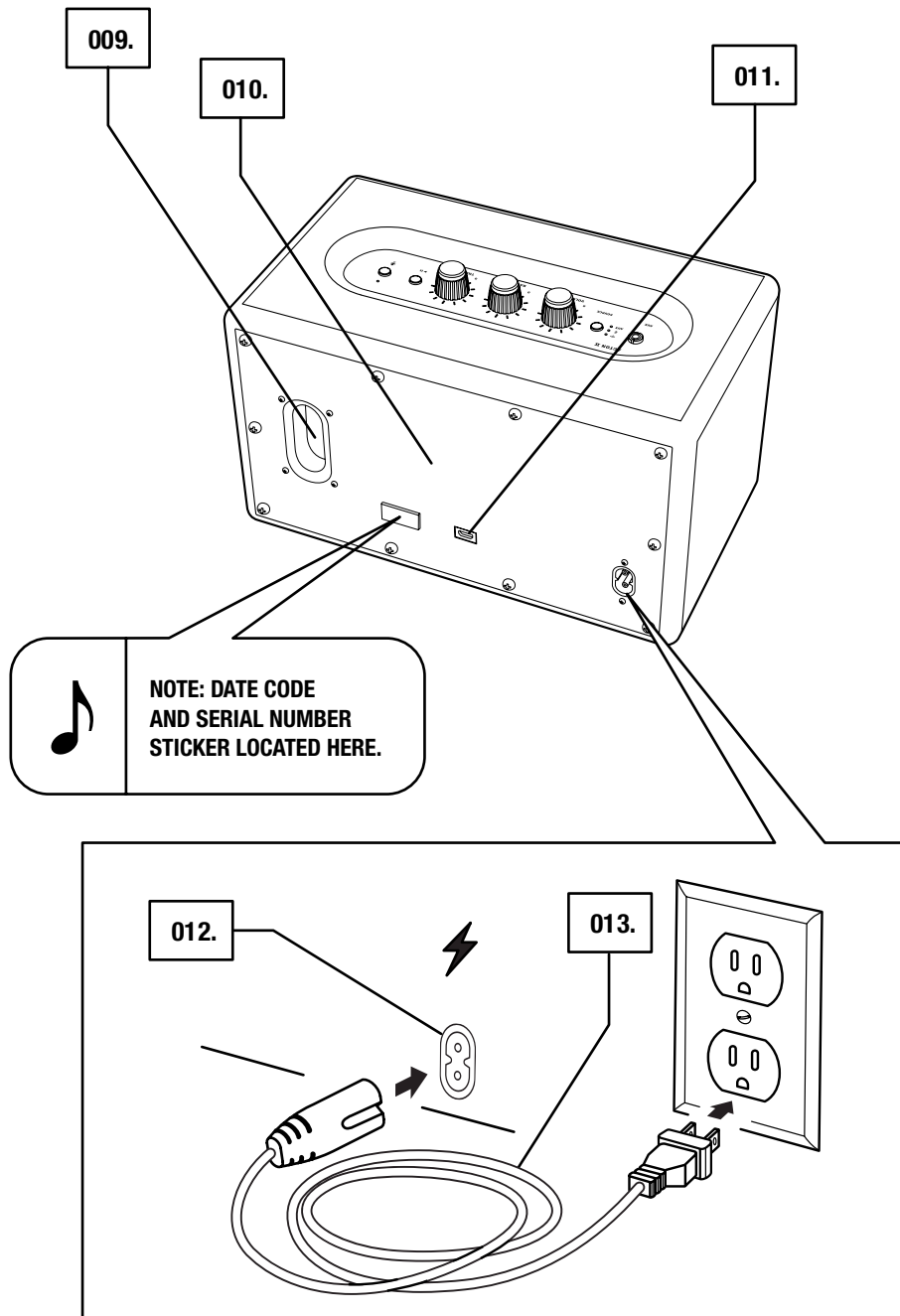

PLUGGING IN THE ACTON II VOICE

IMPORTANT: ALWAYS ENSURE THAT THE MAINS LEAD, MAINS PLUG AND SPEAKER ARE COMPATIBLE WITH YOUR MAINS SUPPLY AND WALL SOCKET.

- 001. CONNECT THE MAINS LEAD INTO THE MAINS INPUT ON THE SPEAKER.**
- 002. CONNECT THE MAINS PLUG TO THE WALL SOCKET.**



CAUTION: ALWAYS UNPLUG THE MAINS LEAD FROM THE WALL SOCKET BEFORE DISCONNECTING IT FROM THE SPEAKER.

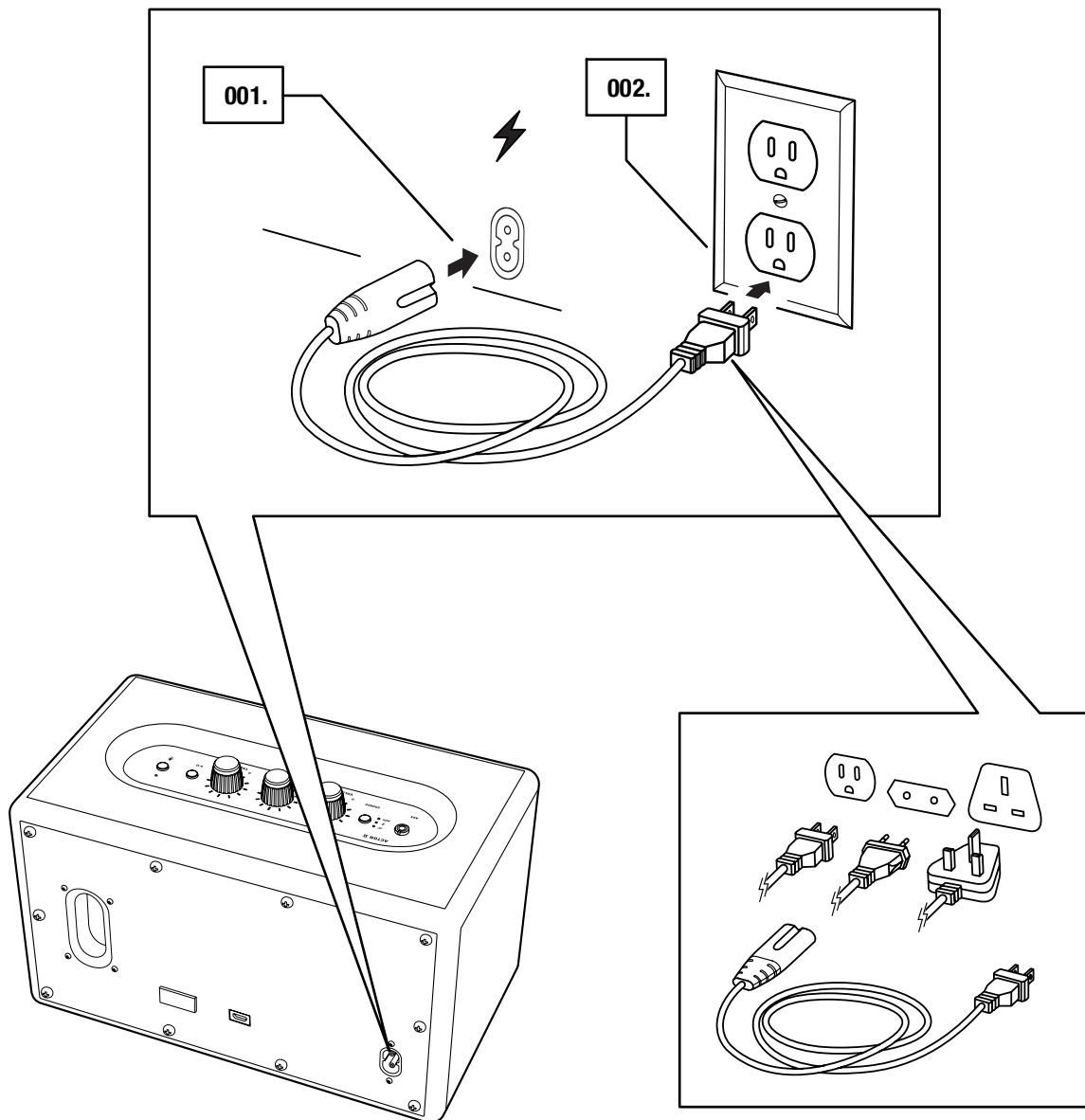

SETTING UP THE ACTON II VOICE

CONFIGURE THE SPEAKER FOR Wi-Fi® WITH THE **GOOGLE HOME** APP. THE APP IS AVAILABLE FROM THE APP STORE AND GOOGLE PLAY.

001. DOWNLOAD THE **GOOGLE HOME** APP AND FOLLOW THE IN-APP INSTRUCTIONS TO SET UP YOUR SPEAKER.



USING THE GOOGLE ASSISTANT BUILT-IN

THE ACTON II VOICE HAS THE GOOGLE ASSISTANT BUILT-IN. YOU CAN PLAY MUSIC, FIND ANSWERS ON GOOGLE SEARCH, MANAGE EVERYDAY TASKS, AND EASILY CONTROL SMART DEVICES AROUND YOUR HOUSE, SIMPLY BY USING YOUR VOICE.

LISTEN TO YOUR FAVOURITE SONG, FIND A DELICIOUS BROWNIE RECIPE, OR CHECK YOUR COMMUTE TO WORK.

JUST START BY SAYING **OK GOOGLE**.

- OK GOOGLE, HOW'S THE WEATHER?
- OK GOOGLE, TURN UP THE VOLUME.
- OK GOOGLE, REWIND 15 SECONDS.

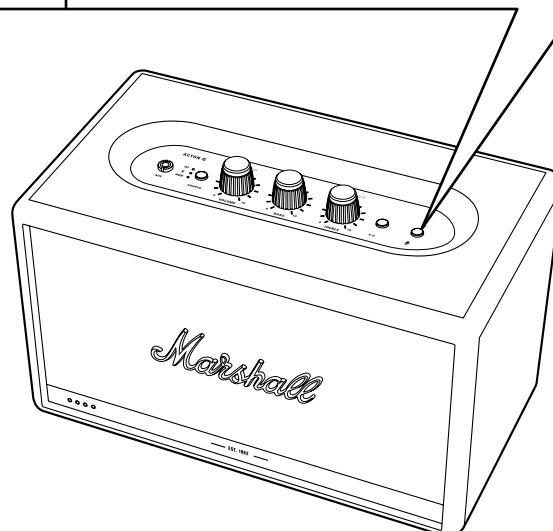
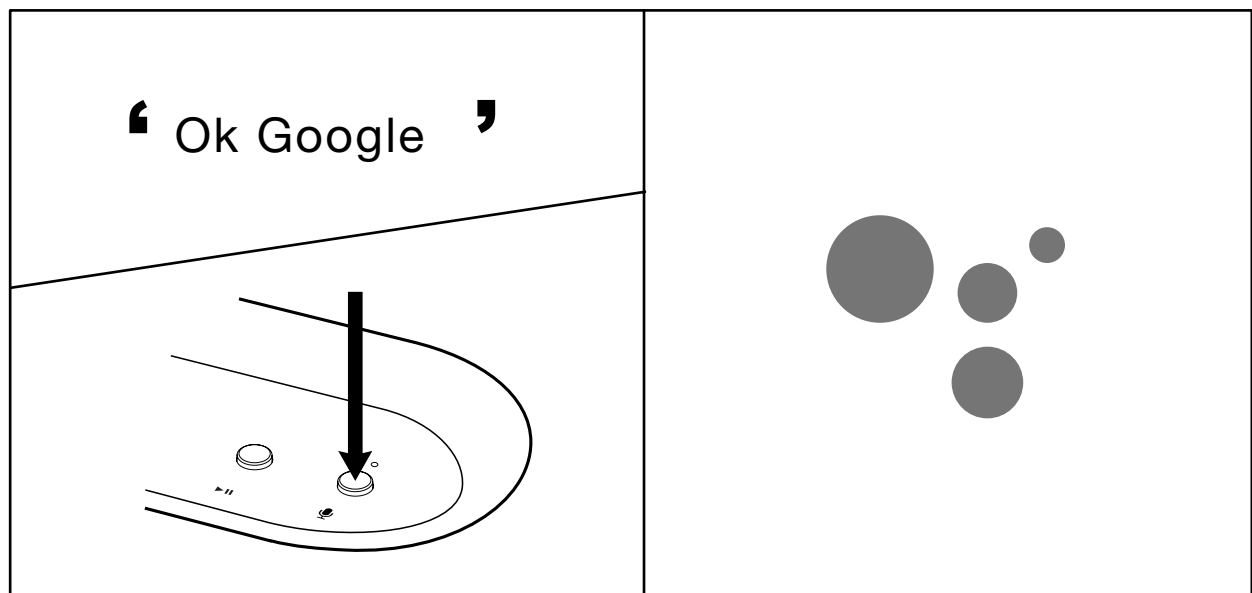

SELECTING AUDIO SOURCE

THERE ARE MANY WAYS TO CONNECT TO YOUR ACTON II VOICE, EITHER WIRELESSLY OR BY CABLE.

-  - Wi-Fi STREAMING VIA CHROMECAST
-  - WIRELESS Bluetooth® CONNECTION
- AUX - 3.5 mm STEREO JACK

001. PUSH THE **SOURCE** BUTTON TO TOGGLE BETWEEN Wi-Fi, Bluetooth AND AUX AUDIO SOURCE.

002. A LIT INDICATOR SHOWS WHICH SOURCE IS SELECTED.

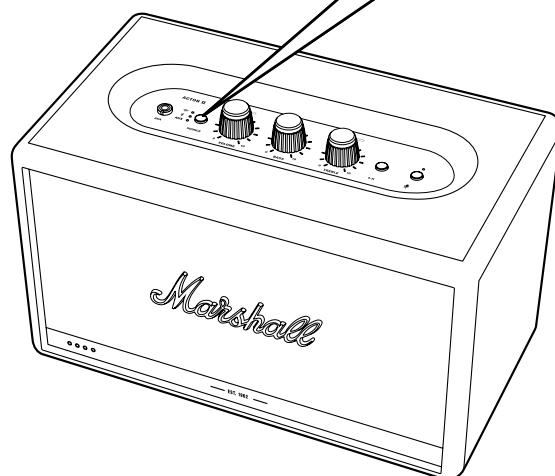
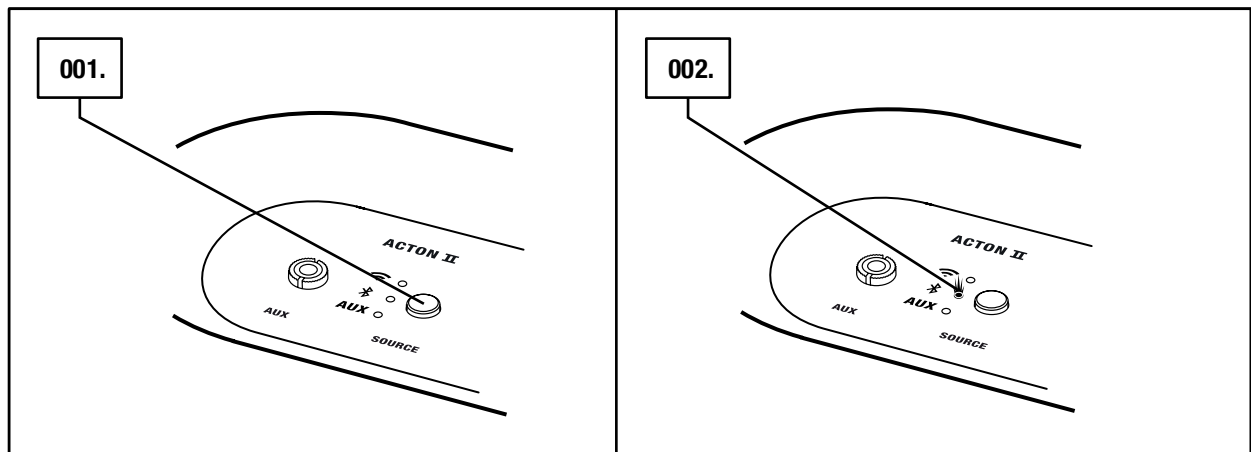

CAUTION: MAKE SURE THAT THE VOLUME IS SET TO LOW ON BOTH THE SPEAKER AND THE MUSIC PLAYER BEFORE USING THE SPEAKER.

USING ACTON II VOICE WITH Chromecast built-in

Chromecast built-in IS A PLATFORM THAT LETS YOU STREAM YOUR FAVOURITE MUSIC FROM YOUR SMARTPHONE, TABLET OR COMPUTER RIGHT TO YOUR SPEAKER. IT IS AVAILABLE IN MOST MUSIC APPS ON THE MARKET.

001. CONNECT YOUR DEVICE TO THE SAME Wi-Fi NETWORK AS YOUR SPEAKER.

002. PLAY MUSIC IN YOUR FAVOURITE MUSIC APP.

003. TAP THE Chromecast built-in ICON IN YOUR MUSIC APP AND SELECT YOUR **ACTON II VOICE.**

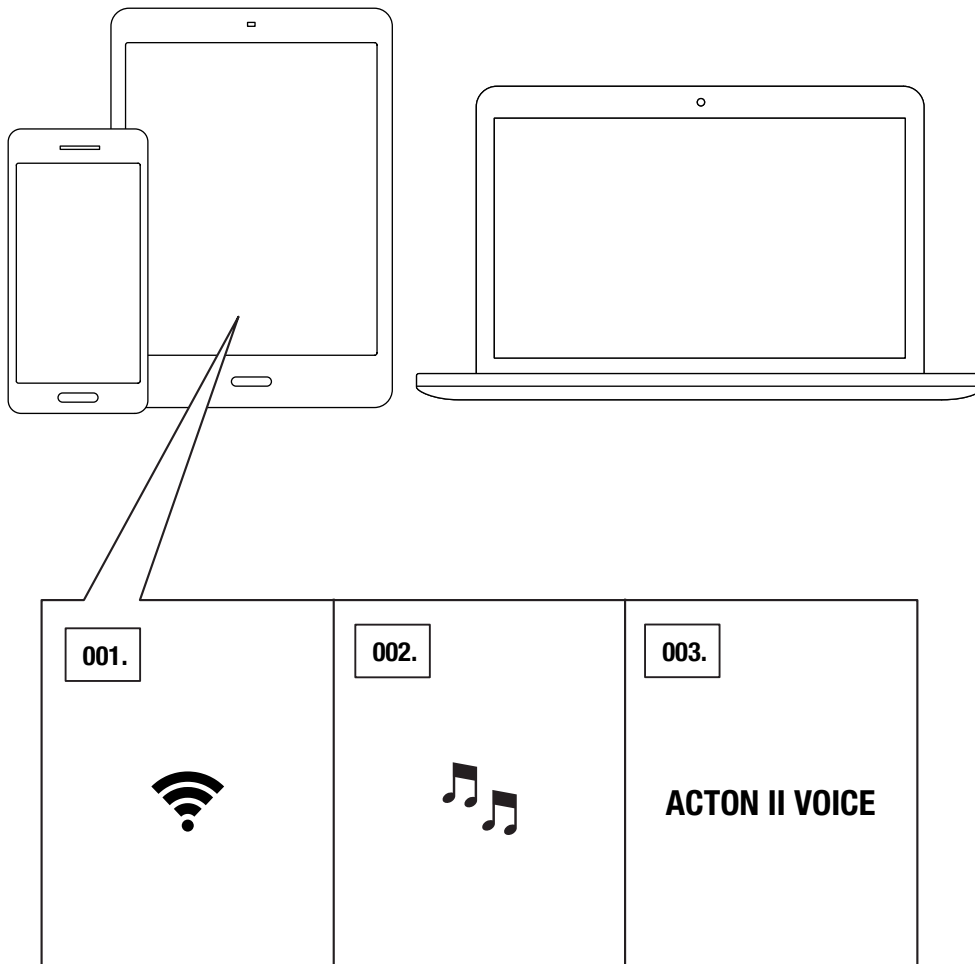

CONNECTING VIA Bluetooth® (PAIRING)

001. SELECT Bluetooth AS THE INPUT. PUSHING THE **SOURCE** BUTTON TOGGLES THE INPUT SOURCES.
002. PUSH AND HOLD THE **SOURCE** BUTTON FOR 2 SECONDS. THE Bluetooth INDICATOR STARTS TO BLINK.
003. ENABLE Bluetooth ON YOUR DEVICE (SMARTPHONE, TABLET, COMPUTER).
004. SELECT **ACTON II VOICE** FROM THE Bluetooth LIST AND ACCEPT PAIRING. THE Bluetooth INDICATOR ON THE SPEAKER STOPS BLINKING AND REMAINS LIT WHEN THE UNITS ARE CONNECTED.

THE ACTON II VOICE STORES UP TO EIGHT Bluetooth DEVICES AND TRIES TO CONNECT TO THE LAST CONNECTED DEVICE FIRST. FOR EXAMPLE, IF THE SPEAKER HAS BEEN CONNECTED TO THE DEVICES: **A-B-C-D-E-F-G-H** DEVICE **H** IS GIVEN FIRST PRIORITY, WHILE DEVICE **A** IS GIVEN LAST PRIORITY. EVERY TIME IS SELECTED, THE SPEAKER WILL PERFORM AN AUTO CONNECTION OF DEVICES WITHIN ITS RANGE.

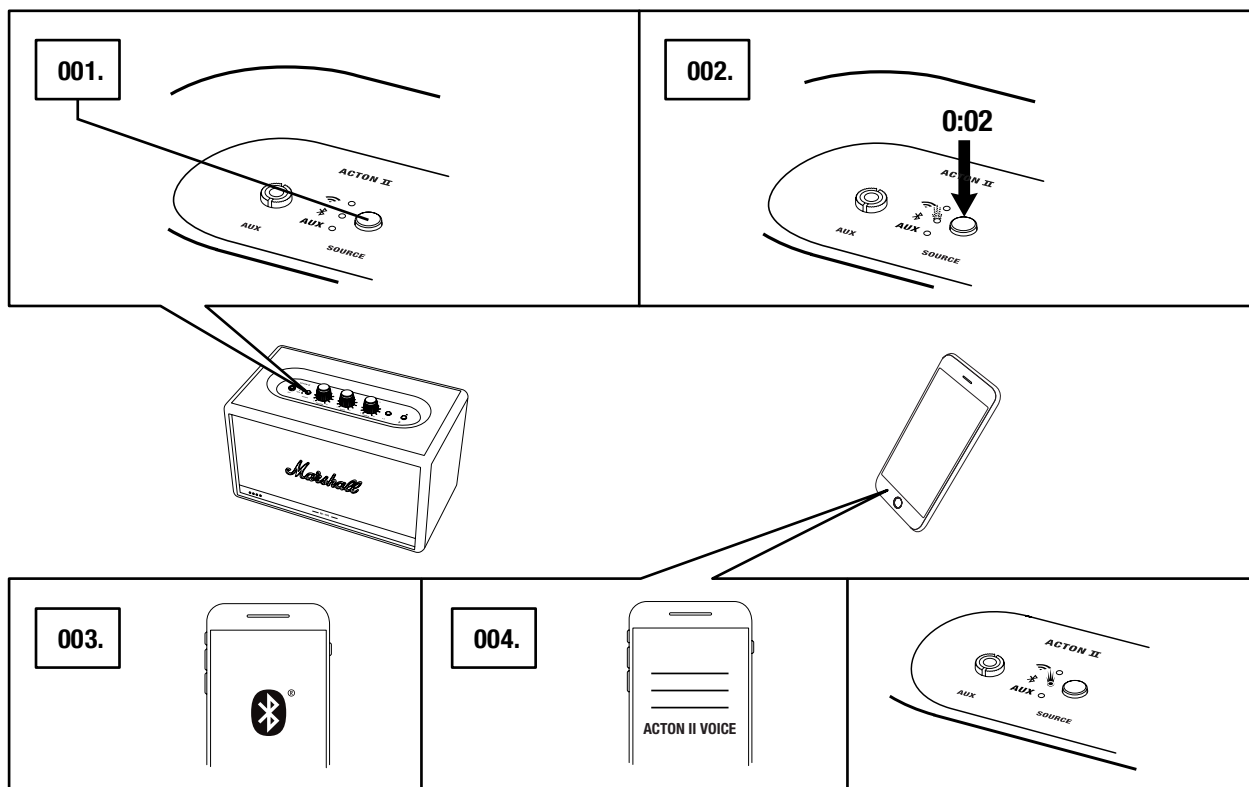

CONNECTING VIA AUX INPUT

001. CONNECT A 3.5 mm STEREO JACK TO THE INPUT LABELLED **AUX** ON THE TOP OF SPEAKER.
002. CONNECT THE OTHER END OF THE LEAD TO THE AUDIO OUTPUT ON YOUR AUDIO SOURCE.
003. SELECT AUX AS THE INPUT. PUSHING THE **SOURCE** BUTTON TOGGLES THE INPUT SOURCES.

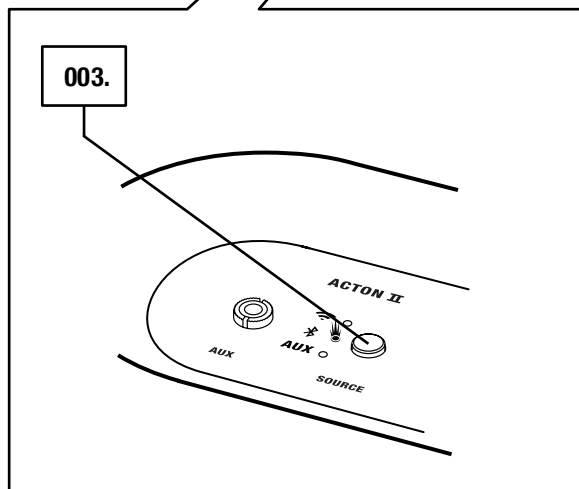
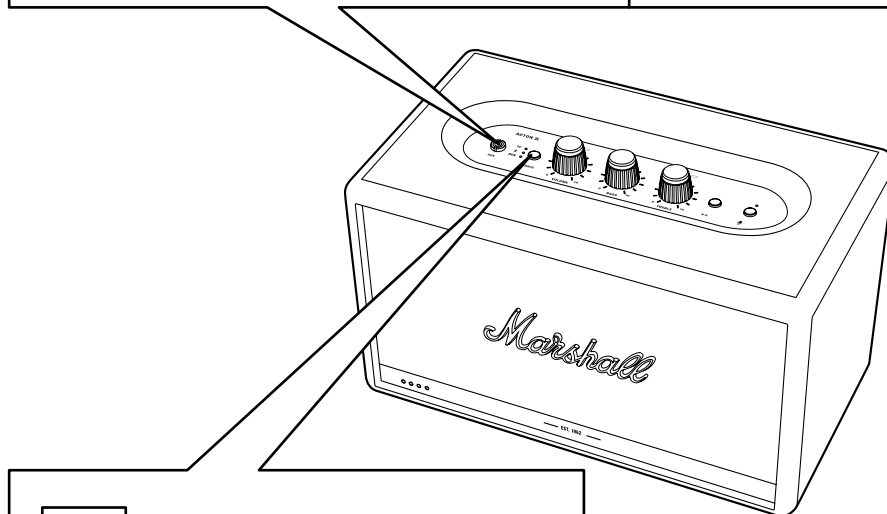
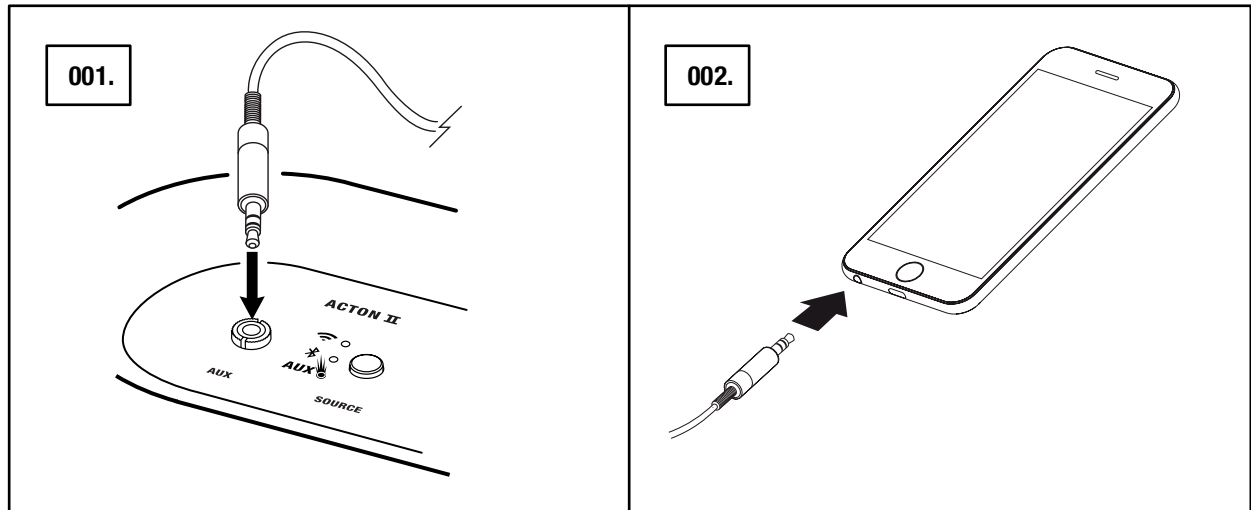

 NOTE: AUDIO LEADS ARE NOT INCLUDED IN THE ACTON II VOICE.

ADJUSTING THE VOLUME/BASS/TREBLE

THE ACTON II VOICE INCLUDES THREE KNOBS FOR ADJUSTING THE AUDIO.

001. VOLUME KNOB

002. BASS KNOB

003. TREBLE KNOB

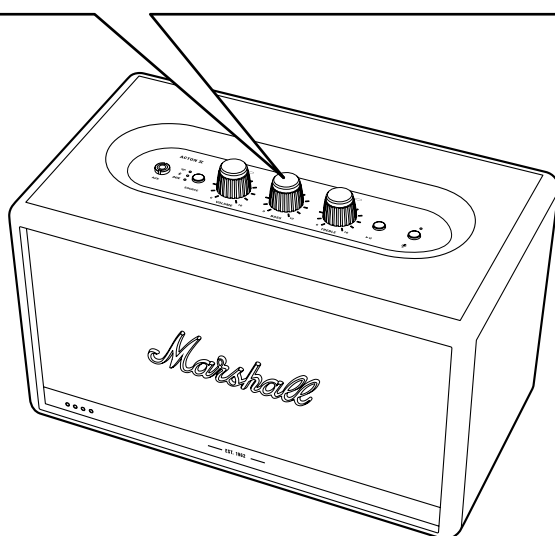
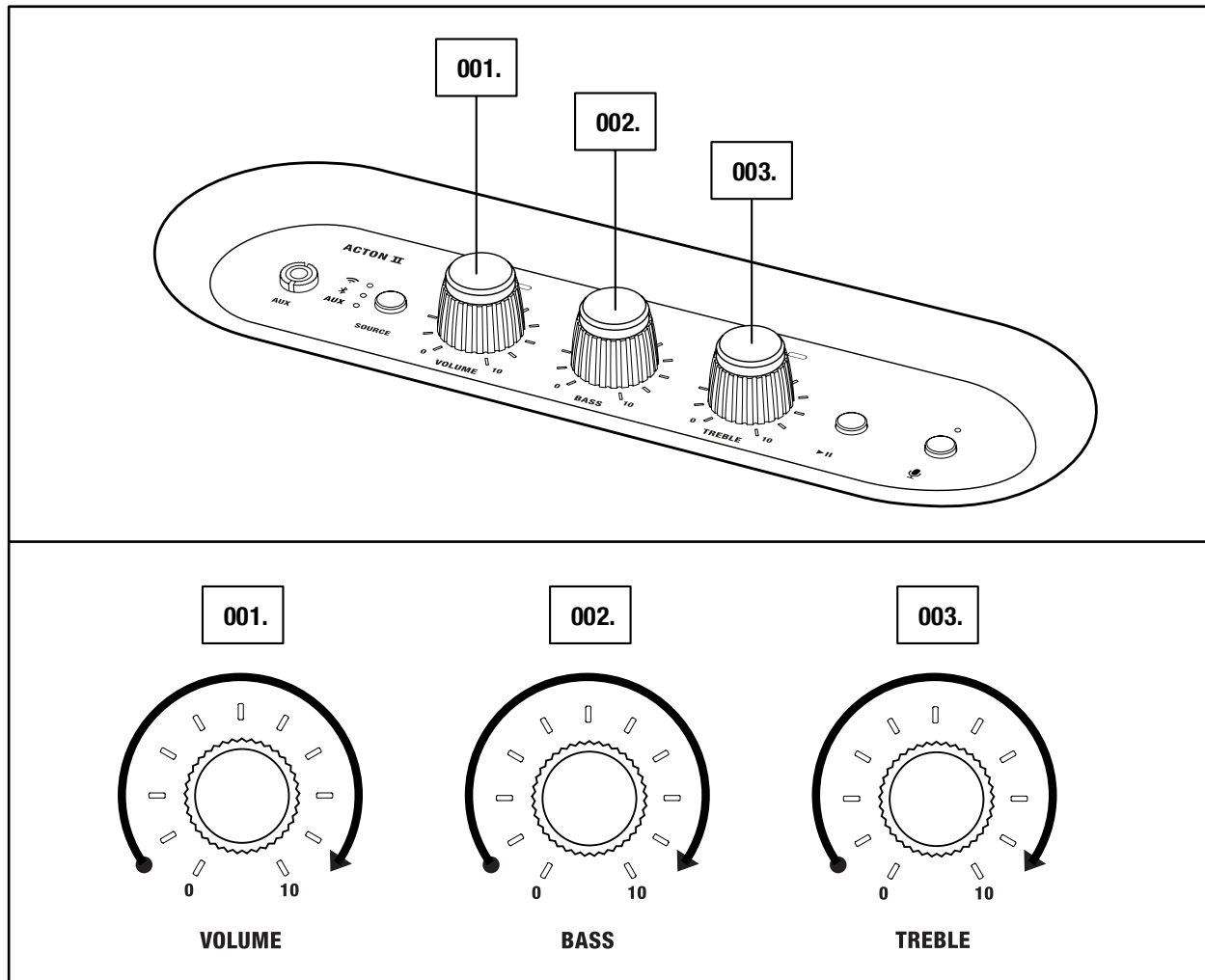

PLAY/PAUSE CONTROL

THE ACTON II VOICE HAS A PLAY/PAUSE BUTTON TO CONTROL THE MUSIC WHEN PLAYING VIA Wi-Fi OR Bluetooth.

001. SINGLE-CLICK TO EITHER PLAY OR PAUSE.

002. DOUBLE-CLICK TO SKIP FORWARD.

003. TRIPLE-CLICK TO SKIP BACK.

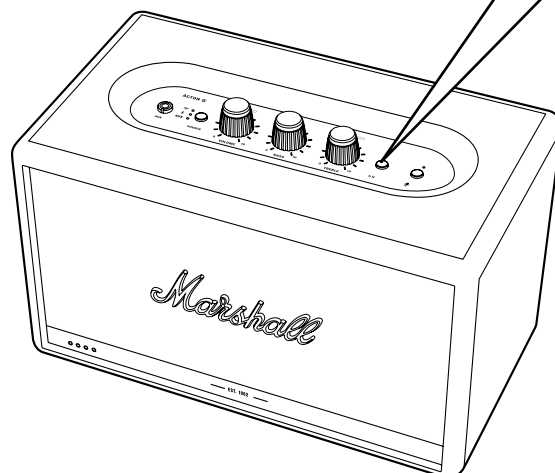
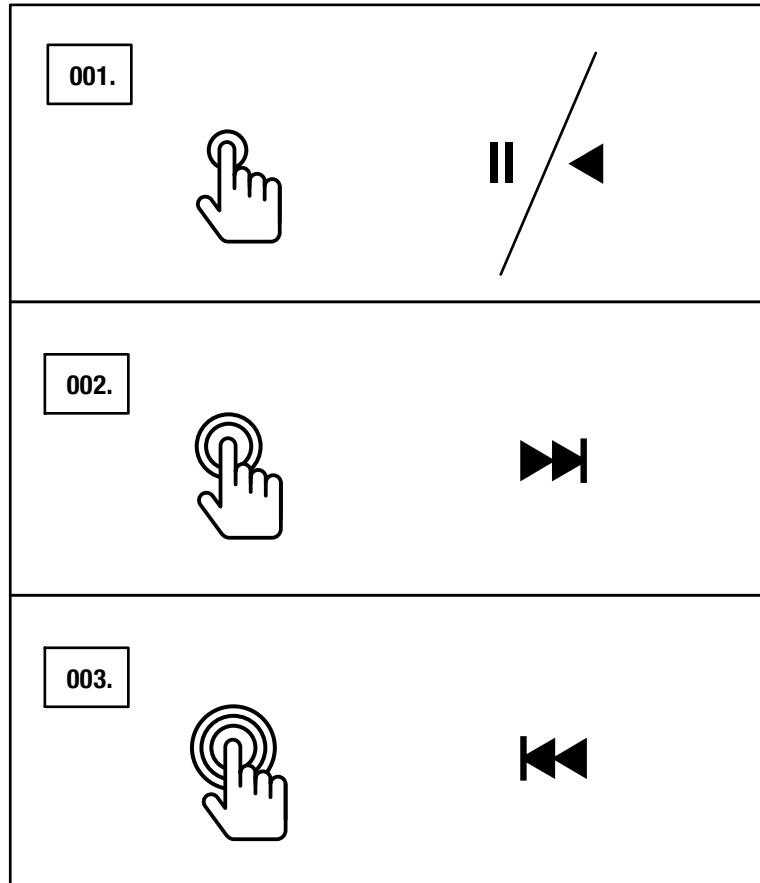

MUTING/UNMUTING THE MICROPHONE

THE MICROPHONES IN THE ACTON II VOICE CAN BE TEMPORARILY TURNED OFF.

001. PUSH THE MICROPHONE BUTTON MUTE THE MICROPHONES.

THE LED INDICATORS ON THE FRONT TURNS ORANGE TO INDICATE THAT THE MICROPHONE IS MUTED.

002. TO UNMUTE, PUSH THE MICROPHONE BUTTON AGAIN.

THE LED INDICATORS ON THE FRONT TURNS OFF TO INDICATE THAT THE MICROPHONE IS UNMUTED.

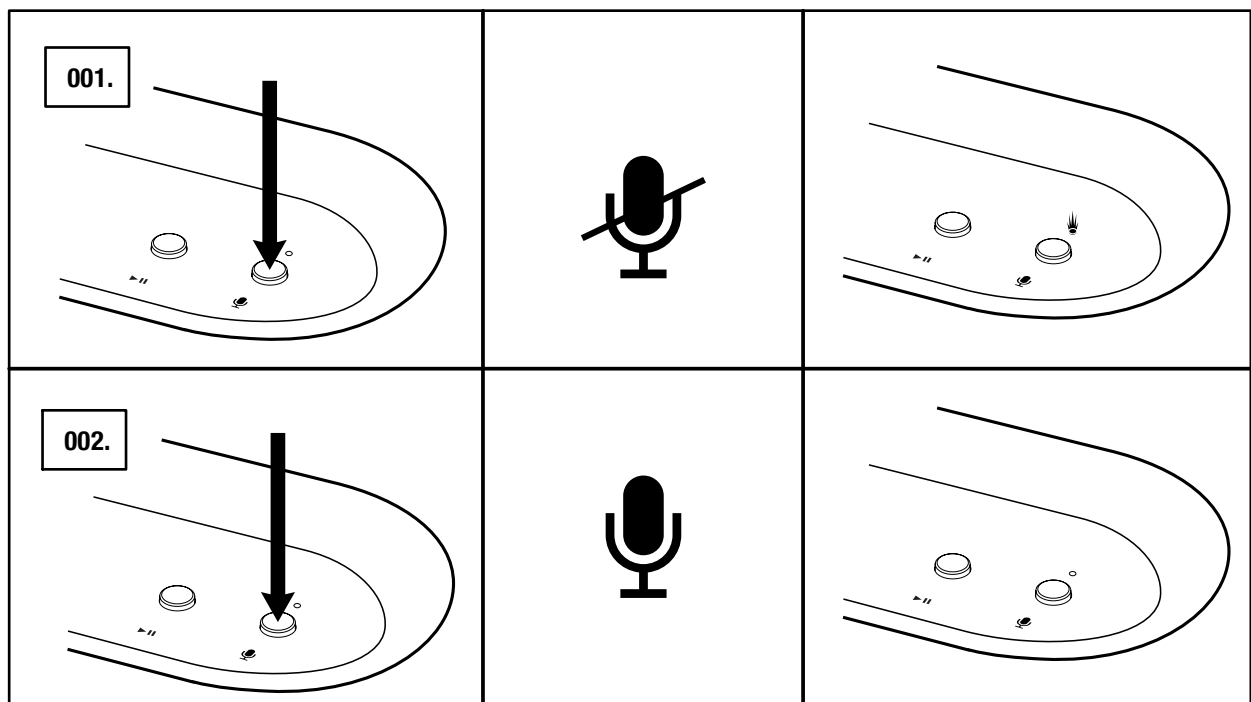

NOTE: GOOGLE ASSISTANT CAN NOT BE ACTIVATED WHILE THE MICROPHONES ARE MUTED.

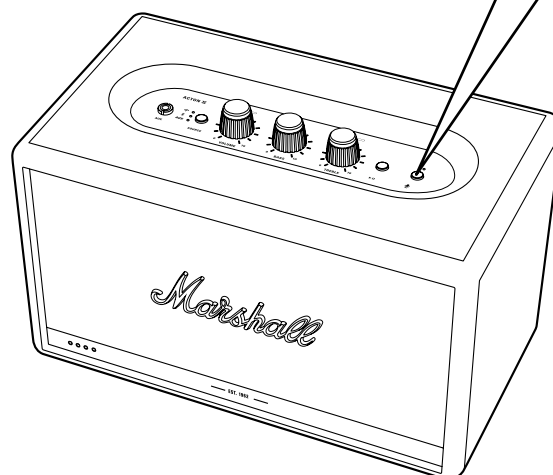

TECHNICAL INFORMATION

ACOUSTIC SPECIFICATION

- **STEREO LOUDSPEAKER WITH BASS REFLEX SYSTEM**
- **DIGITAL CLASS D AMPLIFIERS:** 2 x 15 W + 1 x 30 W
- **TWEETERS:** 2 x ¾" dome tweeters
- **WOOFER:** 1 x 4" woofer
- **BASS AND TREBLE TONE CONTROLS**
- **FREQUENCY RESPONSE:** 50–20,000 Hz ±6 dB
- **MAXIMUM SOUND PRESSURE LEVEL:** 98 dB SPL @ 1 m

TECHNICAL INFORMATION

- **MAINS INPUT VOLTAGE:** 100–240 VAC
- **MAINS FREQUENCY:** 50–60 Hz
- **WIRELESS CONNECTIVITY:**
 - Chromecast built-in
 - Bluetooth
- **WIRED CONNECTIVITY:**
 - AUX: 3.5 mm stereo jack
- **Wi-Fi SUPPORT:** Connects to your home Wi-Fi network with any WPA, 802.11b/g/n/ac 2.4 GHz/5 GHz with diversity.
- **SIZE:** 260 x 160 x 150 mm
- **WEIGHT:** 2.85 Kg
- **VOICE CONTROL SERVICE:** Google Assistant
- **MICROPHONE SYSTEM:** Two omnidirectional microphones on the top panel for voice interaction.

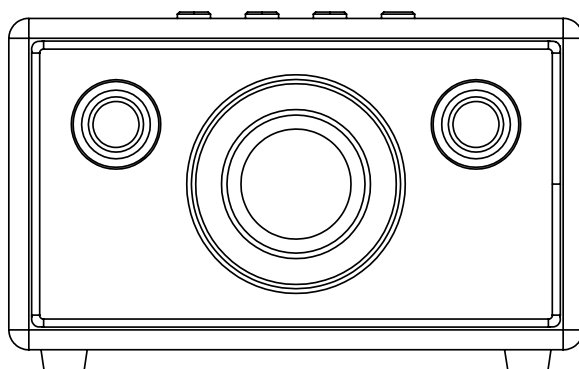

NOTE: THE FRONT OF THE SPEAKER IS NOT REMOVABLE. THIS ILLUSTRATION INTENDS TO SHOW THE INTERNAL SPEAKER LAYOUT. DO NOT ATTEMPT TO REMOVE THE FRET FOR RISK OF DAMAGING YOUR SPEAKER.

TROUBLESHOOTING

PROBLEM	CAUSE	ACTION
THE ACTON II DOES NOT TURN ON	The speaker is not connected to mains electricity supply.	Connect the mains lead to the Acton II and a working wall socket. Pull and hold the power lever towards the front of the speaker until the indicators light up.
THE ACTON II VOICE CANNOT BE DISCOVERED BY THE GOOGLE HOME APP	The speaker is not in setup mode.	Select Wi-Fi as the input. Push and hold the Source button for 3 seconds to set the speaker in discoverable mode.
	The speaker and the mobile device are not connected to the same Wi-Fi network.	Ensure that your mobile device is connected to the same Wi-Fi network that the speaker was configured on.
THE GOOGLE ASSISTANT IS NOT RESPONDING	The microphone is muted on the speaker.	Push and hold the microphone button for 3 seconds. The LED indicators on the front turns off to indicate that the microphone is unmuted.
THERE IS NO AUDIO OR AUDIO IS TOO LOW	The wrong audio source is selected.	Ensure that the device is connected to the Acton II. Check that no other device is connected and playing.
	Volume is set too low on either the audio source or the speaker.	Slightly increase the volume on your audio source or the speaker.

TROUBLESHOOTING

PROBLEM	CAUSE	ACTION
CANNOT CONNECT OR PAIR WITH A Bluetooth DEVICE	Bluetooth is not enabled on your device (smartphone, tablet, computer).	Activate Bluetooth on your device.
	There are already two devices connected to the speaker.	Disconnect one of the connected Bluetooth devices before connecting to the speaker.
	The speaker is not in pairing mode.	Push and hold the Bluetooth button for 3 seconds to make the speaker discoverable by the device.
THE SPEAKER IS NOT RESPONDING	A software problem has occurred.	Unplug the mains power plug from the wall socket, wait for 15 seconds, then plug it in again.
		Perform a factory reset. Note: This will delete all user settings and after the factory reset, the speaker needs to be set up again. Push and hold both the Source button and the Play/pause button for 7 seconds.
BLUETOOTH CONNECTION DROPS OUT	The two Bluetooth devices are too far apart or the connection is affected due to obstacles.	Move the devices closer so that they are within 10 metres, and unobstructed by obstacles such as walls or doors.
	There is a strong electric field surrounding the Acton II.	Items such as microwave ovens, wireless network adapters, fluorescent lights and gas cookers use the same frequency range as the Bluetooth device. This may lead to electrical disturbances.

TROUBLESHOOTING

PROBLEM	CAUSE	ACTION
THERE IS A CRACKLING SOUND	The amplifier is clipping as it has run out of output power.	Decrease the volume on your audio source.
		Lower the volume or bass on the Acton II.
THE AUDIO IS DISTORTED	Volume is set too high on the audio source.	Turn down the playback volume on the audio source.
	The audio stream or audio file is of poor quality.	Try another audio file or music player.
	Volume is set too high on the Acton II.	Lower the volume on the speaker.
	Too much bass/treble on the speaker.	Lower the bass/treble on the speaker.
ERRATIC PERFORMANCE	Interference from another electronic device.	Move the Acton II to another spot.
		Turn off or move the interfering electronic device.



NOTES:

A Wi-Fi DEVICE COULD CAUSE AUDIO-RELATED OR TECHNICAL FAULTS, DEPENDING ON USE, IN THE FOLLOWING CASES:

- **WHEN SOME PART OF THE BODY IS IN CONTACT WITH THE RECEIVING/TRANSMITTING SYSTEM FOR THE Wi-Fi DEVICE OR THE ACTON II.**
- **ELECTRICAL VARIATIONS DUE TO OBSTACLES IN THE FORM OF WALLS, CORNERS, ETC.**
- **EXPOSURE TO ELECTRICAL DISRUPTIONS FROM DEVICES WITHIN THE SAME FREQUENCY BAND, FOR EXAMPLE MEDICAL EQUIPMENT, MICROWAVE OVENS OR OTHER WIRELESS NETWORKS.**

THIS WIRELESS DEVICE MAY CAUSE ELECTRICAL DISRUPTIONS DURING USE.

WWW.MARSHALLHEADPHONES.COM