

User manual
Washing machine

HW80-B14876

HW100-B14876

GB

Haier

Thank you for purchasing a Haier Product.

Please read these instructions carefully before using this appliance. The instructions contain important information which will help you get the best out of the appliance and ensure safe and proper installation, use and maintenance.

Keep this manual in a convenient place so you can always refer to it for the safe and proper use of the appliance.

If you sell the appliance, give it away, or leave it behind when you move house, make sure you also pass this manual so that the new owner can become familiar with the appliance and safety warnings.

Legend



Warning – Important Safety information



General information and tips



Environmental information

Disposal



Help protect the environment and human health. Put the packaging in applicable containers to recycle it. Help to recycle waste of electrical and electronic appliances. Do not dispose appliances marked with this symbol with the household waste. Return the product to your local recycling facility or contact your municipal office.



WARNING!

Risk of injury or suffocation!

Disconnect the appliance from the mains supply. Cut off the mains cable and dispose of it. Remove the door catch to prevent children and pets to get closed in the appliance.

1-Safety information.....	4
2-Productdescription.....	7
3-Control panel.....	8
4-Programmes.....	12
5-Consumption.....	13
6-Daily use.....	14
7-Eco-friendly washing.....	19
8-Care and cleaning.....	20
9-Troubleshooting.....	23
10-Installation.....	27
11-Technical data.....	31
12-Customer service.....	33

Before switching on the appliance for the first time read the following safety hints!:



WARNING!

Before first use

- ▶ Make sure there is no transport damage.
- ▶ Make sure all transport bolts are removed.
- ▶ Remove all packaging and keep out of children's reach.
- ▶ Handle the appliance always with at least two persons because it is heavy.

Daily use

- ▶ This appliance can be used by children aged from 8 years and above and persons with reduced physical, sensory or mental capabilities or lack of experience and knowledge if they have been given supervision or instruction concerning use of the appliance in a safe way and understand the hazards involved.
- ▶ Keep away children under 3 years of age from the appliance unless they are constantly supervised.
- ▶ Children shall not play with the appliance.
- ▶ Do not let children or pets come close to the appliance when the door is open.
- ▶ Store washing agents out of reach of children.
- ▶ Pull up zips, fix loose threads and take care for small items to prevent laundry from being entangled. If necessary, use an appropriate bag or net.
- ▶ Do not touch or use the appliance when barefoot or with wet or damp hands or feet.
- ▶ Do not cover or encase the appliance during operation or afterwards to allow any moisture or dampness to evaporate.
- ▶ Do not place heavy objects or sources of heat or damp on top of the appliance.
- ▶ Do not use or store flammable detergent or dry cleaning agent in close vicinity to the appliance.
- ▶ Do not use any flammable sprays in close vicinity to the appliance.
- ▶ Do not wash any garments treated with solvents in the appliance without having dried them previously in the air.



WARNING!

Daily use

- ▶ Do not remove or insert the plug in the presence of flammable gas
- ▶ Do not hot wash foam rubber or sponge-like materials.
- ▶ Do not wash any laundry which is polluted with flour.
- ▶ Do not open detergent drawer during any wash cycle.
- ▶ Do not touch the door during the washing process, it gets hot.
- ▶ Do not open the door if the water level is visibly over the porthole.
- ▶ Do not force the door to open. The door is fitted with a self-lock device and will open shortly after the washing procedure is ended.
- ▶ Switch off the appliance after each wash programme and before undertaking any routine maintenance and disconnect the appliance from the electrical supply to save electricity and for safety.
- ▶ Hold the plug, not the cable, when unplugging the appliance.

Maintenance / cleaning

- ▶ Make sure children are supervised if they carry out cleaning and maintenance.
- ▶ Disconnect the appliance from the electrical supply before undertaking any routine maintenance.
- ▶ Keep the lower part of the porthole clean and open door and detergent drawer if appliance is not in use to prevent odours.
- ▶ Do not use water spray or steam to clean the appliance.
- ▶ Replace a damaged supply cord only by the manufacturer, its service agent or similarly qualified persons in order to avoid a hazard.
- ▶ Do not try to repair the appliance by yourself. In case of repair please contact our customer service.

Installation

- ▶ The appliance should be placed in a well-ventilated place. Ensure a location which allows opening the door fully.
- ▶ Never install the appliance outdoors in a damp place, or in an area which may be prone to water leaks such as under or near a sink unit. In the event of a water leak cut power supply and allow the machine to dry naturally.



WARNING!

Installation

- ▶ Install or use the appliance only where the temperature is above 5 °C.
- ▶ Do not place the appliance directly on a carpet, or close to a wall or furniture.
- ▶ Do not install the appliance in direct sunlight or in the near of heat sources(e.g. stoves, heaters).
- ▶ Make sure that the electrical information on the rating plate agrees with the power supply. If it does not, contact an electrician.
- ▶ Do not use multi-plug adapters and extension cables.
- ▶ Make sure only the delivered electric cable and hose set are used.
- ▶ Make sure not to damage the electric cable and the plug. If damaged have it replaced by an electrician.
- ▶ Use a separate earthed socket for the power supply which is easy accessible after installation. The appliance must be earthed.
Only for UK: The appliance's power cable is fitted with 3-cord (grounding) plug that fits a standard 3-cord (grounded) socket. Never cut off or dismount the third pin (grounding). After the appliance is installed, the plug should be accessible.
- ▶ Make sure the hose joints and connections are firm and there is no leakage.

Intended use

This appliance is intended for washing machine-washable laundry only. Anytime follow the instructions given on the label of each garment label. It is designed exclusively for domestic use inside the house. It is not intended for commercial or industrial use.

Changes or modifications to the device are not allowed. Unintended use may cause hazards and loss of of all warranty and liability claims.

i Note:

Due to technical changes and different models, the illustrations in the following chapters may differ from your model.

2.1 Picture of appliance

Front (Fig. 2-1):

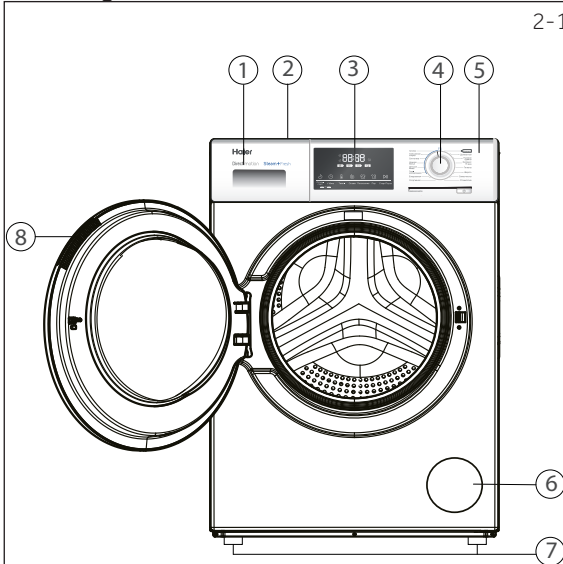

- | | |
|-------------------------------|-------------------|
| 1 Detergent / Softener drawer | 5 Panel |
| 2 Work top | 6 Service flap |
| 3 Display | 7 Adjustable feet |
| 4 Programme selector | 8 Door handle |

Rear side (Fig. 2-2):

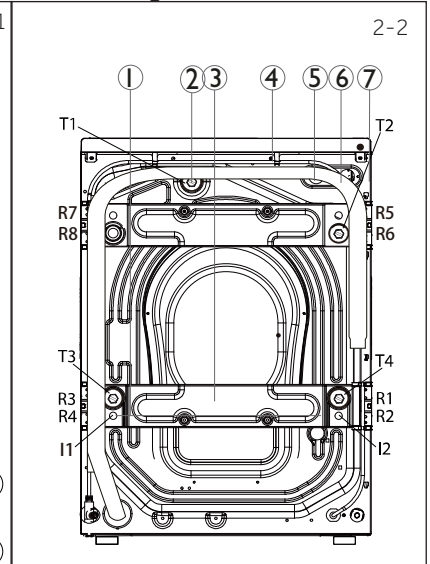

- | |
|--|
| 1 Iron bar (I1-I2) |
| 2 Transportation bolts (T1 -T4) |
| 3 Rear wall reinforcement
(HW80:1 pcs;HW100:2 pcs) |
| 4 Power cord |
| 5 Water inlet valve |
| 6 Drain hose |
| 7 Rear wall reinforcement screws
(HW80:4 pcs ,R1-R4;HW100:8 pcs,R1-R8) |

2.2 Accessories

Check the accessories and literature in accordance with this list (Fig.:2-3):

Inlet hose assembly	6 Blanking plugs	Drain hose bracket	Warranty-card	User manual

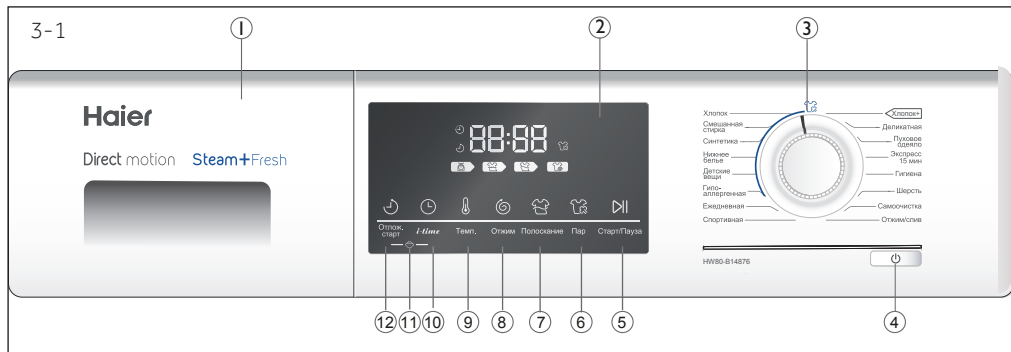

- Function buttons:**
- | | | |
|-------------------------------|------------------|---------------|
| 1 Detergent / Softener drawer | 6 Steam | 11 Child lock |
| 2 Display | 7 Extra Rinse | 12 Delay |
| 3 Programme selector | 8 Speed | |
| 4 "On/Off" button | 9 Temp. | |
| 5 "Start/Pause" button | 10 <i>i-time</i> | |

Note : Acoustic signal

In following cases an acoustic signal sounds:

- ▶ when pressing a button
- ▶ when turning the programme selector
- ▶ at the end of programme
- ▶ in case of failures

The acoustic signal can be deselected if necessary ; see DAILY USE.

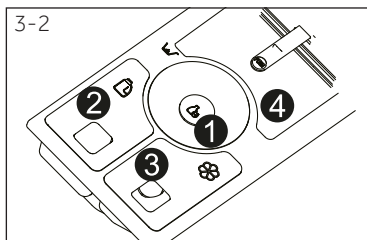

3.1 Detergent drawer

Open the drawer, three compartments can be seen (Fig. 3-2):

- 1** **Compartment**: Bleaching agent for cotton/synthetic programme.
- 2** **Compartment**: Liquid detergent for programme
- 3** **Compartment**: Softener, Conditioning agent etc.
- 4** **Compartment**: Powder detergent for programme









The recommendation on the type of detergents is suitable for the various washing temperatures, please refer to the manual of detergent.

3.2 Display

If the appliance is on display will light up the actual status on different sections. The information include washing time, spin speed, temperature, etc will appear (Fig. 3-3).



Display symbols:

Programme status indication		Programme cycle indication	
 Remaining operation time		 Steam	
 Remaining delay time			
 Automatic weighing	 Wash cycle	 Rinse cycle	 Spin/drainage cycle
 Control panel is locked			

3.3 Programme selector

By turning the knob (Fig. 3-4) one of 16 programmes can be selected, related LED will light up, its default settings will be displayed.

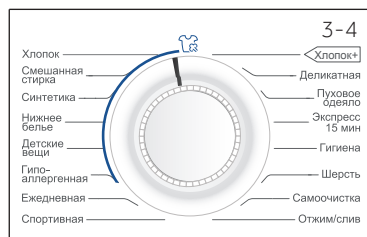

3.4 "On/Off" button

Press this button (Fig. 3-5) gently to switch on, the display is shining, the LEDs in the button are shining. Press it again for about 2 seconds to switch off. If no panel element or programme is activated after a while machine will shut down automatically.



3.5 „Start/Pause“ button

Press this button (Fig. 3-6) gently to start or interrupt the currently displayed programme. During programme run the colon in the displayed washing time is blinking. During a pause also the time display is blinking.

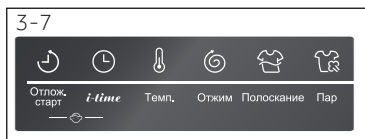

3.6 Function buttons

The function buttons (Fig. 3-7) enables additional options in the selected programme before programme start. The related indicators are displayed.

By switching off the appliance or setting a new programme, all options are disabled.

If a button has multiple options, the desired option can be selected by pressing the button sequentially.

To delete the setting or to cancel the setting process, press the function button until the desired LED lights or -in case of only one option- the LED switches off.

Not all functions are available for all programmes (see PROGRAMMES).

i Note: Factory settings

To get best results in each programme Haier has well defined specific default settings. If there is no special requirement default settings are recommended.



3.6.1 Function "Extra Rinse"

Press this button (Fig. 3-8) to rinse the laundry more intense with fresh water. This is recommended for people with sensitive skin.

By pressing the button several times one to three additional cycles can be selected.

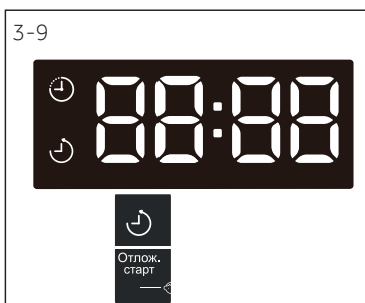

3.6.2 Function "Delay"

Press this button (Fig. 3-9) to start the programme with a delay. End time delay could be increased in steps of 30 minutes from 0,5-24h. For example display off **6:30** means end of programme cycle will be in 6 hours and 30 minutes. Press "Start/Pause" button to activate the time delay.

The time delay must be longer than the programme run time. Otherwise the programme will start immediately.

For deactivating the time delay; rotate programme selector.

i Note: Liquid detergent

If using liquid detergent, it is not recommended to activate the end time delay.

3.6.3 Function "i-time"

Touch the *i-time* button can choose different washing time. This function does not apply to "self clean" and "spin/Drain" programs. (Fig. 3-10)

3.6.4 Function "Steam"

Press this button (Fig. 3-11) the steam program can be selected. When this program is selected the default temperature is the max temperature of this program. You can select if you require this function when programs "Cotton, Mix, Synthetic, Under-wear, Baby Care, Anti-allergy" are used. When you select the program "steam" the icon light up to warn you, the icon turns off when the program is canceled.

When you select the program, you cannot change the temperature. If you press the temperature button the program will be canceled.

Switch on the washing machine and select this program

If the washing machine is working you can not select this program.

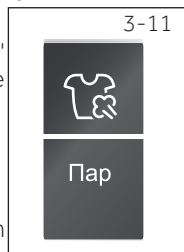
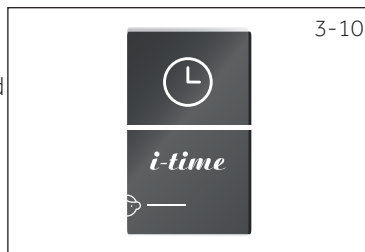

3.6.5 Function "Speed"

Press this button (Fig. 3-12) to change or deselect the spin of the programme. If no value is illuminated the laundry will not spin.

In conjunction with the "Temp" button, the child lock function can be switch on/off (see CHILD LOCK).

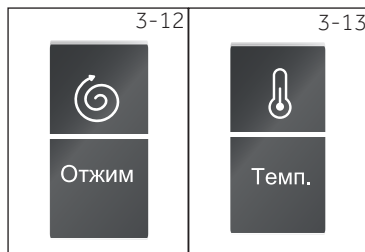

3.6.6 Function "Temp."

Press this button (Fig. 3-13) to change the washing temperature of the programme.

In conjunction with the "Spin speed" button, the child lock function can be switch on/off (see CHILD LOCK).

3.6.7 Function "Child lock"

This option blocks all panel elements against activation. After programme start press button "Steam" and "Delay" (Fig. 3-14 for 3 seconds simultaneously; child lock symbol is displayed. For unlocking press again the two buttons.



4-Programmes

GB

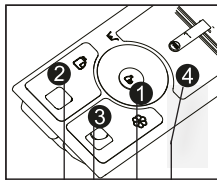

Detergent compartment for:

- ① Bleaching agent
- ② Liquid detergent
- ③ Softener, Conditioning agent etc.
- ④ Powder detergent

● Yes, ○ Optional, / No

Programme	Max. load in kg HW100/ HW80	Temperature ¹⁾ in °C		Detergent compartment				Fibre type	Preset Spin speed in rpm	Function			
		max	Preset	1	2	3	4			Delay	Steam	Extra Rinse	i-time
Cotton	10/8	90 ²⁾	30	●	○	/	●	Cotton	1000	●	●	●	●
Mix	10/8	60	30	●	○	/	●	Lightly soiled mixed-laundry of cotton and synthetic	1000	●	●	●	●
Synthetic	10/8	60	30	●	○	/	●	Synthetic or mixed fabric	1000	●	●	●	●
Under-wear	5/4	60	40	●	○	/	●	Cotton/Synth	1000	/	/	●	●
Baby Care	5/4	90 ²⁾	40	●	○	/	●	Cotton/Synth	1000	/	●	●	●
Anti-allergy	5/4	90 ²⁾	60	●	○	/	●	Cotton/Synth	1000	/	●	●	●
Daily Wash	5/4	60	30	●	○	/	●	Cotton	1000	●	/	●	●
Sport	2.5/2	40	20	●	○	/	●	Sports Wear	800	/	/	●	●
Cotton+	10/8	90 ²⁾	30	●	○	/	●	Cotton; standard programme for Energy Labelling	1000	●	/	●	●
Delicate	2.5/2	30	30	●	○	/	●	Silk	600	/	/	●	●
Duvet	2.5/2	40	30	●	○	/	●	Cotton fabrics	800	/	/	●	●
Express 15 min ³⁾	2.5/2	40	*	●	○	/	●	Cotton/Synthetic	1000	/	/	●	●
Hygienic	5/4	90 ²⁾	90 ²⁾	●	○	/	●	Cotton/Synth	1000	/	●	●	●
Wool	1/1	40	*	●	○	/	●	Wollen fabrics	800	/	/	●	●
Self Clean	0	90 ²⁾	90 ²⁾	○	/	/	/	---	600	/	/	/	●
Spin/ drain	10/8	/	/	/	/	/	/	all fabrics	1000	/	/	/	●

¹⁾ Relating to dry laundry. *: Water is not heated up.

²⁾ Choose 90 °C wash temperature only for special hygienic requirements.

³⁾ Reduce detergent amount because programme duration is short.

The indicated consumption values may accordingly differ to local conditions.

Programme	Temperature in °C	Max. load	Energy	Water	Washing time	Spin drying performance
		in kg	in kWh	in L	in h:min	in %
		HW100/HW80	HW100/HW80	HW100/HW80	HW100/HW80	HW100/HW80
	40°C	5/4	0.48/0.48	34/34	3:25	53
Cotton+ *	60°C	5/4	0.56/0.56	34/34	3:28	53
	60°C	10/8	0.48/0.48	50/50	3:28	53
Synthetic	40	10/8			1:03	

* Standard programme for the Energy Labelling according to 2010/30 EU:

Cotton+ 60°C/40°C with max. spin speed setting and activated "Intense" function.

The standard 60°C and 40°C cotton programmes are suitable to clean normally soiled cotton laundry. They are the most efficient programmes in terms of combined energy and water consumption for cotton laundry. Used water temperature may differ from declared cycle temperature.



Note: Auto Weight

The appliance is equipped with a loading recognition. At low loading, energy, water and washing time will be reduced automatically in some programs. The display shows **Auto**

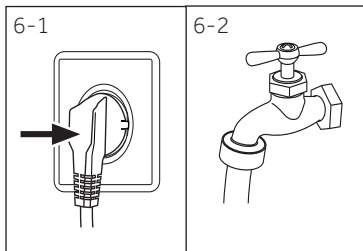

6.1 Power supply

Connect the washing machine to a power supply (220V to 240V~/50Hz; Fig. 6-1). Please refer also to section INSTALLATION.

6.2 Water connection

- ▶ Before connecting check the cleanliness and clarity of the water inlet.
- ▶ Turn on the tap (Fig.6-2).

i Note: Tightness

Before use check for leakage in the joints between the tap and the inlet hose by turning on the tap.

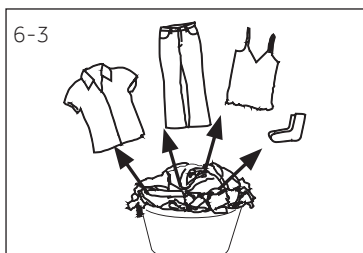

6.3 Preparing laundry

- ▶ Sort out clothes according to fabric (cotton, synthetics, wool or silk) and to how dirty they are (Fig. 6-3). Pay attention to the care labelling of washing labels.
- ▶ Separate white clothes from coloured ones. Wash coloured textiles first by hand to check if they fade or run.
- ▶ Empty pockets (keys, coins, etc.) and remove harder decorative objects (e.g. brooches).
- ▶ Garments without hems, delicates and finely woven textile such as fine curtains are to be put into a wash bag to care for this delicate laundry (hand or dry cleaning would be better).
- ▶ Close zippers, velco fastener and hooks, make sure the buttons are sewn on tightly.
- ▶ Place sensitive items like laundry without firm hem, delicate underwear (Dessous) and small items such as socks, belts, bras, etc. in a wash bag.
- ▶ Unfold large pieces of fabric such as bed sheets, bedspreads etc.
- ▶ Turn jeans and printed, decorated or color-intensive textiles inside out; possibly wash separately.



CAUTION!

Non-textile, as well as small, loose or sharp-edged items may cause malfunctions and damage of clothes and appliance.

Care chart

Washing					
	Washable up to 95°C normal process		Washable up to 60°C normal process		Washable up to 60°C mild process
	Washable up to 40°C normal process		Washable up to 40°C mild process		Washable up to 40°C very mild process
	Washable up to 30°C normal process		Washable up to 30°C mild process		Washable up to 30°C very mild process
	Wash by hand max. 40°C		Do not wash		
Bleaching					
	Any bleaching allowed		Only oxygen/non-chlorine		Do not bleach
Drying					
	Tumble drying possible normal temperature		Tumble drying possible lower temperature		Do not tumble dry
	Line drying		Flat drying		
Ironing					
	Iron at a maximum temperature up to 200°C		Iron at a medial temperature up to 150°C		Iron at a low temperature up to 110°C; without steam (steam ironing may cause irreversible damage)
	Do not iron				
Professional Textile Care					
	Dry cleaning in tetra-chloroethene		Dry cleaning in hydrocarbons		Do not dry clean
	Professional wet clean		Do not professional wet clean		

6.4 Loading the appliance

- ▶ Put in the laundry piece by piece
- ▶ Don't overload. Note the different maximum load according to programmes! Rule of thumb for maximum load: Keep six inches between load and drum top.
- ▶ Close the door carefully. Make sure that no pieces of laundry are pinched.

6.5 Selecting detergent

- ▶ Washing efficiency and performance is determined by used detergent quality.
- ▶ Use only machine wash approved detergent.
- ▶ If needed use specific detergents, e.g. for synthetic and woolen fabric.
- ▶ Mind always detergent manufacturer recommendations.
- ▶ Do not use dry cleaning agents such as trichloroethylene and similar products.

Choose the best detergent

Programme	Kind of detergent				
	Universal	Colour	Delicate	Special	Softener
Cotton	L/P	L/P	-	-	o
Mix	L/P	L/P	-	-	o
Synthetic	L/P	L/P	L	-	o
Under wear	-	-	-	L	o
Baby Care	L/P	L/P	-	-	o
Anti-allergy	L/P	L/P	L	-	o
Daily Wash	-	-	-	L	o
Sport	L/P	L/P	-	-	o
 Cotton+	L/P	L/P	-	-	o
Delicate	-	-	L	-	o
Duvet	-	-	L	L	o
Express 15 min	L/P	L/P	L	-	o
Hygienic	-	-	-	L	o
Wool	L/P	-	-	L	o
Self Clean	-	-	-	-	o
Spin/Drain	-	-	-	-	o

L = gel-/liquid detergent P = powder detergent O = optional - = no
 If using liquid detergent, it is not recommended to activate the time delay.

We recommend by using:

- ▶ Laundry powder: 20°C to 90°C* (best use:: 40-60°C)
- ▶ Color detergent: 20°C to 60°C (best use: 30-60°C)
- ▶ Wool/delicate detergent: 20°C to 30°C (= best use:)

* Choose 90 °C wash temperature only for special hygienic requirements.

6.6 Adding detergent

1. Slide out the detergent drawer.
2. Put the required chemicals into corresponding compartments (Fig. 6-4), refer to section 3.1 Detergent drawer.
3. Push back the drawer gently.

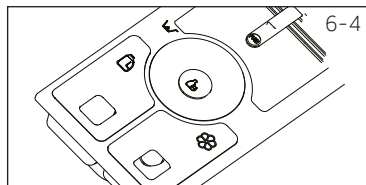

i Note:

- ▶ Remove detergent residues before next wash cycle from the detergent drawer.
- ▶ Do not overuse detergent or softener.
- ▶ Please follow the instruction on the detergent package.
- ▶ Always fill the detergent just before the beginning of the wash cycle.
- ▶ Concentrated liquid detergent should be diluted before adding.
- ▶ Do not use liquid detergent if function „Delay“ is selected.
- ▶ Carefully choose the programme settings according to the care symbols on all laundry labels and according to the programme table.

6.7 Switch on the appliance

Press the „on/off“- button for two seconds to switch on the appliance (Fig. 6-5). The LEDs of the button are shining.

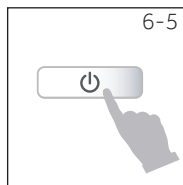

6.8 Select a programme

To get the best washing results, select a programme which fits the degree of soiling and sort of laundry type.

Turn the programme knob (Fig. 6-6) to select the right programme. Related programme LED lights up and the default settings are displayed.

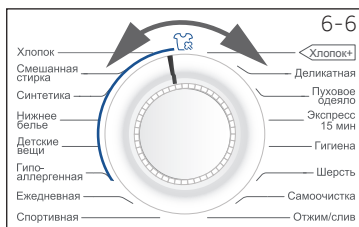

6.9 Add individual selections

Select required options and settings (Fig. 6-7); refer to CONTROL PANEL.





6.10 Start wash programme

Press "Start/Pause" button (Fig. 6-8) to start; appliance operates according to present settings. Changes are only possible by cancelling the programme.

6.11 Interrupt - cancel wash programme

To interrupt a running programme press gently "Start/Pause". Programme run-time is flashing. Press it again to resume operation.

To cancel a running programme and all its individual settings:

1. Press "Start/Pause" button to interrupt the running programme.
2. Press „On/Off" button for about three seconds to switch the appliance off.
3. Run programme SPIN + DRAIN to drain the water.
4. Select a new programme and start it.

Note: Door lock

- ▶ For safety reasons the door is locked partially during the washing cycle. It is only possible to open the door at the end of the programme or after the programme was cancelled correctly (see description above); "door is open"-symbol is displayed.
- ▶ In case of high water level, high water temperature and during spinning it is not possible to open the door; the "door lock"-symbol is displayed.

6.12 After washing

1. At programme cycle end **End** is displayed.
2. The appliance switches off automatically.
3. Remove laundry as soon as possible to go easy on it and to prevent more wrinkling.
4. Turn off the water supply.
5. Unplug the power cord.
6. Open the door to prevent formation of moisture and odours. Let it open while not used.

Note: Standby mode / energy-saving mode

The switched on appliance will go into standby mode if it will not be activated within two minutes before starting the programme or at the end of programme. The display switches off. This saves energy. To interrupt the standby-mode push one button.

6.13 Activate or deactivate the buzzer

The acoustic signal can be deselected if necessary:

1. Switch on the appliance.
2. Select the SPIN + DRAIN programme.
3. Press the "I-time" button and "Speed" button at the same time for about three seconds. **"bEEP OFF"** will be displayed and the buzzer will be deactivated.

For activating the buzzer press these two buttons at the same time again. **"bEEP ON"** will be displayed.



Environmentally responsible use

- ▶ To achieve best use of energy, water, detergent and time you should use the recommended maximum load size.
- ▶ Do not overload (hand width clearance above laundry).
- ▶ Apply exact dosages of each washing agent.
- ▶ Choose the lowest adequate washing temperature - modern detergents are efficiently cleaning below 60°C.
- ▶ Raise default settings only due to heavy staining.
- ▶ Select max. spinning speed if a domestic dryer is used.

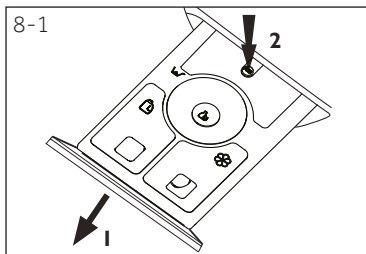

8.1 Cleaning the detergent drawer

Take always care there are no detergent residues. Clean the drawer regularly (Fig. 8-1):

1. Pull out the drawer until it stops.
2. Press the release button and remove the drawer.
3. Flush the drawer with water until it is clean and insert the drawer back in the appliance.



8.2 Cleaning the machine

- ▶ Unplug the machine during cleaning and maintenance.
- ▶ Use a soft cloth with soap liquid to clean the machine case (Fig. 8-2) and rubber components.
- ▶ Do not use organic chemicals or corrosive solvents.

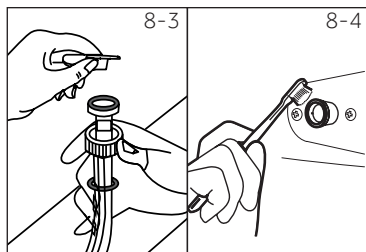

8.3 Water inlet valve and inlet valve filter

To prevent blockage of water supply by solid substances like lime clean regularly the inlet valve filter.

- ▶ Unplug the power cord and turn off the water supply.
- ▶ Unscrew the water inlet hose at the back (Fig. 8-3) of the appliance as well as on the tap.
- ▶ Flush the filters with water and a brush (Fig. 8-4).
- ▶ Insert the filter and install the inlet hose.

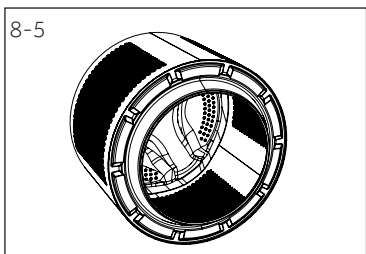

8.4 Cleaning the drum

- ▶ Remove accidentally washed metal parts such as pins, coins, etc. from the drum (Fig. 8-5) because they cause rust stains and damage.
- ▶ Use a non-chloride cleaner for removing rust stains. Observe the warning hints of the cleaning agent manufacturer.
- ▶ Do not use any hard objects or steel wool for cleaning.



Note: Hygiene

For regular maintenance, we recommend running the program SELF CLEAN within 100 cycles to avoid possible corrosive residues. Add a small amount of detergent to the detergent compartment (2) - or use a special machine cleaner. If you run more than 100 cycles and do not use the SELF CLEAN program, the SELF CLEAN program light flashes when the machine is in standby mode. It is recommended to run the SELF CLEAN .

8.5 Long periods of disuse

If the appliance is left idle for a longer period:

1. Pull out the electrical plug (Fig. 8-6).
2. Turn off water supply (Fig. 8-7).
3. Open the door to prevent formation of moisture and odours. Let door open while not used.

Before next usage check carefully power cord, water inlet and drain hose. Make sure everything is properly installed and without leakage.

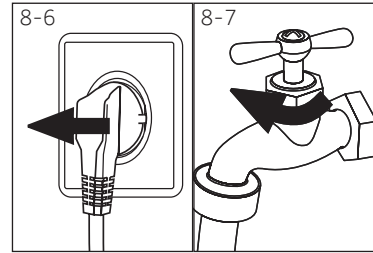

8.6 Pump filter

Clean the filter once a month and check the pump filter for instance if the appliance:

- ▶ doesn't drain the water.
- ▶ doesn't spin.
- ▶ cause unusual noise while running.



WARNING!

Scalding Risk! Water in the pump filter can be very hot! Before any action please ensure water has cooled down.

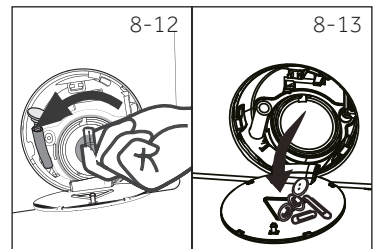
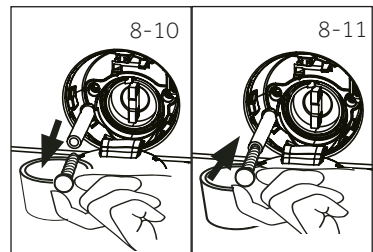
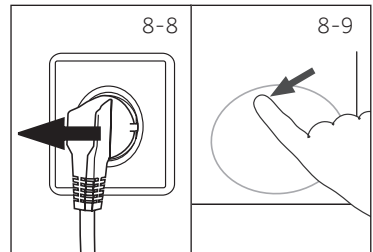

1. Turn off and unplug the machine (Fig. 8-8).
2. Open service flap at the right corner of appliance front (Fig. 8-9).
3. Provide a flat container to catch leach water (Fig. 8-10). There could be bigger amounts!
4. Pull the drainhose out and hold its end above the container (Fig. 8-10).
5. Take the sealing plug out of the drainhose (Fig. 8-10).
6. After complete drainage close drainhose and push it back into the machine (Fig. 8-11).
7. Unscrew and remove counter clockwise the pump filter (Fig. 8-12).
8. Remove contaminants and dirt (Fig. 8-13).

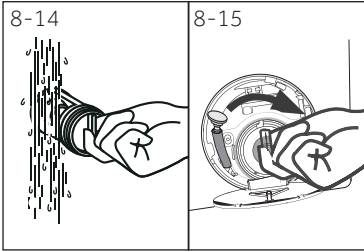

9. Clean carefully pump filter, e.g. using running water (Fig. 8-14).
10. Refix it thoroughly (Fig. 8-15).
11. Close service flap..



CAUTION!

- ▶ Pump filter sealing has to be clean and unhurt. If the lid is not full tightened, water can escape.
- ▶ The filter must be in place, or it may lead to leakage.

Many occurring problems could be solved by yourself without specific expertise. In case of a problem please check all shown possibilities and follow below instructions before you contact an after sales service. See CUSTOMER SERVICE.



WARNING!

- ▶ Before maintenance, deactivate the appliance and disconnect the mains plug from the mains socket.
- ▶ Electrical equipment should be serviced only by qualified electrical experts, because improper repairs can cause considerable consequential damages.
- ▶ A damaged power cable should only be replaced by the manufacturer, its service agent or similarly qualified persons in order to avoid a hazard.

9.1 Information codes

Following codes are displayed only for information referring to the washing cycle. No measures must be performed.

Code	Message
t:25	The remaining wash cycle time will be 1 hour and 25 minutes.
6:30	The remaining wash cycle time including chosen end-time delay will be 6 hours and 30 minutes.
Auto	Automatic load detection is working; only in some programs.
End	The washing cycle is finished. The appliance shuts off automatically.
Loc t	Door is closed because of high water level, high water temperature or spinning cycle.
bEEP ON	The buzzer is activated.
bEEP OFF	The buzzer is deactivated.

9.2 Troubleshooting with display code

Problem	Cause	Solution
E1	<ul style="list-style-type: none"> Drainage error, water is not fully drained within 6 minutes. 	<ul style="list-style-type: none"> Clean pump filter. Check drain hose installation.
E2	<ul style="list-style-type: none"> Lock - error. 	<ul style="list-style-type: none"> Shut the door properly.
E3	<ul style="list-style-type: none"> Temperature sensor - error. 	<ul style="list-style-type: none"> Contact the After sales service.
E4	<ul style="list-style-type: none"> Water level not reached after 12 minutes. Drain hose is self-siphoning. 	<ul style="list-style-type: none"> Make sure that tap is fully opened and water pressure is normal. Check drain hose installation.
F4	<ul style="list-style-type: none"> Heating error. 	<ul style="list-style-type: none"> Contact the After sales service.
F7	<ul style="list-style-type: none"> Motor - error. 	<ul style="list-style-type: none"> Contact the After sales service.
EB	<ul style="list-style-type: none"> Water protective level - error. 	<ul style="list-style-type: none"> Contact the After sales service.
FR	<ul style="list-style-type: none"> Water level sensor error. 	<ul style="list-style-type: none"> Contact the After sales service.
FE0 FE1 or FE2	<ul style="list-style-type: none"> Abnormal communication error. 	<ul style="list-style-type: none"> Contact the After sales service.
Unb	<ul style="list-style-type: none"> Unbalanced load - error. 	<ul style="list-style-type: none"> Check and balance laundry load in the drum. Reduce the load.
H	<ul style="list-style-type: none"> Temperature in the drum is higher than 80°C. 	<ul style="list-style-type: none"> Will release automatically if temperature is less than 80°C.

9.3 Troubleshooting without display code

Problem	Cause	Solution
Washing machine fails to operate.	<ul style="list-style-type: none"> • Programme is not yet started. • Door is not properly closed. • Machine has not been switched on. • Power failure. • Child lock is activated. 	<ul style="list-style-type: none"> • Check programme and start it. • Close the door properly. • Switch the machine on. • Check power supply. • Deactivate child lock.
Washing machine will not be filled with water.	<ul style="list-style-type: none"> • No water. • Inlet hose is kinked. • Inlet hose filter is blocked. • Water pressure is less than 0.03 MPa. • Door is not properly closed. • Water supply failure. 	<ul style="list-style-type: none"> • Check water tap. • Check inlet hose. • Unblock inlet hose filter. • Check water pressure. • Close the door properly. • Ensure the water supply.
Machine is draining while being filled.	<ul style="list-style-type: none"> • Height of drain hose is below 80 cm. • Drain hose end could reach into water. 	<ul style="list-style-type: none"> • Make sure that drain hose is properly installed. • Make sure the drain hose is not in water.
Drainage failure.	<ul style="list-style-type: none"> • Drain hose is blocked. • Pump filter is blocked. • Drain hose end is higher than 100 cm above floor level. 	<ul style="list-style-type: none"> • Unblock drain hose. • Clean pump filter. • Make sure that drain hose is properly installed.
Strong vibration while spinning.	<ul style="list-style-type: none"> • Not all transportation bolts have been removed. • Appliance has no solid position. • Machine load is not correct. 	<ul style="list-style-type: none"> • Remove all transportation bolts. • Ensure solid ground and a levelled position. • Check load weight and balance.
Operation stops before completing wash cycle.	<ul style="list-style-type: none"> • Water or electric failure. 	<ul style="list-style-type: none"> • Check power and water supply.
Operation stops for a period of time.	<ul style="list-style-type: none"> • Appliance displays error code. • Problem due to load pattern. • Programme performs soaking cycle? 	<ul style="list-style-type: none"> • Consider display codes. • Reduce or adjust load. • Cancel programme and restart.
Excessive foam floats drum and/or detergent drawer.	<ul style="list-style-type: none"> • Detergent is not appropriate. • Excessive use of detergent. 	<ul style="list-style-type: none"> • Check detergent recommendations. • Reduce amount of detergent.
Automatic adjustment of washing time.	<ul style="list-style-type: none"> • Washing programme duration will be adjusted. 	<ul style="list-style-type: none"> • This is normal and doesn't affect functionality.
Spinning fails.	<ul style="list-style-type: none"> • Unbalance of laundry. 	<ul style="list-style-type: none"> • Check machine load and laundry and run a spinning programme again.

Problem	Cause	Solution
Unsatisfactory washing result.	<ul style="list-style-type: none"> Degree of pollution does not agree with selected programme. Detergent quantity was not sufficient. Maximum load has been exceeded. Laundry was unevenly distributed in the drum. 	<ul style="list-style-type: none"> Select an other programme. Choose the detergent acc.to the degree of pollution and acc. to manufacturer specifications. Reduce loading. Loose the laundry.
Washing powder residues are on the laundry.	<ul style="list-style-type: none"> Insoluble particles of detergent can remain as white spots on the laundry. 	<ul style="list-style-type: none"> Perform extra rinse. Try to brush the points from the dry laundry. Choose an other detergent.
Laundry has grey patches.	<ul style="list-style-type: none"> Caused by fats such as oils, creams or ointments 	<ul style="list-style-type: none"> Pretreat the laundry with a special cleaner.

Note: Foam formation

If too much foam is inspected during spin cycle, motor stops and drain pump will be activated for 90 seconds. If that elimination of foam fails up to 3 times, programme ends without spinning.

Should the error messages reappear even after the taken measures, switch off the appliance, disconnect the power supply and contact the customer service.

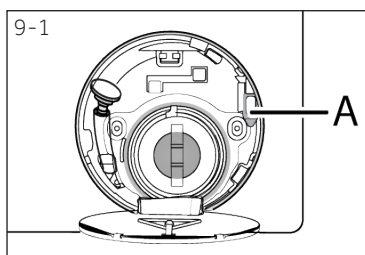

9.4 In case of power failure

The current programme and its setting will be saved. When power supply is restored operation will be resumed.

If a power failure cuts an operating wash programme door opening is mechanically blocked. To get out any laundry water level should not be seen in the glassy porthole of the door. - Danger of burns! Water level has to be lowered as described in "Pump filter". Not till then pull lever (A) beneath service flap (Fig. 9-1) until door is unlocked by a gentle click. Afterwards refix all parts.

10.1 Preparation

- ▶ Take the appliance out of the packaging.
- ▶ Remove all packaging material including protecting film on cabinet, polystyrene base, keep them out of childrens reach. While opening the package, water drops may be seen on plastic bag and porthole. This normal phenomenon results from water tests in the factory.



Note: Packaging disposal

Keep all packaging materials out of children’s reach and dispose them in an environmentally friendly manner.

10.2. OPTIONAL: Install noise reduction pads

1. When opening the shrink package, you will find four noise reduction pads. These are used for reducing noise. (Fig. 10.1)
2. Lay the washing machine down to its side, porthole pointing upwards, bottom side towards operator.
3. Take out the noise reduction pads and remove the double-sided adhesive protective film; Paste around the bottom; The noise reduction pads under the washing machine cabinet as shown in Figure 3. (two longer pads in position 1 and 3, two shorter pads in position 2 and 4). Finally set the machine upright again.

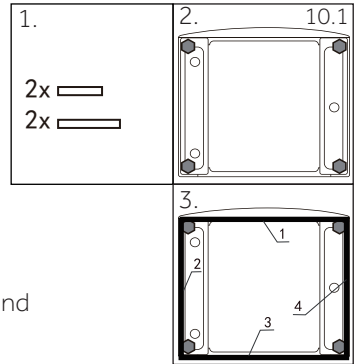

10.3 Dismantle the transport protection

The transport protection on the rear side is designed for clamping anti-vibration components inside the appliance during transportation to prevent inner damage. All elements (I, R, S and T, fig. 10-2) must be removed before use:

1. Remove all 4 bolts (T1-T4) (Fig. 10-3).

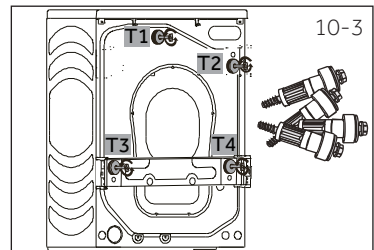
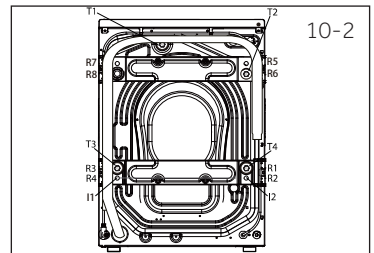

- Remove the 8 screws (R1-R8) from lower back reinforcement.*HW100-B14876
Remove the 4 screws (R1-R4) from lower back reinforcement.*HW80-B14876 (Fig. 10-4) and put aside.

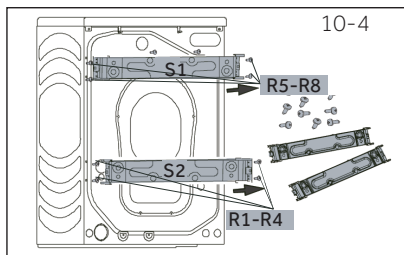

- Pull out the 2 iron bars I1 and I2 (Fig. 10-5).

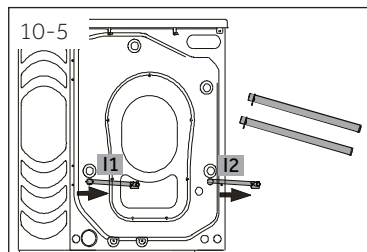
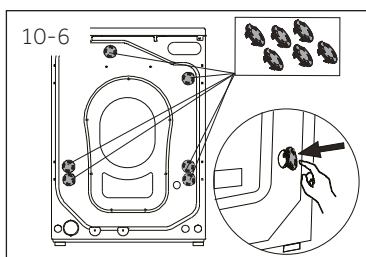

- Fill the 6 left holes with blanking plugs (Fig. 10-6).

Note: Keep in safe place

Keep all parts of the transport protection in a safe place for later use. Whenever the appliance is to be moved at first reinstall the protection parts.

10.4 Moving the appliance

If the machine is to be moved to a distant location, replace the transport protection before installation to prevent damage. The assembly takes place in reserve order.

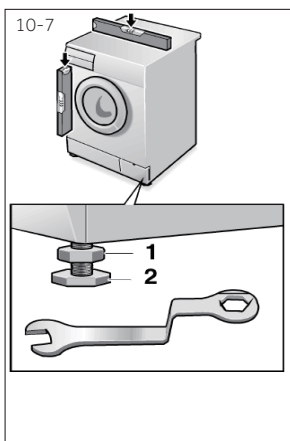

10.5 Aligning the appliance

Adjust all feet (Fig. 10-7) to achieve a complete level position. This will minimize vibrations and thus noise during use. It will also reduce wear and tear. We recommend to use a spirit level for adjustment. Floor should be as stable and flat as possible.

- Loose the locknut (1) by using a wrench.
- Adjust the high by turning the foot (2).
- Tighten locknut (1) against the housing.

10.5 Drain Water Connection

Fix the water drain hose properly to the piping. The hose has to reach at one point a height between 80 and 100 cm above the appliance bottom line! If possible keep always drain hose fixed to the clip at the appliance back.



WARNING!

- ▶ Use only the supplied hose set for the connection.
- ▶ Never reuse old hose sets!
- ▶ Only connect to cold water supply.
- ▶ Before connection, check whether the water is clean and clear.

Following connections are possible:

10.6.1 Drain hose to sink

- ▶ Hang the drain hose with the U-support over the edge of a sink with adequate size (Fig. 10-8).
- ▶ Protect the U-support sufficiently against slipping.

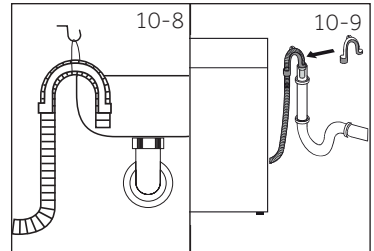

10.6.2 Drain hose to waste water connection

- ▶ The internal diameter of the stand pipe with vent-hole must be minimum 40 mm.
- ▶ Put the drain hose for approx. 80 mm in the wastewater pipe.
- ▶ Attach the U-support and secure it sufficiently (Fig. 10-9).

10.6.3 Drain hose to sink connection

- ▶ The junction must lie above the siphon
- ▶ A spigot connection is usually closed by a pad (A). That must be removed to prevent any disfunction (Fig. 10-10).
- ▶ Secure the drain hose with a clamp.

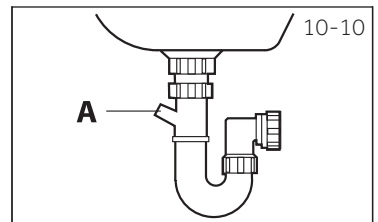

CAUTION!

- ▶ The drain hose should not be submerged in water and should be securely fixed and leak-free. If the drain hose is placed on the ground or if the pipe is at a height of less than 80 cm, the washing machine will continuously drain while being filled (self-siphoning).
- ▶ Drain hose is not to be extended. If necessary contact after sales service.

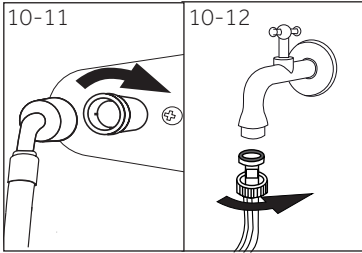

10.6 Fresh Water Connection

Make sure that the gaskets are inserted.

1. Connect the water inlet hose with the angled end to the appliance (Fig. 10-11). Tighten the screw joint by hand.
2. The other end connect to a water tap with a 3/4" thread (Fig. 10-12).

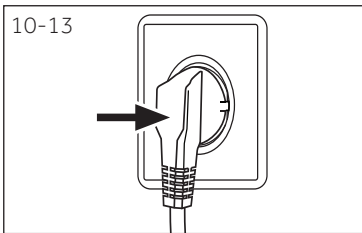

10.7 Electrical Connection

Before each connection check if:

- ▶ power supply, socket and fusing are appropriate to the rating plate.
- ▶ the power socket is earthed and no multi-plug or extension are used.
- ▶ the power plug and socket are strictly according.
- ▶ **Only UK:** The UK plug meets BS1363A standard.

Put the plug into the socket (Fig. 10-13).



WARNING!

- ▶ Ensure always that all connections (power supply, drain and fresh water hose) are firm, dry and leak free!
- ▶ Take care these parts are never to be crushed, kinked, or twisted
- ▶ If the supply cord is damaged, it must be replaced by the service agent (see warranty card) in order to avoid a hazard. .

-
-
-

11.1 Product fiche according to regulation EU No. 1061/2010

Suppliers name or trade mark	Haier	
Supplier's model identifier	HW80-B14876	HW100-B14876
Rated capacity (kg)	8	10
Energy efficiency class	A+++	A+++
Energy consumption per year (AE _c in kWh/year) ¹⁾	115	115
Energy consumption of standard cotton programme 60°C, full load (kWh/cycle)	0.48	0.48
Energy consumption of standard cotton programme 60°C, partial load (kWh/cycle)	0.56	0.56
Energy consumption of standard cotton programme 40°C, partial load (kWh/cycle)	0.48	0.48
Weighted power consumption of the off mode (W)	0.48	0.48
Weighted power consumption of the left-on mode (W)	0.48	0.48
Water consumption per year (AW _c in L/year) ²⁾	8954	8954
Spin-drying efficiency class ³⁾	B	
Max. spin speed (rpm) ⁴⁾	1400	
Remaining moisture content (%) ⁴⁾	53	
Standard 60°C cotton programme ⁵⁾	Cotton+ + 60°C + max. spin	
Standard 40°C cotton programme ⁵⁾	Cotton+ + 40°C + max. spin	
Programme time of cotton 60°C full load (min)	208	208
Programme time of cotton 60°C partial load (min)	208	208
Programme time of cotton 40°C partial load (min)	205	205
Duration of the left-on mode (T _i in min) ⁶⁾	3	
Airborne accoustical noise (washing/spinning) in dB(A) re 1pW ⁷⁾	58/71	58/71
Type	freestanding	

1) Based on 220 standard washing cycles for cotton programmes at 60°C and 40°C at full and partial load, and the consumption of the low-power modes. Actual energy consumption will depend on how the appliance is used.

2) Based on 220 standard washing cycles for cotton programmes at 60°C and 40°C at full and partial load. Actual water consumption will depend on how the appliance is used.

3) Class G is the least efficiency and Class A is the most efficient.

4) Based on the standard 60°C cotton programme at full load and the standard 40°C cotton programme at partial load.

5) "Standard 60°C cotton programme" and "standard 40°C cotton programme" are standard washing programmes to which the information in the label and fiche relates. These programmes are suitable to clean normally soiled cotton laundry and they are the most efficient programmes in terms of combined energy and water consumption.

6) In case there is a power management system.

7) Based on the standard 60°C cotton programme at full load.

11.2 Additional technical data

	HW80-B14876	HW100-B14876
Dimension (HxDxW in mm)	845x460x595	845x530x595
Dimension (D in mm)	510	600
Voltage in V	220-240 V~/50Hz	
Current in A	10	
Max power in W	1950	
Water pressure in MPa	0.03≤P ≤1	
Netto weight in kg	72	77

11.3 Standards and Directives

This product meets the requirements of all applicable EC directives with the corresponding harmonised standards, which provide for CE marking.

We recommend our Haier Customer Service and the use of original spare parts.
If you have a problem with your appliance, please first check section TROUBLESHOOTING.

If you cannot find a solution there, please contact

- ▶ your local dealer or
- ▶ the Service & Support area at www.haier.com where you can find telephone numbers and FAQs and where you can activate the service claim.

To contact our Service, ensure that you have the following data available.
The information can be found on the rating plate.

Model _____ Serial No. _____

Also check the Warranty Card supplied with the product in case of warranty.

For general business enquiries please find below our addresses in Europe:

European Haier addresses			
Country*	Postal address	Country*	Postal address
Italy	Haier Europe Trading SRL Via De Cristoforis, 12 21100 Verese ITALY	France	Haier France SAS 3-5 rue des Gravieres 92200 Neuilly sur Seine FRANCE
Spain Portugal	Haier Iberia SL Pg. Garcia Faria, 49-51 08019 Barcelona SPAIN	Belgium-FR Belgium-NL Netherlands Luxembourg	Haier Benelux SA Anderlecht Route de Lennik 451 BELGIUM
Germany Austria	Haier Deutschland GmbH Hewlett-Packard-Str. 4 D-61352 Bad Homburg GERMANY	Poland Czechia Hungary Greece Romania Russia	Haier Poland Sp. zo.o. Al. Jerozolimskie 181B 02-222 Warszawa POLAND
United Kingdom	Haier Appliances UK Co.Ltd. One Crown Square Church Street East Woking, Surrey, GU21 6HR UK		

*For more information please refer to www.haier.com



Haier

0020508374Z