

# **Hisense**

# USER MANUAL

Read the manual carefully and ensure you have fully understood its contents before operating this device for the first time.

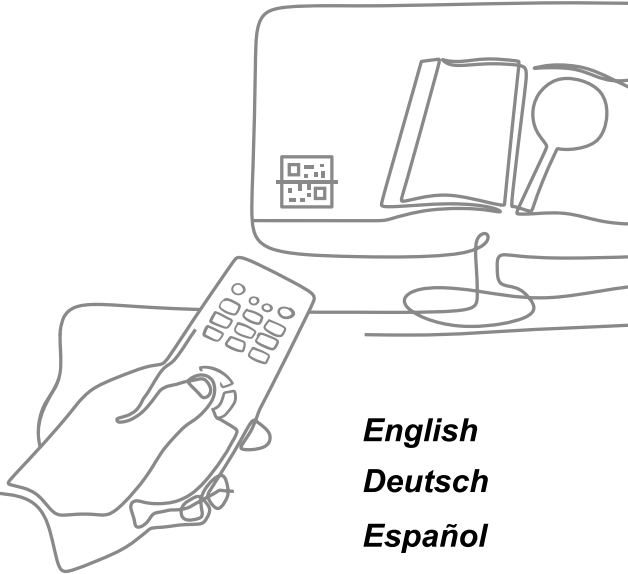

**English**  
**Deutsch**  
**Español**  
**Italiano**  
**Português**  
**Français**  
**Nederlands**

Figures and illustrations in this manual are provided for reference only and may differ from actual product appearance.

Parts of the software function changes with the system upgrade.



## Contents

Installation .....	1
Appearance and Connection .....	3
Remote Control .....	5
Specifications .....	7
Other Information.....	8

## Find the E-Manual

This TV is equipped with a user manual and embedded E-Manual (**Settings > Support > E-Manual** or **Settings > All Settings > Support > E-Manual**).

### E-Manual support functions

 <b>Search</b> Find the help you are looking for.	 <b>Try Now</b> Go directly to the function page and try it.	 <b>QR Code</b> Scan to open the E-Manual on your mobile device.
---	--	--

## Accessories List

The following accessories are included with TV:

User Manual × 1	Base Stand × 2	Screw × 4	AAA Battery × 2
Remote Control × 1	Power Cord × 1	Warranty Card × 1	
Nut × 2 (for installing the wall mount bracket)(50")			

### NOTE

- The accessories may be different from the list above due to different models, countries / regions. Please refer to the actual accessory bag.

## Important Notice

Paragraphs beginning with the symbol  indicate important instructions, tips or conditions for the following settings.

 **For your own safety and the optimal performance of your TV, ensure to read the safety instructions before performing any installation.**

Compatibility with 3rd party products, software and services are not guaranteed. We cannot be held liable for any damage or loss suffered whilst operating, using or connecting to incompatible devices or apps.

The recording and playback of content on this or any other device may require permission from the owner of the copyright or other such rights in that content. It is your responsibility to ensure that your use of this or any other device complies with applicable copyright legislation in your country. Please refer to that legislation for more information on the relevant laws and regulations involved or contact the owner of the rights of the content you wish to record or playback.

**Read these instructions**  
**Follow all instructions**  
**Heed all warnings**  
**Keep these instructions**



All rights reserved.

Hereby, Hisense Visual Technology Co., Ltd. declares that the radio equipment type is in compliance with Directive 2014/53/EU and Radio Equipment Regulations 2017 of UK. Please enter the model name at the following internet address to read the full text of the declaration of conformity: <https://www.hisense.com/global/certificate-download.html>

Please refer to the rating label for TV model name and find Bluetooth remote control model name on the remote control or inside the remote control cover.

Authorized EU Representative

Name: Gorenje gospodinjski aparati, d.o.o.

Address: Partizanska cesta 12, 3320 Velenje, Slovenija

Email: [info@gorenje.com](mailto:info@gorenje.com)

## Safety Instructions

To ensure safe and correct use of this product, always comply with the following precautions to avoid dangerous situations and damage to your unit:

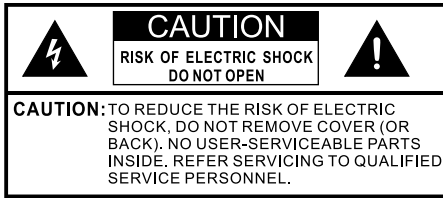

The lightning flash with arrowhead symbol, within an equilateral triangle is intended to alert the user to the presence of uninsulated dangerous voltage within the product's enclosure that may be of sufficient magnitude to constitute a risk of electric shock.



The exclamation point within an equilateral triangle is intended to alert the user to the presence of important operating and maintenance (servicing) instructions in the literature accompanying the appliance.

### The intended use and ambient conditions for this TV

This TV is intended for the rendering of video and audio signals, on a table-top or wall-mounted, in a home or office environment. It must not be used in rooms with a high level of humidity or dust concentration. The warranty is only valid if used as intended by the manufacturer.



#### WARNING

**High humidity and dust concentration may lead to current leaks in the device. To reduce the risk of fire or electrical shock:**

- Do not expose this unit to rain, moisture, dripping or splashing water, and do not place objects filled with liquids, such as vases, cups, etc. on or over the unit.
- Do not touch the TV with wet hands.
- Do not expose to direct air-conditioning and keep candles or other naked flames away from the TV at all times.

If the TV is moved from a cold environment to a hot environment, leave it switched off for at least an hour to avoid condensation. If used outside, make sure it is protected from moisture.

If you notice anything unusual, immediately remove the power plug.

In case of fire, use preferably a CO<sub>2</sub> gas or powder fire extinguisher. If such extinguishers are not accessible, try to isolate the electrical supply before using a water fire extinguisher.

#### WARNING

#### Stability Hazard

A television set may fall, causing serious personal injury

or death. Many injuries, particularly to children, can be avoided by taking simple precautions such as:

- ALWAYS use cabinets or stands or mounting methods recommended by the manufacturer of the television set.
- ALWAYS use furniture that can safely support the television set.
- ALWAYS ensure the television set is not overhanging the edge of the supporting furniture.
- ALWAYS educate children about the dangers of climbing on furniture to reach the television set or its controls.
- ALWAYS route cords and cables connected to your television so they cannot be tripped over, pulled or grabbed.
- NEVER place a television set in an unstable location.
- NEVER place the television set on tall furniture (for example, cupboards or bookcases) without anchoring both the furniture and television set to a suitable support.
- NEVER place the television set on cloth or other materials that may be located between the television set and supporting furniture.
- NEVER place items that might tempt children to climb, such as toys and remote controls, on the top of the television or furniture on which the television is placed.

If your existing television set is being retained and relocated, the same considerations as above should be applied.

#### ■ Moving/Transportation

Before moving this TV, disconnect all cables and move in the vertical position only. Grasp the device on the upper and lower edges of the frame.

- Do not press or put stress on the front panel of the TV. It may take two or more people to carry larger TVs.

If you have to briefly lay down the TV, place the unit with its entire front surface lying flat on soft material.

The LED screen is made of glass and can break if is not handled properly. Always wear rubber gloves to carry the unit. If the LED screen is damaged, liquid crystal might leak out. In case of skin contact, immediately rinse thoroughly with water.

#### ■ Power Supply

Incorrect voltages can damage the TV. Only connect this unit to a power supply with the correct voltage and frequency noted on the type plate, using the supplied power cable.

The power plug must be easily accessible so that the device can be disconnected at all time. The unit is live, even if in standby mode, as long as the unit is connected to a power outlet.

It is recommended that this unit is placed on a dedicated circuit.

- Do not overload the power outlets by connect too many appliances to the same outlet. Overloaded wall outlets, extension cords, etc. are dangerous and can result in electric shock and fire.

- Switch off the television after use and unplug it if it is not going to be used for.

After power off, don't turn it on again in 5 seconds. Frequent switching power supply in a short period of time can cause abnormal TV.

#### ■ Power plug and power cable

- Do not touch the power plug with wet hands.
- Do not place heavy objects on the power cable. Route the cable so that it is not kinked or laid over sharp edges, walked on or exposed to chemicals. A power cable with damaged insulation can cause electric shock and fire.
- Pull the power plug, NOT on the cable when disconnecting. The cable can become damaged and cause a short circuit if pulled on.
- Do not place the power cable near a high temperature object.
- Do not move the TV with the power cable plugged into a socket.
- Do not use a damaged or loose power cable, or a damaged socket outlet.
- Do not use any power cords other than the one supplied with this unit.
- MAIN plug on the power cord is used as the disconnect device, the disconnect device and socket-outlet shall be easily accessible.

#### ■ Set-up

Check that the location is suitable to bear the load of the TV. Place on a level, sturdy and horizontal base. Ensure that the unit does not hang over the edge of the base when placed in or on furniture. If placed on a cart, use caution when moving to avoid the unit from tipping over.

- Choose a good location for the television, in a clean place, away from sources of heat (sun, radiators, fireplaces), plants (pollen, dust, water) and the ground (risk of knocks, dust).
- Place the unit in a normal upright horizontal position. It must never be operated vertically, lying flat or hanging overhead from the ceiling.

When mounting the TV on a wall, follow the instructions supplied with the wall-mount, make sure not to install the TV by hanging the power and signal cables on the back of the TV.

#### ■ Air ventilation and high temperatures

Install your TV only where there is proper ventilation, and ensure that there is at least 10 cm free space on the sides and 20 cm above the unit for air circulation. Excessive heat and obstruction of ventilation could lead to fire or early failure of some electric components.

- Do not place cloth, paper or other materials over the openings on the top, sides or bottom of the appliance.
- Take care not to touch the ventilation openings since they may become hot.
- Do not insert foreign objects into the TV through the vents.

#### ■ The Stand

- Do not use any stand other than the one supplied with this unit.

- Do not modify or use the stand if it becomes warped or physically damaged.
- During setup, make sure that all the screws are securely tightened.
- Ensure that the TV does not suffer any impact during the attachment of the stand.
- Ensure that children do not climb onto the stand.
- Attach or remove the stand with at least two people.

Prevent small items from getting into the interior of the device through the ventilation slots. Such objects may cause short circuits, which may cause fire.

If something should get inside the unit, immediately unplug the power plug of the device and contact service support.

#### ■ The LED screen

Despite thorough care when manufacturing this display, it cannot be 100% guaranteed that no sub-pixel defects will occur due to technical reasons. These cannot be considered as a device defect in terms of the guarantee. They will not affect the performance and reliability of the TV.

To prevent "image burn", avoid displaying still images for long periods of time, there is a possibility that a copy of the image may remain. If the aspect ratio is set to 4:3 for a long period of time, image burn may occur on the black areas. Image burn is not covered by the warranty.

- Do not apply strong force or impact on the display panel.

Avoid touching the LED screen or touching it for long periods of time. Doing so may produce some temporary distortion effects on the screen.

#### ■ Radio waves

- Do not use the TV in any medical institutions or locations with medical equipment. Radio waves may interfere with medical equipment and cause malfunction.
- Do not use the TV near any automatic control equipment such as automatic doors or fire alarms. Radio waves may interfere with automatic control equipment and cause malfunction.

If you have a cardiac pacemaker, keep a distance of at least 22 cm from the TV. Radio waves may interfere with the operation of a pacemaker.

#### ■ Built-in wireless LAN

- Do not connect to wireless networks that you do not have the usage rights for. Data transmitted and received over radio waves may be intercepted and monitored.

The built-in wireless LAN uses 2.4 GHz and 5 GHz frequency band. To avoid malfunctions or slow response caused by radio wave interference, keep the TV away from devices such as other wireless LAN devices, microwaves, mobile phones, and other devices that use 2.4 GHz and 5 GHz signal.

#### ■ Warning about off-gassing

New furniture, carpet, paint, building materials and electronics can release chemicals into the air through evaporation. After you set your TV up and turn it on

for the first time, you may notice a slight smell within a couple of hours. This is because some components of TV are heating up for the first time. The materials that we use fully meet the environmental requirements and regulations. Your TV is working just fine and the fumes from the off-gassing will diminish eventually.

#### ■ **Supervision**

- Do not let children play unsupervised close to the TV. It could tip over, be pushed off or pulled down from the stand surface and injure someone.
- Do not allow a switched-on TV to run unattended.

#### ■ **Volume**

Loud music and noises can lead to irreversible damage to your ears. Avoid extreme volume, especially over long periods and when using headphones.

If you hear a drumming noise in your ears, turn down the volume or temporarily stop using headphones.

#### ■ **Thunder Storms**

Pull out the power plug and all connected antenna cables from the TV during a thunderstorm. Overvoltage caused by lightning strikes can damage the TV via the antenna system, as well as the wall socket.

#### ■ **Long periods of absence**

As long as the power plug is connected to a live socket outlet, the TV will consume power even in standby mode. The power plug and all connected antenna cables should be disconnected out during long periods of absence.

#### ■ **Cleaning and care**

##### **CAUTION:**

##### **Unplug the power cord prior to cleaning the TV.**

Clean the screen with a soft, dry cloth after switching off and unplugging the television. And avoid glass sprays and other household cleaning agents. Do not use any chemicals.

- Do not subject the surfaces to insect repellent, solvent, thinner or other volatile substances. This may degrade the surface quality.
- Do not spray water or other liquids directly on the TV. Liquid inside the TV could lead to product failure.
- The surface of the display panel is treated and may be easily damaged. Take care not to scratch it with fingernails or other hard objects.
- Also wipe the power plug with a dry cloth at regular intervals.

#### ■ **Service/Repair**

Never remove the cover/back of the TV; there are no user serviceable parts inside. Refer all service to qualified service personnel.

#### ■ **Packaging**

Keep the anti-moisture materials and plastic bags out of reach of children.

Plastic bags can cause suffocation and the anti-moisture material is harmful if swallowed. If swallowed by mistake, force the patient to vomit and visit the nearest hospital.

#### ■ **Modification**

Do not attempt to modify this product in any way. Unauthorised modification could void the warranty of this unit, cause electric shock and fires.

#### ■ **Remote Control batteries**

- Store the remote control carefully, do not expose it to liquids and check the condition of the remote control batteries regularly to prevent corrosion of the contacts.
- Incorrect installation may cause battery leakage, corrosion and explosion.
- Replace only with the same or equivalent type.
- Do not mix old and new batteries.
- Do not mix different battery types.
- Do not use rechargeable batteries.
- Do not burn or break up batteries.
- Be sure to dispose of batteries correctly.
- Do not expose batteries to excessive heat such as sunshine, fire or the like.

#### ■ **Outdoor Antenna Grounding**

If an outdoor antenna used, be sure the antenna system is protected against voltage surges and built-up static charges.

#### ■ **Disposal**

Refer to the recycling section of this manual.



AC voltage: This symbol indicates that the rated voltage marked with the symbol is AC voltage.



Class II product : This symbol indicates that it does not require a safety connection of protective earthing (ground).

# Installation

## ⚠ CAUTION

- Be sure to disconnect the AC power cord before installing a stand or wall mount brackets.
- The display on your TV is fragile. Make sure the TV screen is not scratched or damaged by hard objects or from pressure.
- After the installation is completed, make sure the TV is steady on a table or firmly attached to a wall mount, before removing all protective film, if any.

### ► Installing the stand

Follow the illustrations and textual instructions below to complete the installation steps:

1. Carefully place your TV face-up on a soft, flat surface to prevent damage to the TV or scratching to the screen.
2. Take out the 2 stands and then insert the stands into the bottom slots of the TV.
3. Secure the stands to the TV with the 4 screws in accessory tightly.

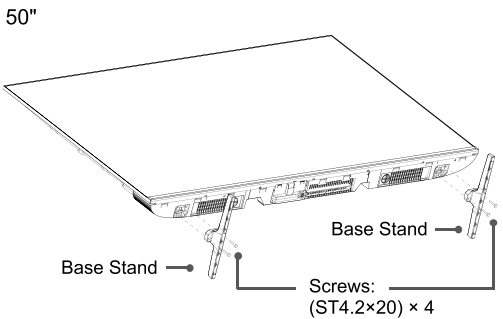
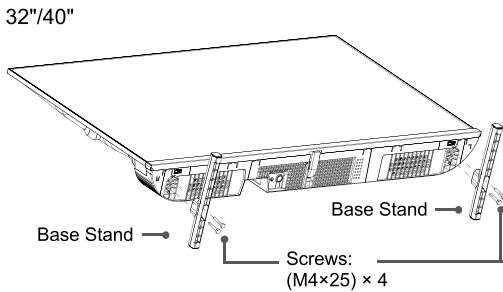

## ► Installing the wall mount bracket

Before you follow the third-party manufacturer instructions to attach the wall mount, be sure to do the following things:

1. Place the TV on a clean, safe and cushioned surface.
2. Remove the TV stands if you have already attached them.
3. Take the nuts out of the accessory bag and tighten the nuts into the holes of the back cover (See Fig.1).(only for 50")
4. Place spacers (not included) between the TV and the bracket (See Fig.2).

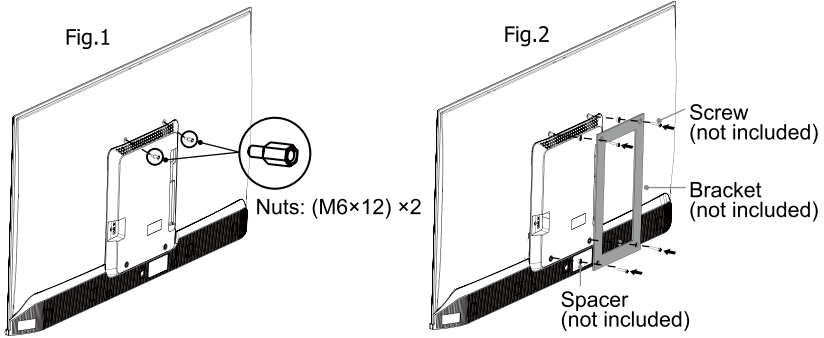

### ⚠ CAUTION

When mounting the TV on a wall, follow instructions provided with the wall mount bracket. If it is not correctly mounted, the TV may fall and cause property damage or personal injury.

- Place spacers between the TV and bracket.
- Standard dimensions are shown below.

Wall mount hole pattern (mm)	100 × 100 (32")
	100 × 200 (40")
	200 × 400 (50")
Wall mount screw size	M6
Number of wall mount screw	4

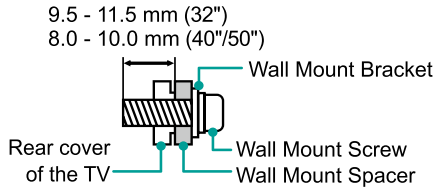

- We do not recommend hanging the TV on a slanted wall, and when wall mounting make sure your television remains parallel to the wall and does not lean forward.

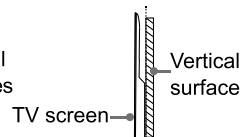

### 📌 NOTE

- The diameter and length of the screws differ depending on the wall mount bracket model.
- Wall mount bracket is optional. Your TV may not have wall mount bracket. Please refer to the actual accessories.

# Appearance and Connection

32"/40"

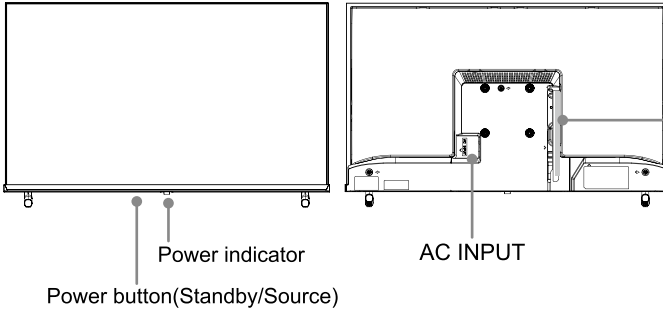

50"

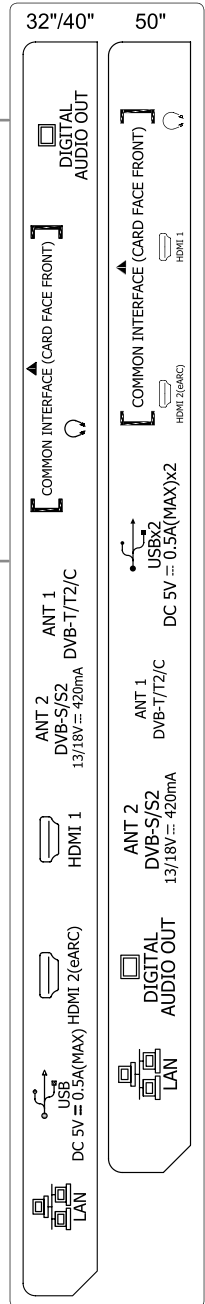
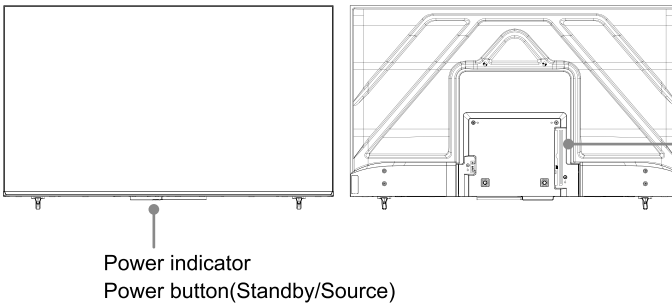

## NOTE

- ANT2 Jack supports power supply for satellite antenna (13/18V, 420mA max).
- Powering on the TV requires several seconds to load programmes. Do not rapidly turn the TV off as it may cause the TV work abnormally.
- The Picture is Only for Reference.













<b>Item</b>	<b>Description</b>
<b>Power indicator</b>	The light is white in standby mode.
<b>Power button (Standby / Source)</b>	Press the button to turn the TV on. Press it again to bring up the control menu and move the focus between different inputs. Long press the button to make a selection.
<b>ANT (DVB-T/T2/C)</b>	Connect an outdoor VHF/UHF antenna or cable.
<b>ANT (DVB-S/S2)</b>	Connect an outdoor Satellite antenna.
<b>HDMI</b>	Connect an HDMI cable from an external equipment.
<b>HDMI (eARC)</b>	Connect an HDMI cable from an external digital audio system. Please note that it works only when the TV is connected to the audio receiver that supports the eARC function.
<b>USB</b>	<p>Connect a USB device for browsing photos, listening to music and watching movies.</p> <p><b>Note:</b></p> <ul style="list-style-type: none"> <li>When connecting a hard disk or a USB hub, always connect the mains adapter of the connected device to the power supply. If a USB 1.1 or USB2.0 device requires more than 500mA or 5V, the USB device may not be supported. Max supported current for USB 3.0 device is 1A (only for some models). Exceeding the max supported current may result in damage or data loss.</li> <li>Certain digital cameras may not be compatible with the TV.</li> </ul>
<b>DIGITAL AUDIO OUT</b>	Connect an optical cable from an external digital audio system.
<b>LAN</b>	Connect an Ethernet cable to access a network or the Internet.
<b>COMMON INTERFACE</b>	<p>Insert the CI+ module for watching scrambled services like pay-tv channels or some HD channels.</p> <p><b>Note:</b></p> <ul style="list-style-type: none"> <li>Do not repeatedly insert or remove the Common Access Module as this may damage the interface and cause a malfunction.</li> <li>You must obtain a CI+ module and card from the service provider of the channels you want to watch.</li> <li>CI+ is not supported in some countries and regions.</li> </ul>
<b>HEADPHONE</b>	<p>Connect headphones to listen to the sound coming from the TV.</p> <p><b>Note:</b> Excessive sound pressure from earphones can cause hearing loss.</p>

#### **NOTE**

- Check the jacks for position and type before making any connections. Loose connections can result in image or colour problems. Make sure that all connections are tight and secure.
- Not all A/V devices have the ability to connect to a TV, please refer to the user's manual of your A/V device for compatibility and connections procedure.
- Before connecting external equipment, remove the mains plug from the wall socket. Otherwise, it may cause electric shock.
- The location and names of the terminals on the TV may vary according to TV model, and not all terminals available on all models.

# Remote Control

## ▶ Buttons of remote control

<b>BUTTON</b>	<b>DESCRIPTION</b>
	Power on/Standby
INPUT / 	Select input sources
APP	Quick access buttons to APP
Four colour buttons	Special function buttons
	Custom button to launch contents quickly
	Press to enter Menu
	Playpad keys
^ / v / < / >	D-pad (up/down/left/right navigation buttons); when watching TV programmes, press left or right button to display the current programme information
OK	Confirmation button
	Under the Menu or App, return to the previous place
	Display the Home screen
EXIT	Exit the menu or exit the application
SUB.	Activate or deactivate the subtitle mode
VOL	Volume (up/down)
CH	Channel (up/down)
	Mute and restore sound For some models, long press to be used as SUBTITLE
Number button	Select a channel or input numbers
GUIDE	Display the Electronic Program Guide (DTV mode); for models with  button, long press to be used as CH.LIST
CH.LIST	Display the Channel List on the screen
TEXT	Turn on/off the teletext function; for models with  button, long press to be used as INFO
INFO	Display the current program information; for models with  button, long press to be used as TEXT
	Fast access to search
HomeOS	Open HomeOS experience
	Activate AI assistant. This feature cannot be enabled in some scenarios

## NOTE

- The included remote control will vary depending on model, country/region. Check information according to the actual remote control in the accessory bag.
- Buttons listed here are for reference only. Actual remote control may vary depending on model, country/region.

## ► Installing Batteries in the Remote Control

1. Slide the back cover to open the battery compartment of the remote control.
2. Insert two AAA size batteries. Make sure to match the (+) and (-) ends of the batteries with the (+) and (-) ends indicated in the battery compartment.
3. Close the battery compartment with the cover.

### NOTE

- Dispose of your batteries in a designated disposal area.
- Do not mix battery types or combine used batteries with new ones.
- Remove depleted batteries immediately to prevent battery acid from leaking into the battery compartment.
- If you do not intend to use the remote control for a long time, remove the batteries.
- Leaving a battery in an extremely high temperature surrounding environment that can result in an explosion or the leakage of flammable liquid or gas.
- Battery chemicals can cause a rash. If the batteries leak, clean the battery compartment with a cloth. If chemicals touch your skin, wash immediately.
- Risk of fire or explosion if the battery is replaced by an incorrect type.
- Disposal of a battery into fire or a hot oven, or mechanically crushing or cutting of a battery, that can result in an explosion.
- A battery subjected to extremely low air pressure that may result in an explosion or the leakage of flammable liquid or gas.

## ► Remote Control Operation Range

1. The remote control can work at a distance of up to 8 metres in front of the TV set.
2. The remote control angle: taking the remote sensor as an apex, 6 metres away, its controlled horizontal angle is within  $\pm 30^\circ$ , while the vertical angle is within  $\pm 15^\circ$ .
3. The operating distance may vary depending on the brightness of the room.

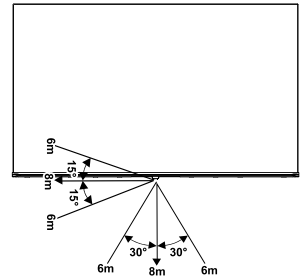

## Disposal of this unit

Product should not be damaged, dismantled or thrown in municipal waste. It should be packed and handed over to authorised re-cycler.

# Specifications

Features, appearance and specifications are subject to change without notice.

Item		32"	40"
Dimension (W × H × D)	Without Stand	28.5 × 16.8 × 3.1 inches (725 × 426 × 78 mm)	35.4 × 20.1 × 3.1 inches (898 × 511 × 78 mm)
	With Stand	28.5 × 17.9 × 7.1 inches (725 × 455 × 180 mm)	35.4 × 21.2 × 7.1 inches (898 × 539 × 179 mm)
Weight	Without Stand	7.5 lbs (3.4 kg)	10.6 lbs (4.8 kg)
	With Stand	7.7 lbs (3.5 kg)	10.8 lbs (4.9 kg)
Active Screen Size (Diagonal)		80 cm	100 cm
Audio power		7 W + 7 W	7 W + 7 W
Operating mode power density		0.020 Watts/cm <sup>2</sup>	0.017 Watts/cm <sup>2</sup>
Item		50"	
Dimension (W × H × D)	Without Stand	43.7 × 25.8 × 2.8 inches (1111 × 655 × 72 mm)	
	With Stand	43.7 × 27.1 × 9.7 inches (1111 × 688 × 247 mm)	
Weight	Without Stand	16.3 lbs (7.4 kg)	
	With Stand	16.5 lbs (7.5 kg)	
Active Screen Size (Diagonal)		126 cm	
Audio power		8 W + 8 W	
Operating mode power density		0.012 Watts/cm <sup>2</sup>	
Network standby power consumption		≤ 2.0 W	
Power consumption in standby mode		0.5 W	
Power consumption		Please refer to the rating label.	
Power supply		Please refer to the rating label.	
Screen resolution		1920 × 1080	
Receiving systems	Analog	PAL-D/K, B/G, I, SECAM-D/K, B/G	
	Digital	DVB-T/T2, DVB-C, DVB-S/S2	
Wireless LAN Module specifications	Frequency Range	2.4-2.4835GHz	
	Output Power (Max.)	2.4-2.4835GHz 17dBm	
	Standards	IEEE 802.11b/g/n	
Environmental conditions		Temperature: 41°F - 95°F (5°C - 35°C) Humidity: 20% - 80% RH Atmospheric pressure: 86 kPa - 106 kPa	
HDMI Input		RGB / 60Hz (640×480, 800×600, 1024×768) YUV / 60Hz (480i, 480p, 720p, 1080i, 1080p) YUV / 50Hz (720p, 1080i, 1080p)	

## Other Information

---

### Recycling/Licenses

#### WEEE (Waste Electronic Electric Equipment)

##### European Directive 2012/19/EU



This symbol on the product or on its packaging indicates that this product must not be disposed of with your household waste. Instead, it is your responsibility to dispose of your waste equipment by handing it over to a designated collection point for the recycling of waste electrical and electronic equipment. The separate collection and recycling of your waste equipment at the time of disposal will help to conserve natural resources and ensure that it is recycled in a manner that protects human health and the environment. For more information about where you can drop off your waste equipment for recycling, please contact your local city office, your household waste disposal service or the shop where you purchased the product.

### Batteries



In accordance with the Battery Directive, used batteries should not be disposed of in the domestic waste. Dispose your batteries in the collection containers specific for this purpose in retail stores.

### ROHS (Restriction of Hazardous Substance)

##### European Directive 2011/65/EU



This European directive limits the use of dangerous and hazardous substances which are difficult to recycle.

This allows recycling easily the EEE and contributes to the safeguard of the environment. Substances included in this product match to the RoHS directive.



The terms HDMI, HDMI High-Definition Multimedia Interface, HDMI Trade dress and the HDMI Logos are trademarks or registered trademarks of HDMI Licensing Administrator, Inc.

32"/40"



FOR DTS PATENTS, SEE [HTTP://XPERI.COM/DTS-PATENTS/](http://XPERI.COM/DTS-PATENTS/). MANUFACTURED UNDER LICENSE FROM DTS, INC. AND ITS AFFILIATES. DTS, DTS:X, AND THE DTS:X LOGO ARE REGISTERED TRADEMARKS OR TRADEMARKS OF DTS, INC. AND ITS AFFILIATES IN THE UNITED STATES AND/OR OTHER COUNTRIES. © DTS, INC. AND ITS AFFILIATES. ALL RIGHTS RESERVED.



Dolby, Dolby Atmos, and the double-D symbol are registered trademarks of Dolby Laboratories Licensing Corporation. Manufactured under license from Dolby Laboratories. Confidential unpublished works. Copyright © 2012-2024 Dolby Laboratories. All rights reserved.

50"



Manufactured under license from DTS, Inc. and/or its affiliates. For patents, see <https://xperi.com/dts-patents/>. DTS, the DTS logo, DTS:X, and the DTS:X logo are trademarks or registered trademarks of DTS, Inc. and/or its affiliates in the U.S. and/or other countries. © DTS, Inc. and/or its affiliates. All rights reserved.

## EPREL Registration Information

### EPREL-Registrierungsdaten

### Información del registro EPREL

### Informazioni di registrazione EPREL

### Informação de Registo EPREL

### Informations sur l'enregistrement EPREL

### EPREL-registratiegegevens

32A5S (2523437)	40A5S (2526487)	50A5S (2616464)
32A57S (2523464)	40A57S (2526492)	50A57S (2616465)
32A58S (2523466)	40A58S (2526498)	50A58S (2616466)
32A59S (2523467)	40A59S (2526500)	50A59S (2616484)
32A5DS (2523469)	40A5DS (2526503)	50A5DS (2616488)
32E5ST (2523471)	40E5ST (2526507)	50E5ST (2616489)
32E51ST (2523472)	40E51ST (2526508)	50E51ST (2616490)
32E52ST (2523474)	40E52ST (2526510)	50E52ST (2616492)
32E53ST (2523476)	40E53ST (2526512)	50E53ST (2616493)
32A5STUK (2523480)	40A5STUK (2526514)	50A5STUK (2616495)
32A57STUK (2523482)	40A57STUK (2526516)	50A57STUK (2616496)
32A58STUK (2523484)	40A58STUK (2526517)	50A58STUK (2616497)
32A59STUK (2523485)	40A59STUK (2526518)	50A59STUK (2616498)
32E5STUK (2523486)	40E5STUK (2526519)	50E5STUK (2616500)
32E51STUK (2523489)	40E51STUK (2526528)	50E51STUK (2616501)