

MultiDock

CHARGING AND STORAGE FOR MULTIPLE iOS DEVICES

User Manual

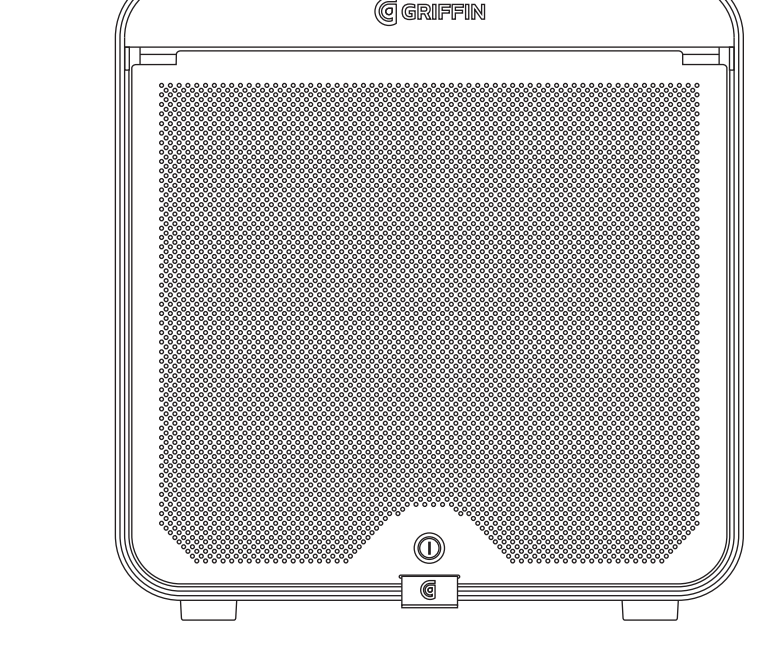

LET'S GET TO WORK

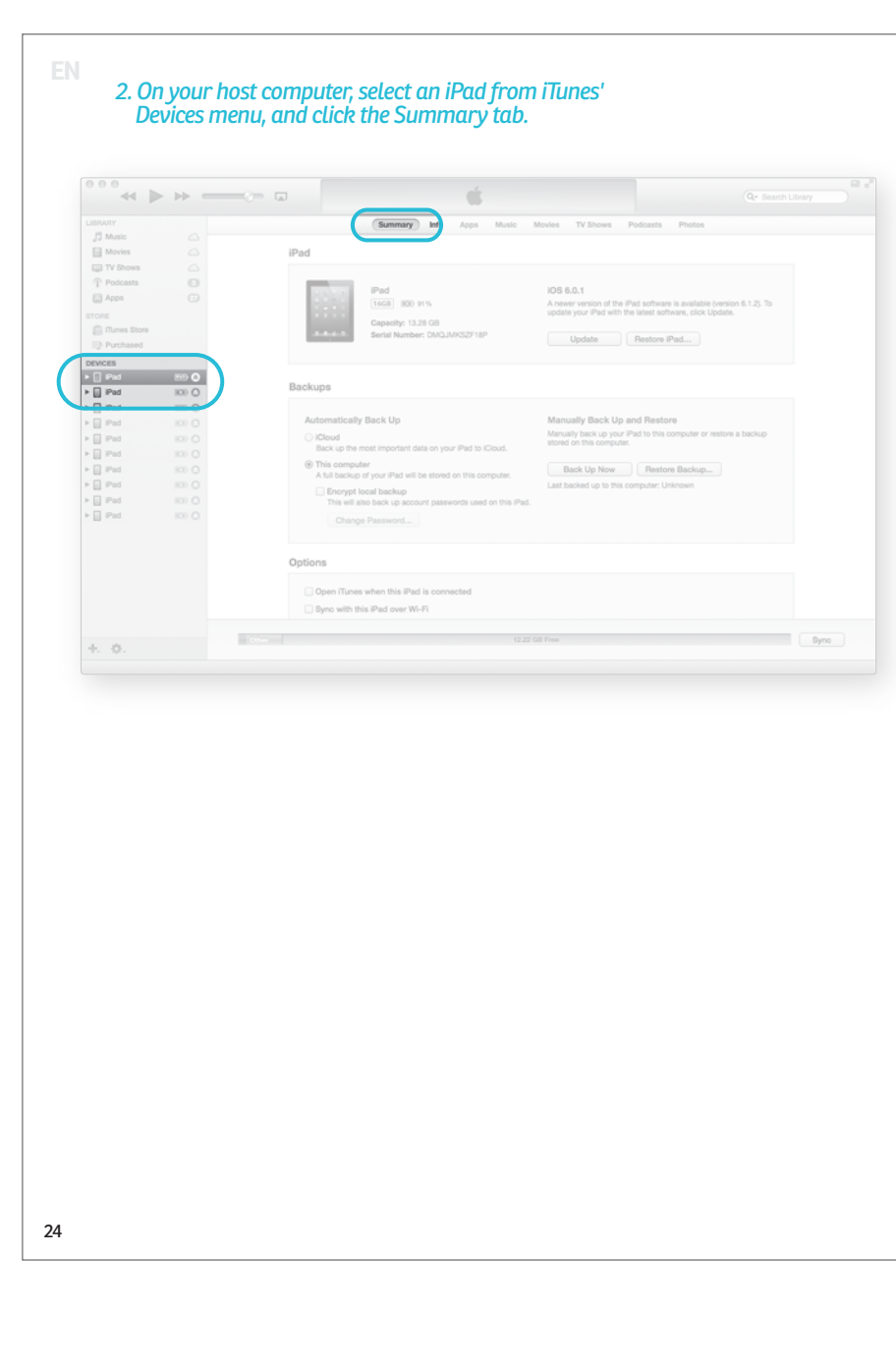

2. On your host computer, click on **My iPad From iTunes** > **Devices** menu, and select the **Summary** tab.

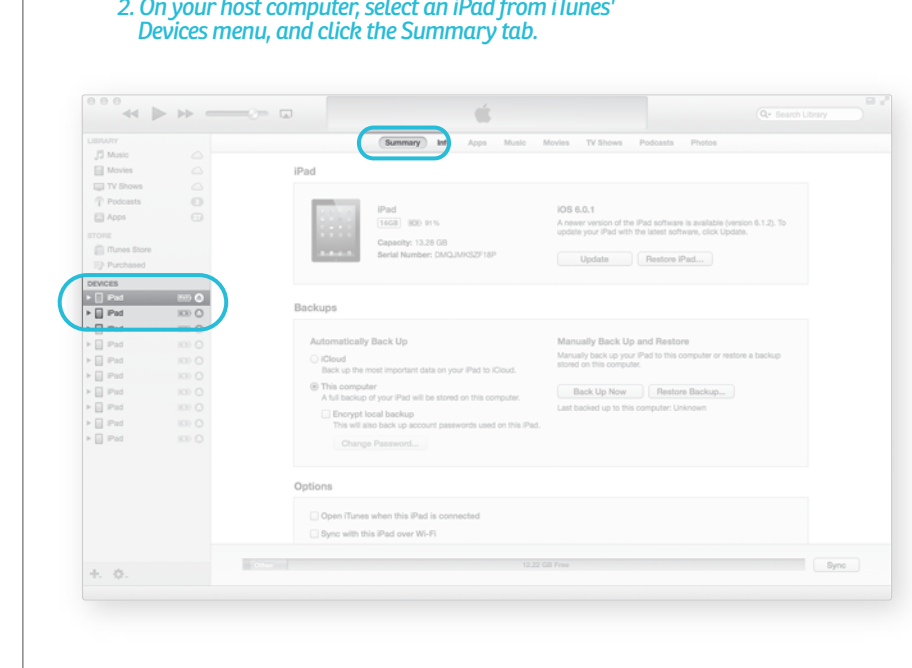

3. Under the **Summary** tab, set the desired syncing behavior:

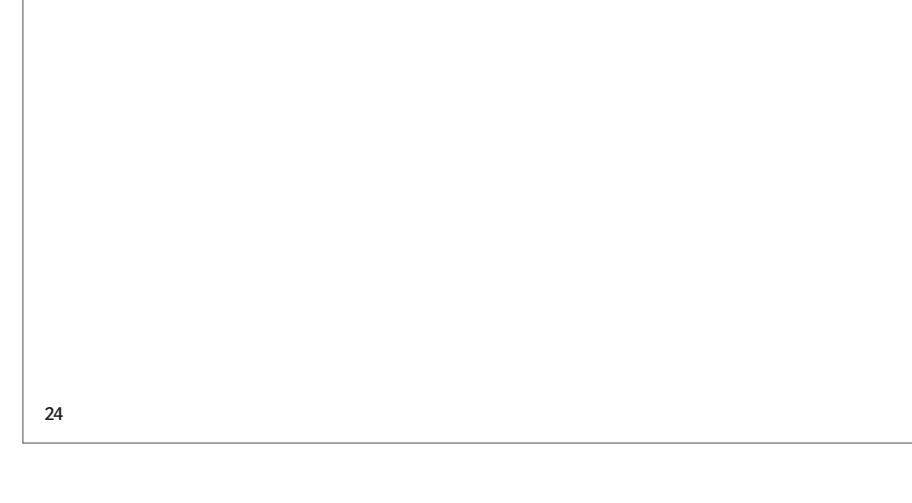

2. Sur l'ordinateur, cliquez sur **My iPad From iTunes** > **Devices** menu, et sélectionnez l'onglet **Summary**.



3. Sous l'onglet **Summary**, réglez le comportement de synchronisation souhaité :

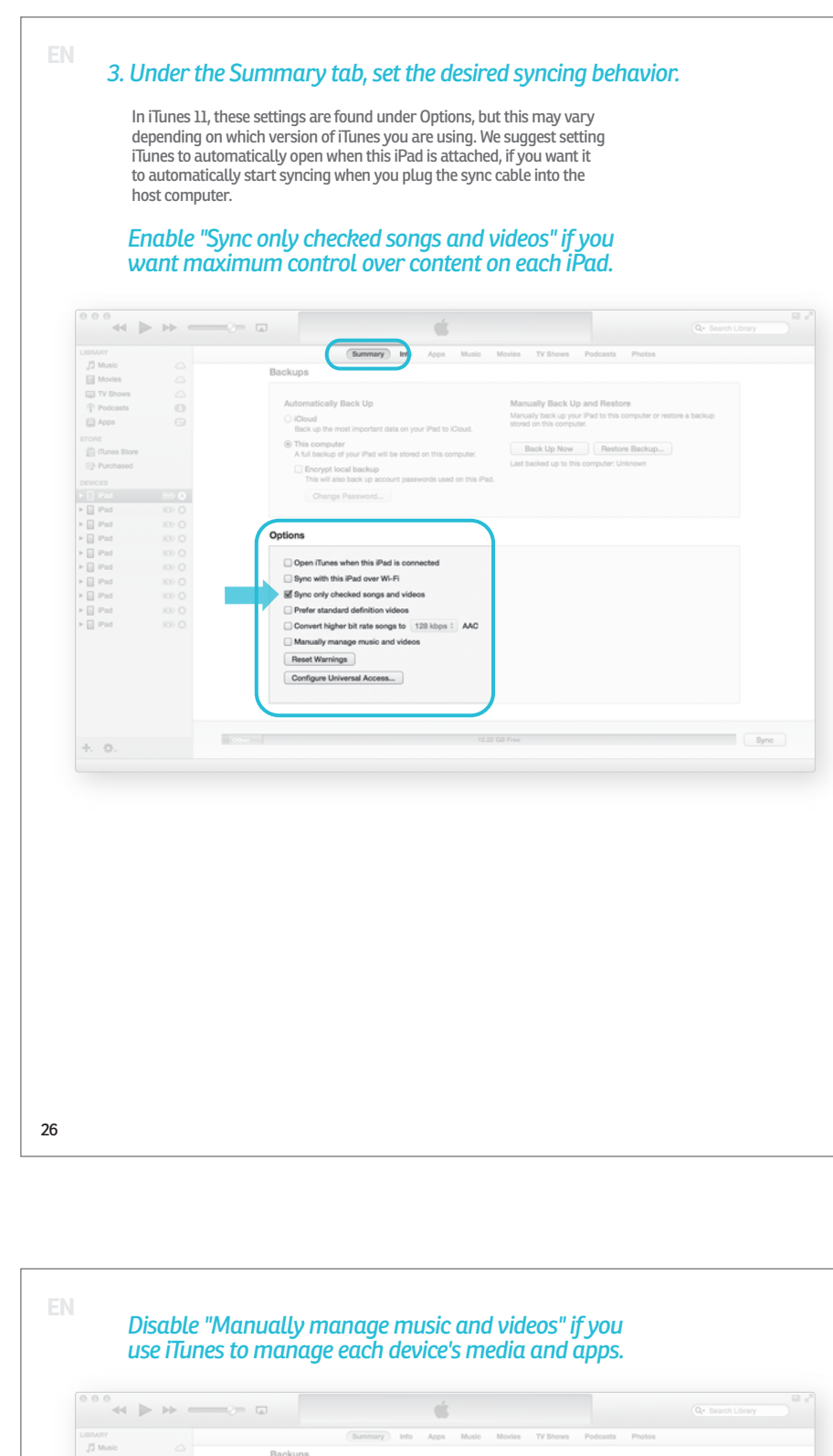
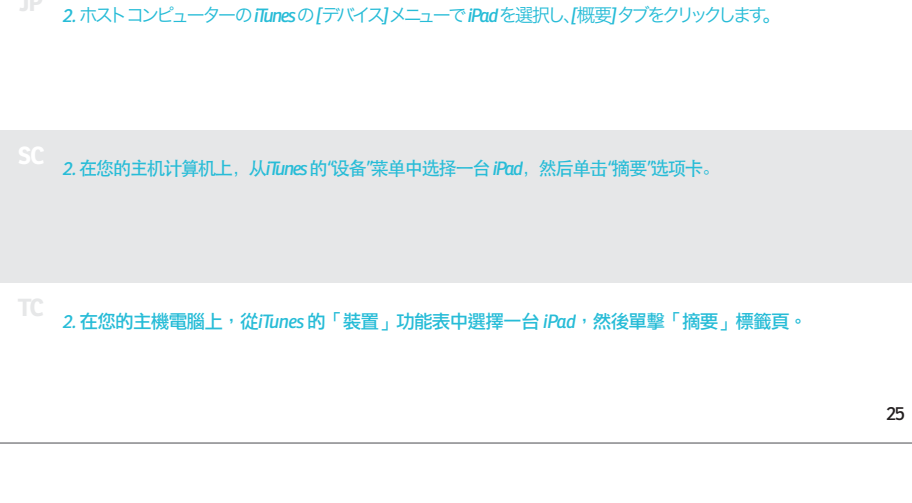

3. Under the **Summary** tab, set the desired syncing behavior:

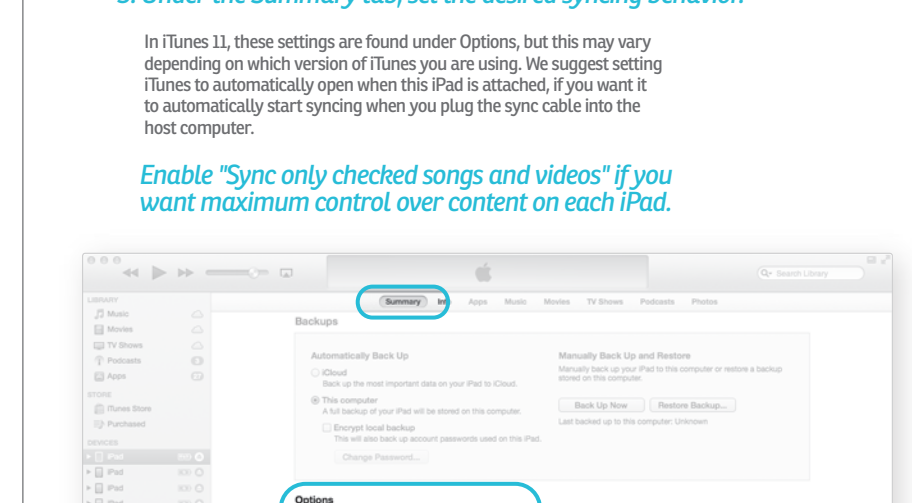

Enable "Sync only checked songs and videos" if you want maximum control over content on each iPad.

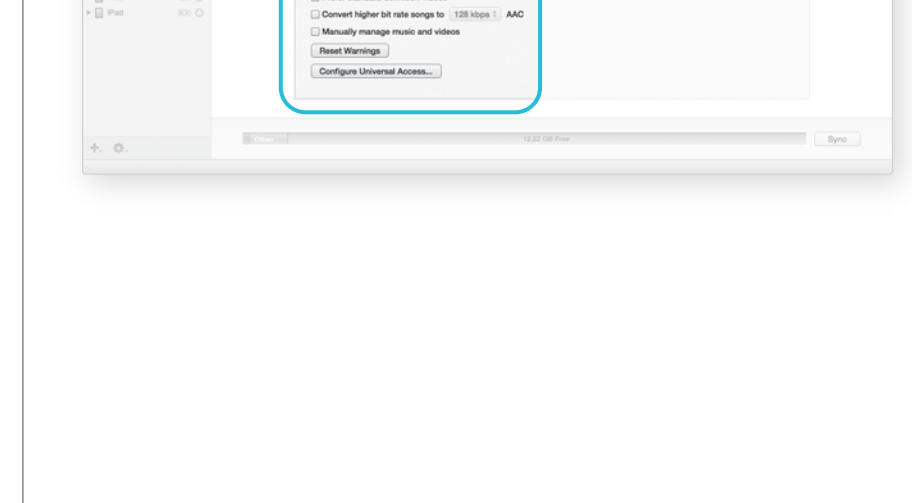

3. Unter dem **Summary**-Tab, setzen Sie das gewünschte Synchronisierungsverhalten:

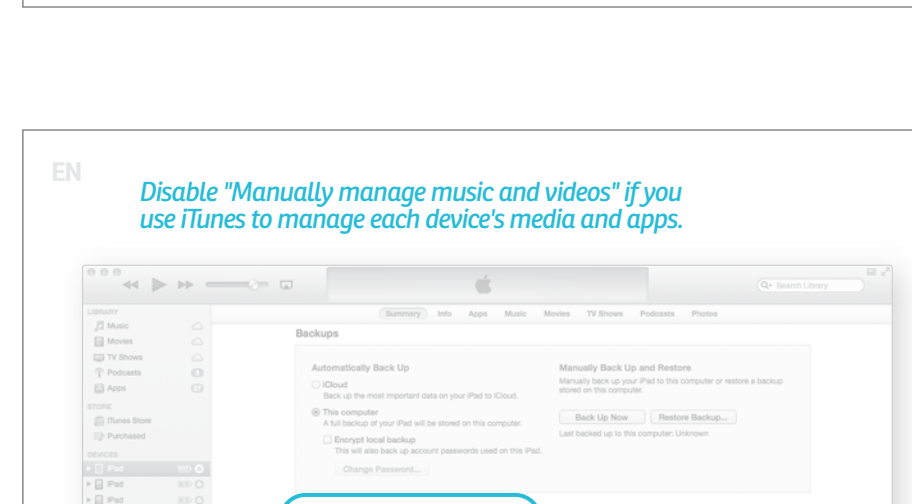

Enable "Sync only checked songs and videos" if you want maximum control over content on each iPad.

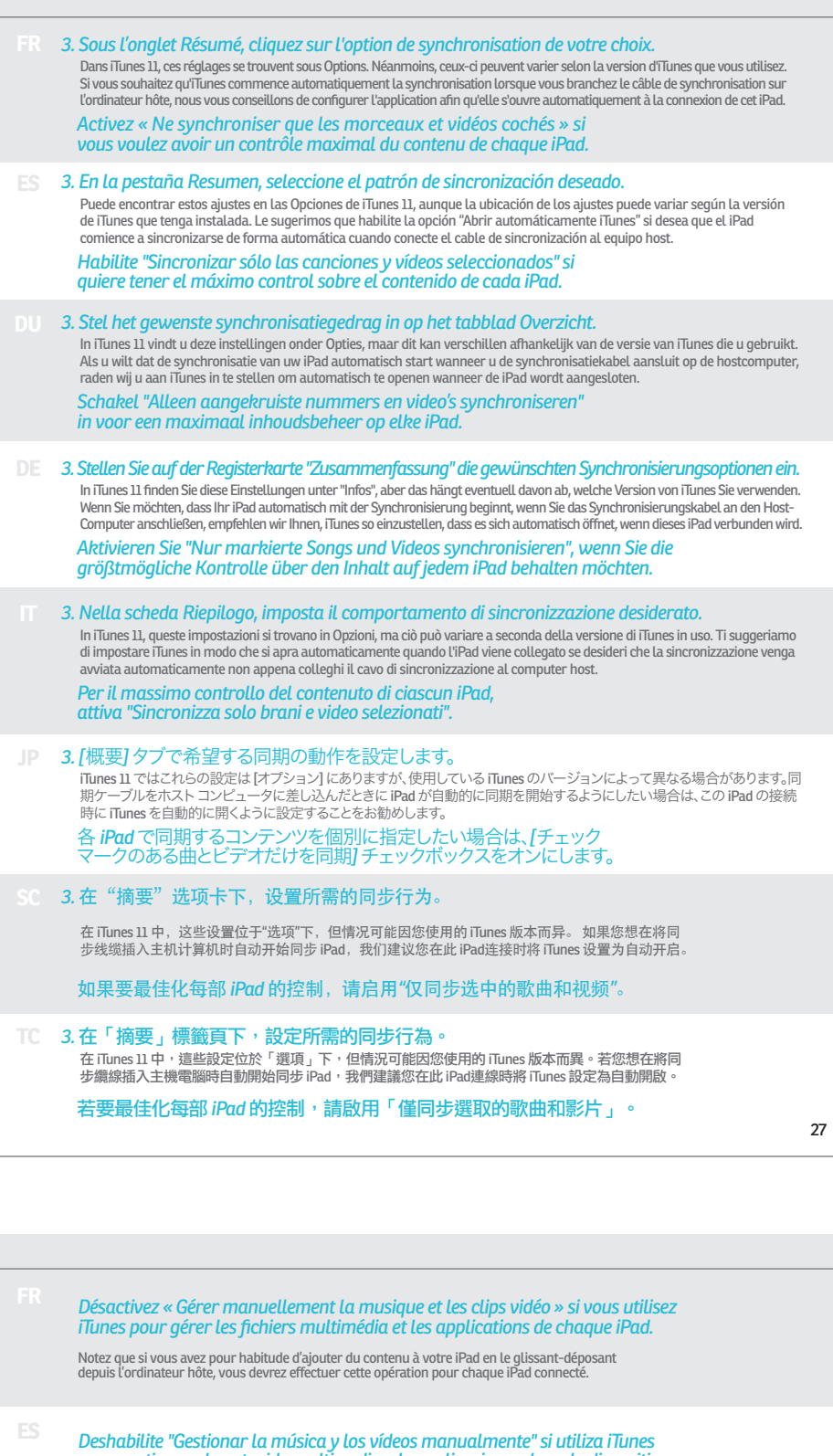

3. Sous l'onglet **Summary**, réglez le comportement de synchronisation souhaité :

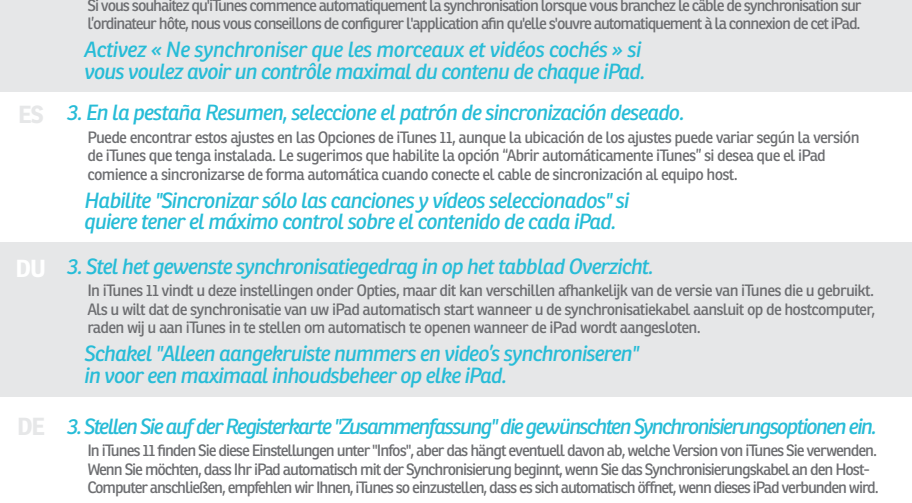

Enable "Sync only checked songs and videos" if you want maximum control over content on each iPad.

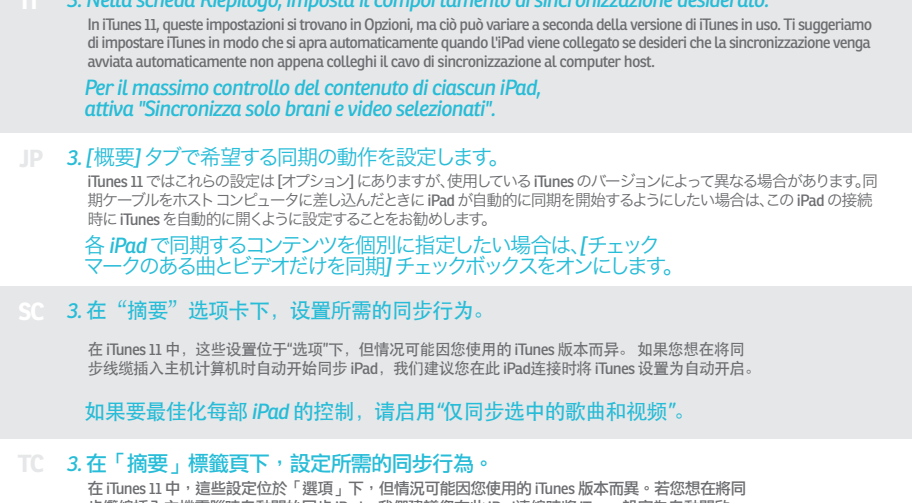

3. Unter dem **Summary**-Tab, setzen Sie das gewünschte Synchronisierungsverhalten:



Enable "Sync only checked songs and videos" if you want maximum control over content on each iPad.

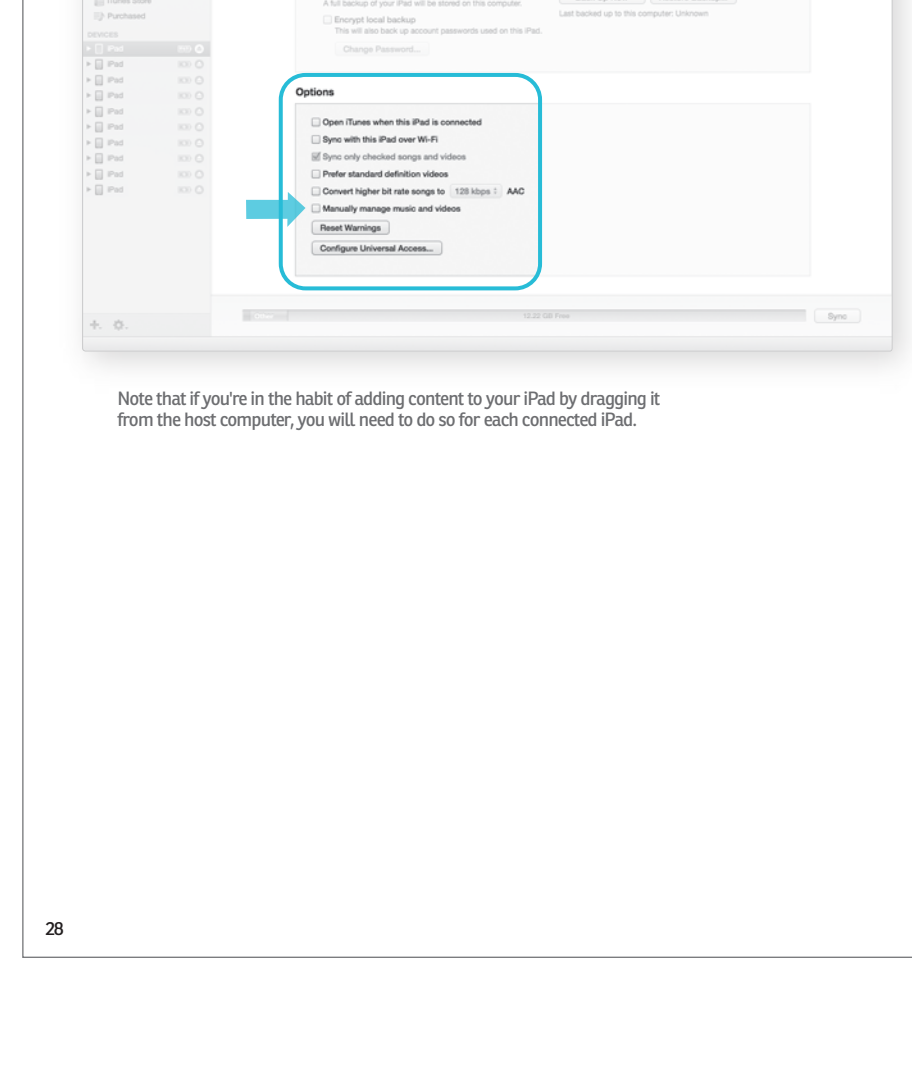

4. In the remaining tabs, select the media, playlists, and apps you want to sync to that iPad.

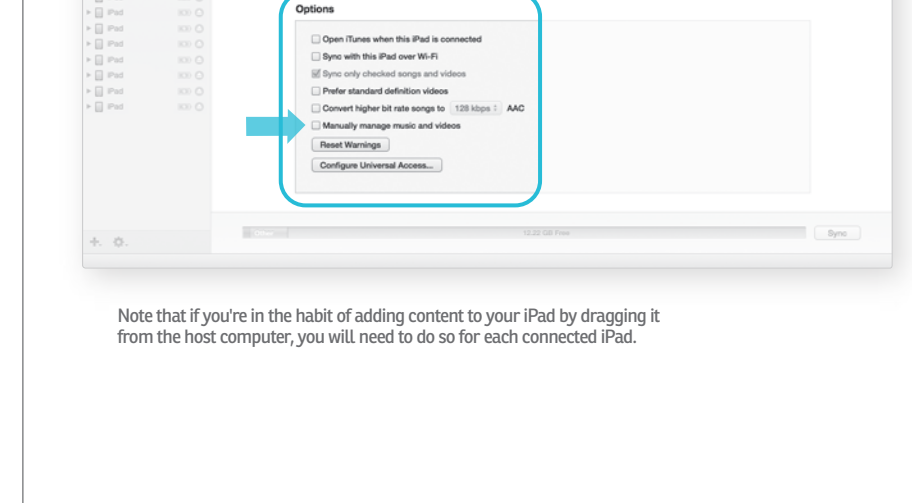

4. Dans les onglets restants, sélectionnez les médias, playlists, et apps que vous voulez synchroniser sur cet iPad.

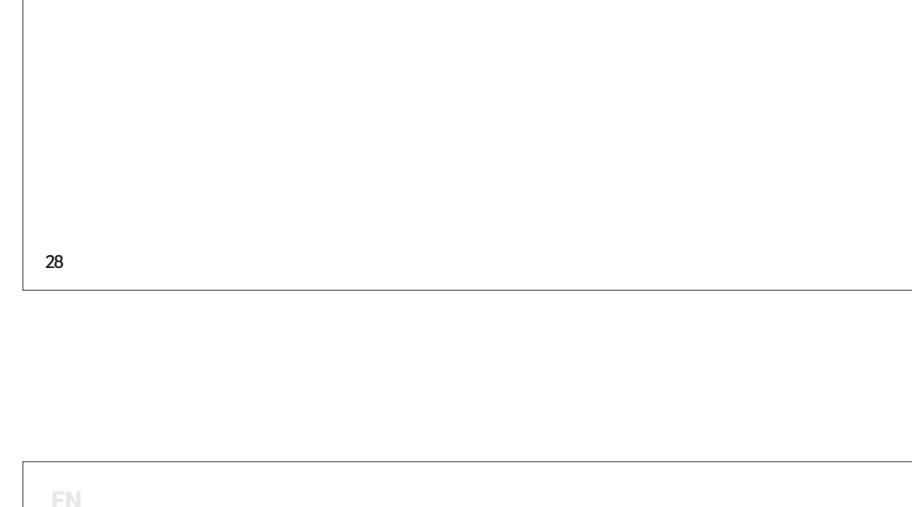

4. In the remaining tabs, select the media, playlists, and apps you want to sync to that iPad.



4. Dans les onglets restants, sélectionnez les médias, playlists, et apps que vous voulez synchroniser sur cet iPad.

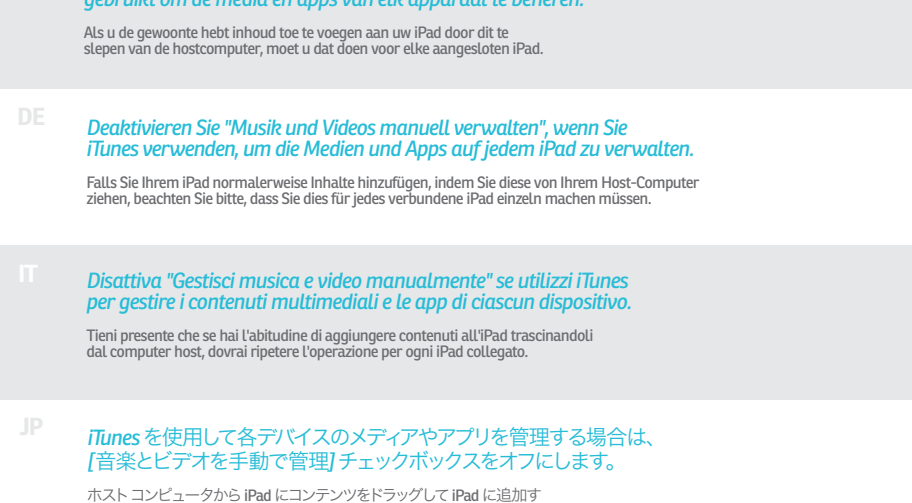

4. In the remaining tabs, select the media, playlists, and apps you want to sync to that iPad.



4. In the remaining tabs, select the media, playlists, and apps you want to sync to that iPad.

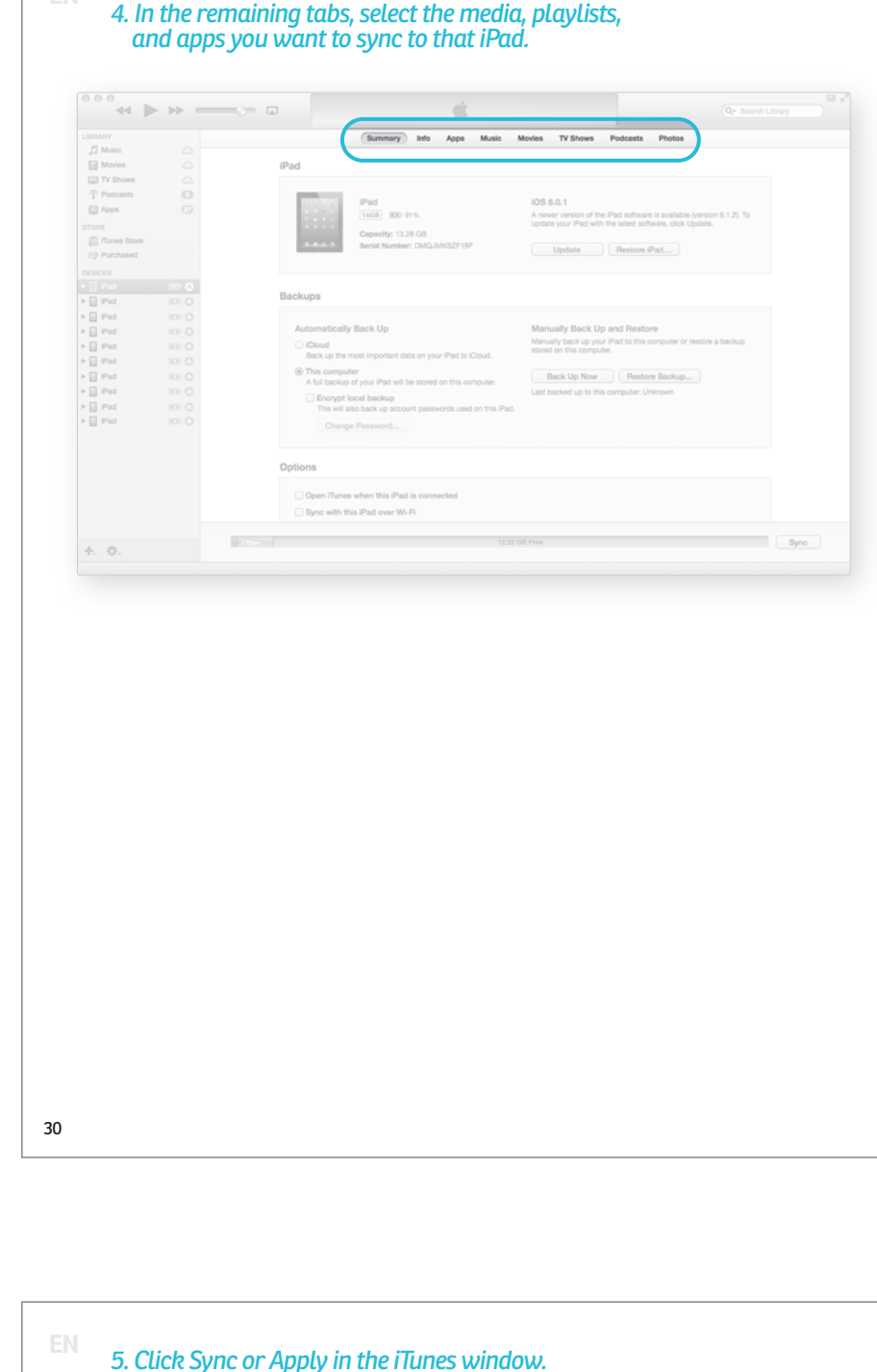

4. In the remaining tabs, select the media, playlists, and apps you want to sync to that iPad.

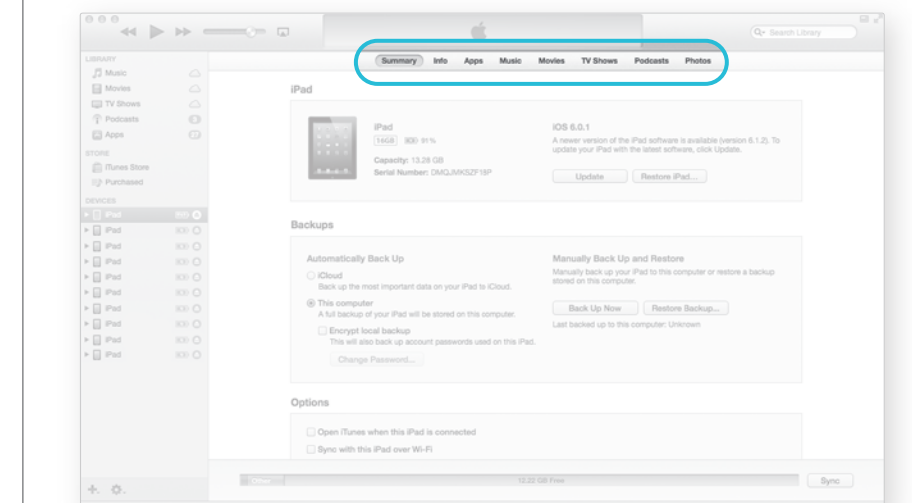

4. In the remaining tabs, select the media, playlists, and apps you want to sync to that iPad.



4. In the remaining tabs, select the media, playlists, and apps you want to sync to that iPad.

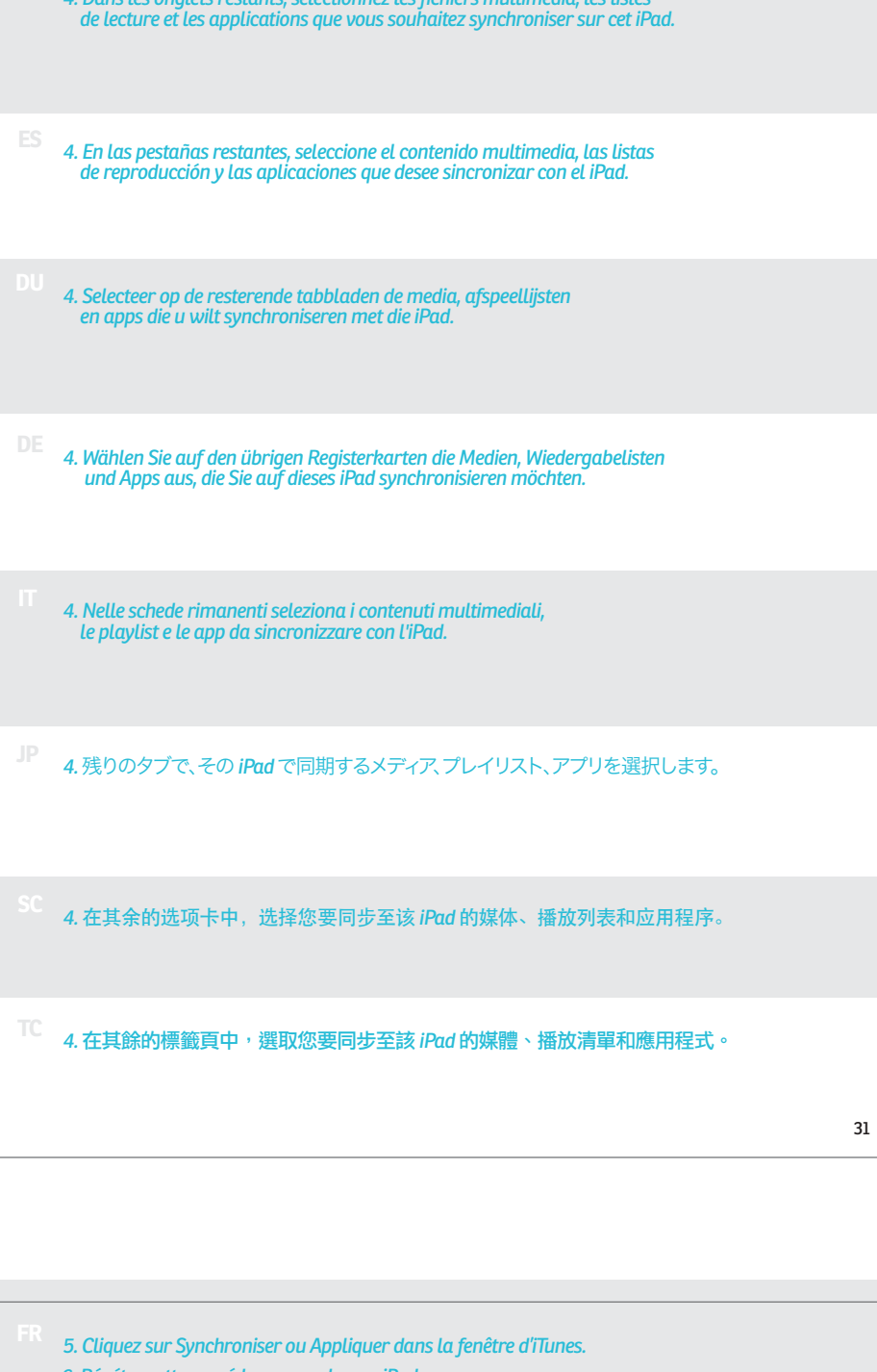

4. Dans les onglets restants, sélectionnez les médias, playlists, et apps que vous voulez synchroniser sur cet iPad.



4. In the remaining tabs, select the media, playlists, and apps you want to sync to that iPad.

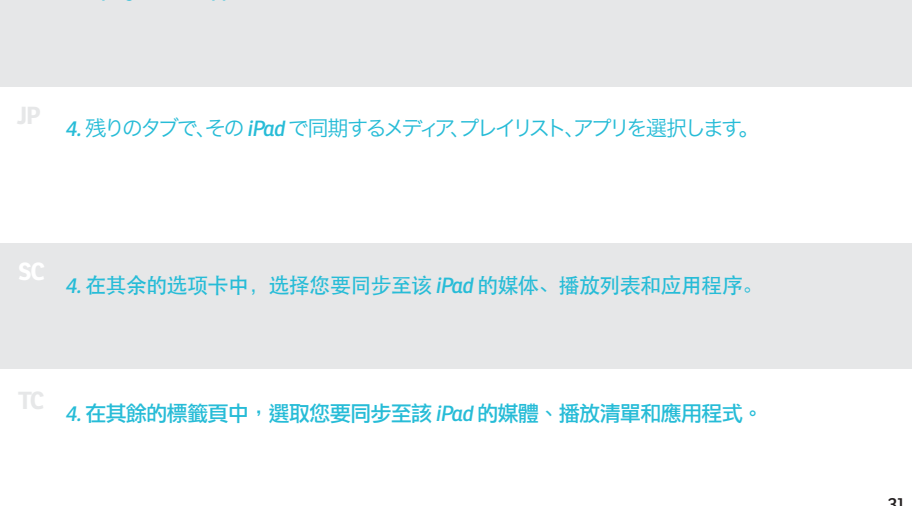

4. In the remaining tabs, select the media, playlists, and apps you want to sync to that iPad.

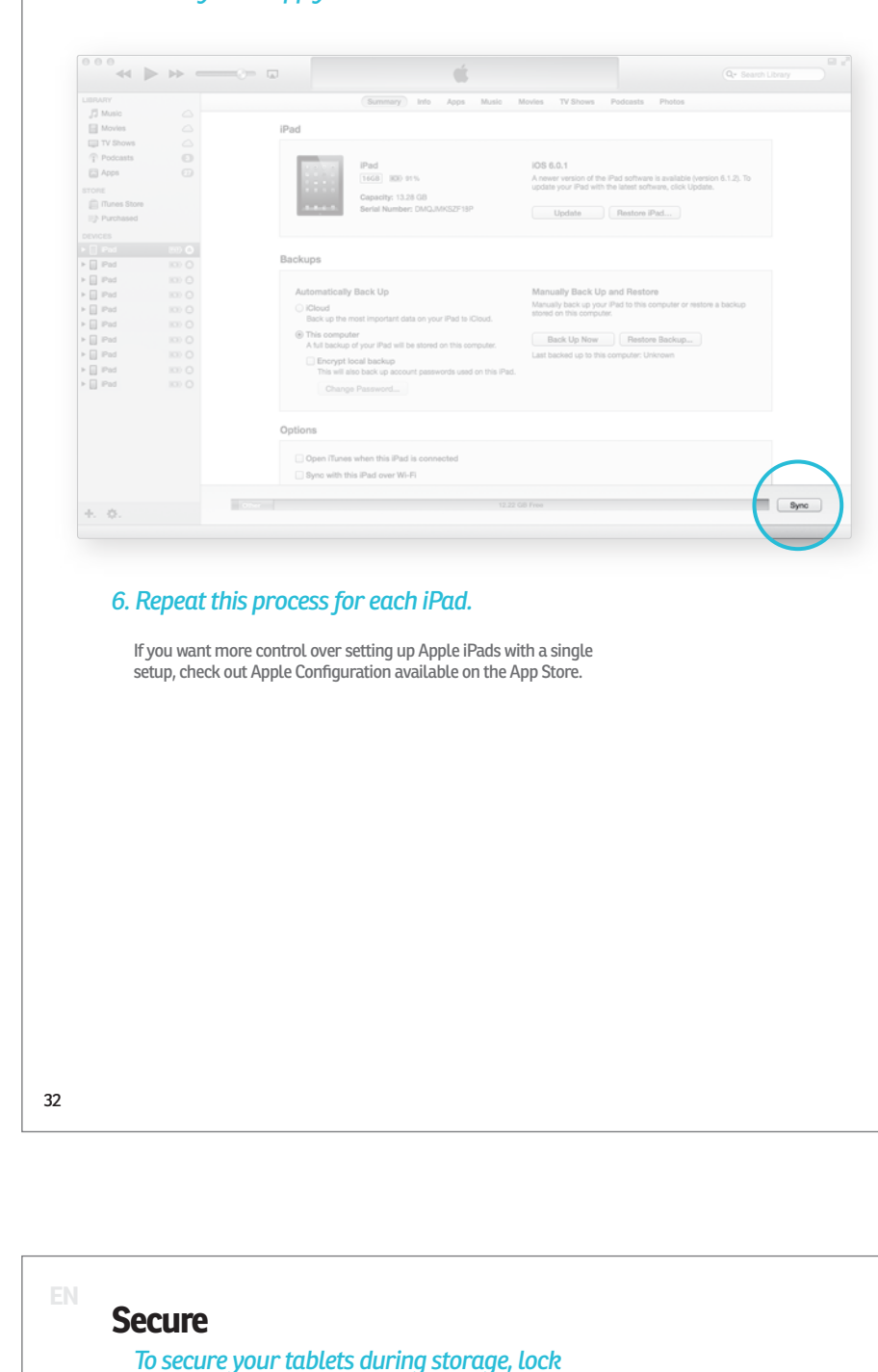

5. Click **Sync** or **Apply** in the iTunes window.

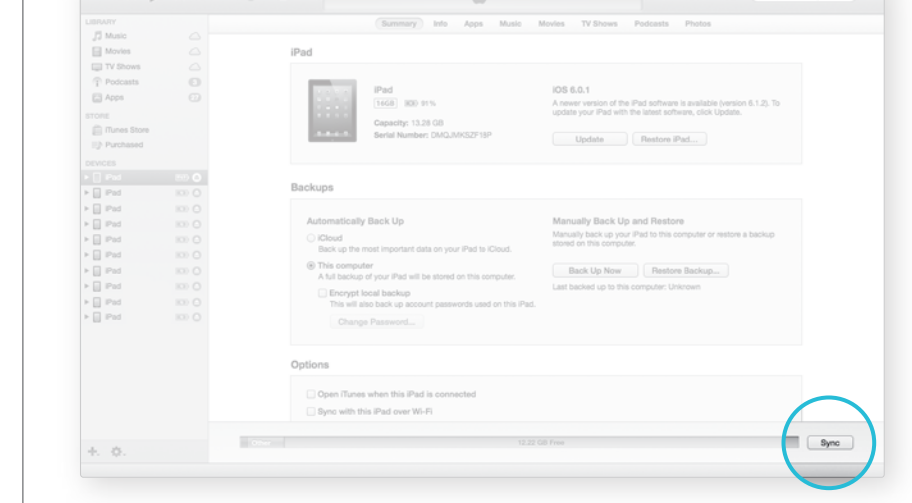

5. Cliquez sur **Synchroniser** ou **Appliquer** dans la fenêtre iTunes.

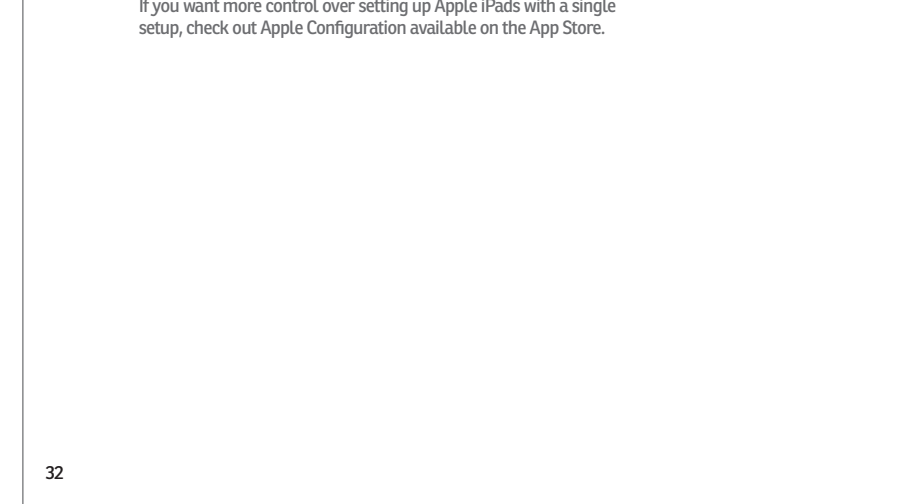

5. Click **Sync** or **Apply** in the iTunes window.

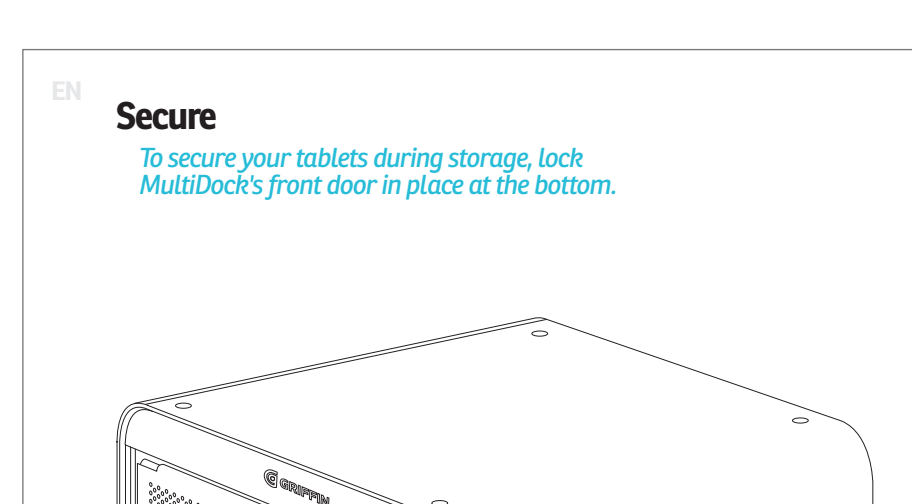

5. Click **Sync** or **Apply** in the iTunes window.



5. Cliquez sur **Synchroniser** ou **Appliquer** dans la fenêtre iTunes.



5. Click **Sync** or **Apply** in the iTunes window.



5. Click **Sync** or **Apply** in the iTunes window.

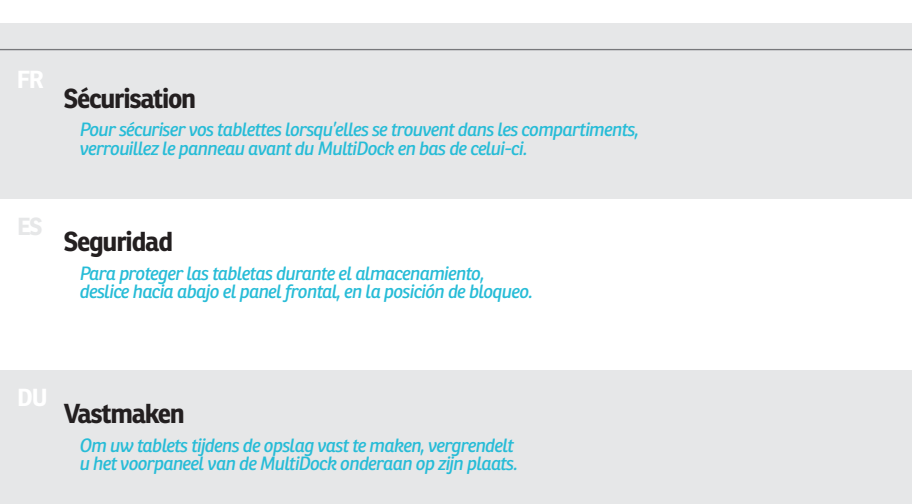

5. Click **Sync** or **Apply** in the iTunes window.

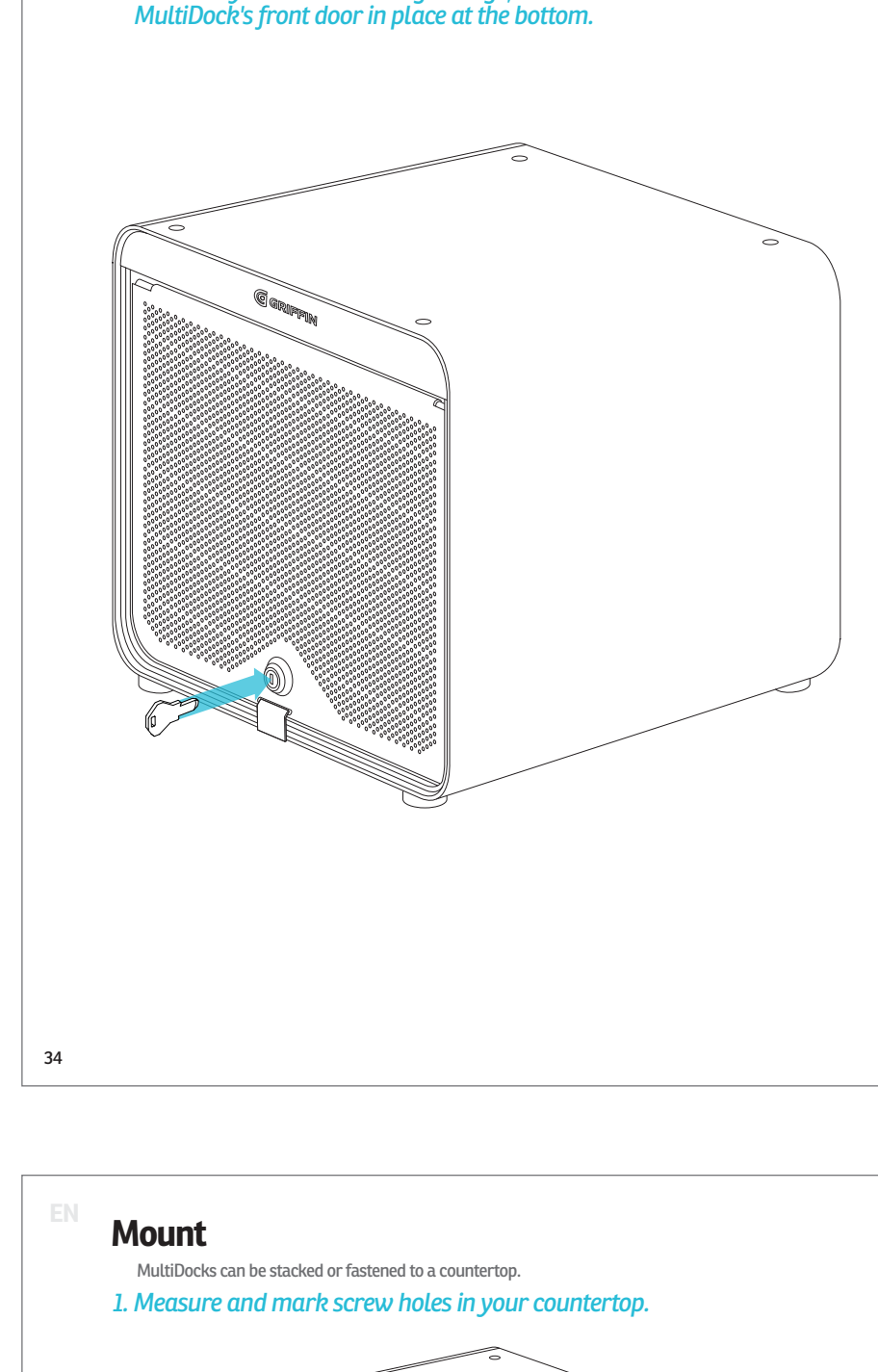

6. Repeat this process for each iPad.

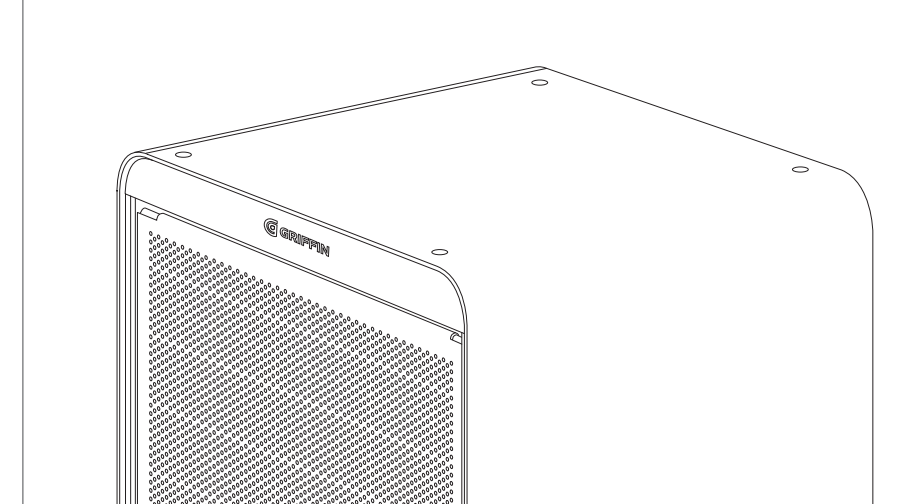

6. Répétez ce processus pour chaque iPad.

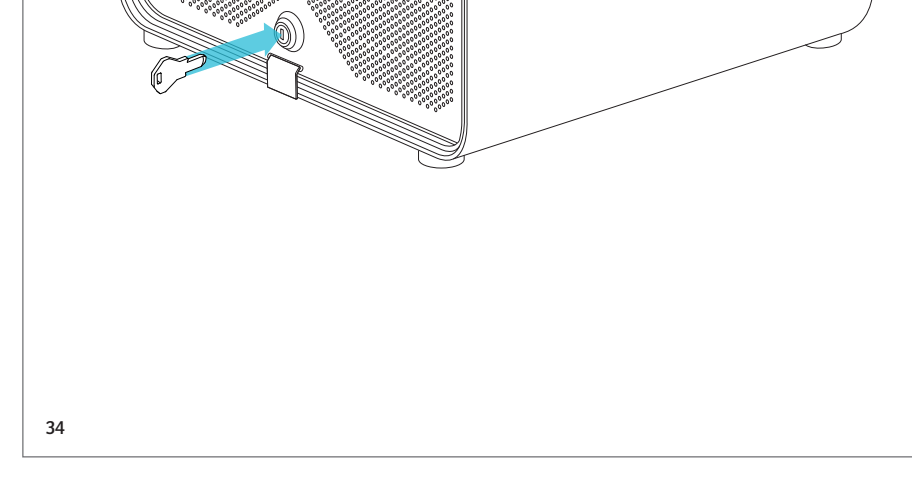

6. Repeat this process for each iPad.

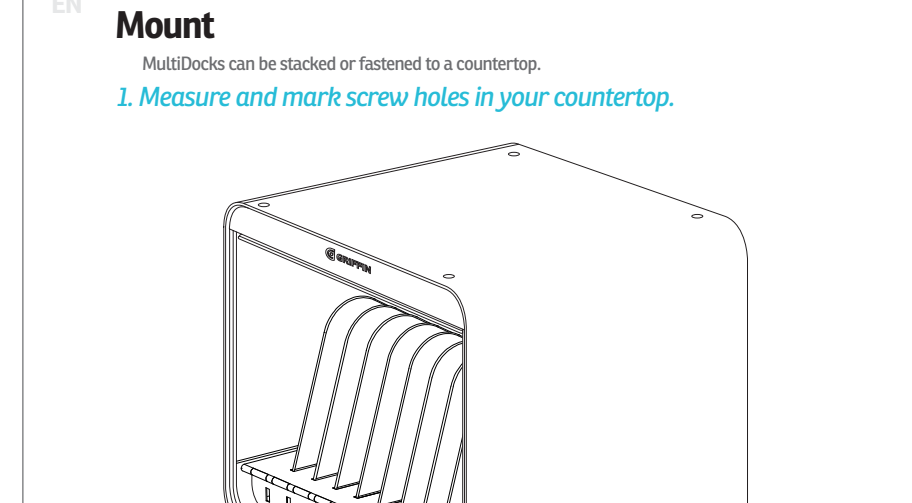

6. Repeat this process for each iPad.



6. Répétez ce processus pour chaque iPad.

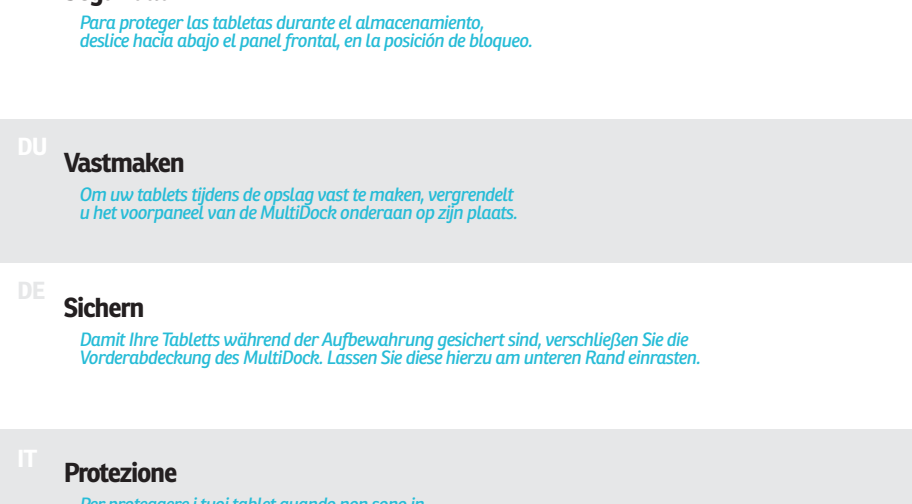

6. Répétez ce processus pour chaque iPad.

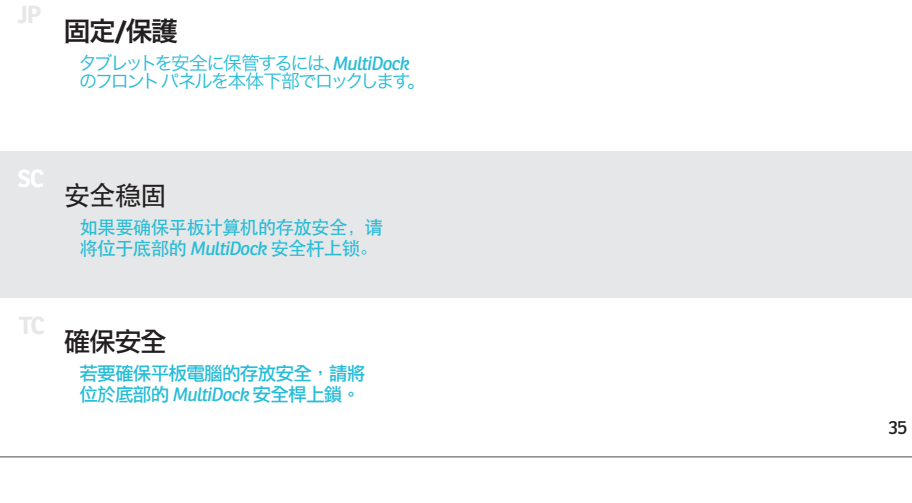

6. Répétez ce processus pour chaque iPad.



6. Répétez ce processus pour chaque iPad.

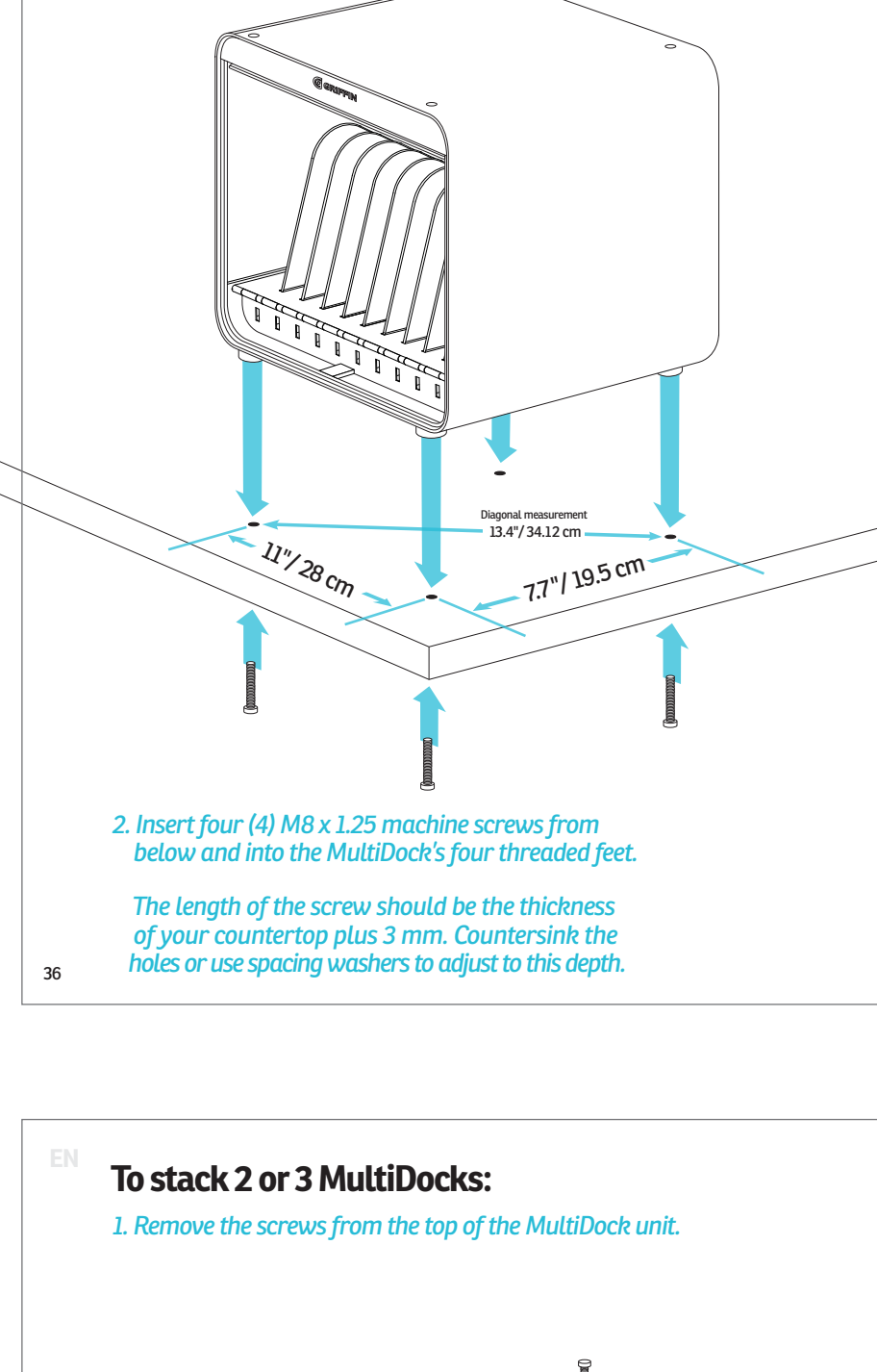

7. Place the power cord into MultiDock's power supply and connect the other end of the power cord to your outlet.

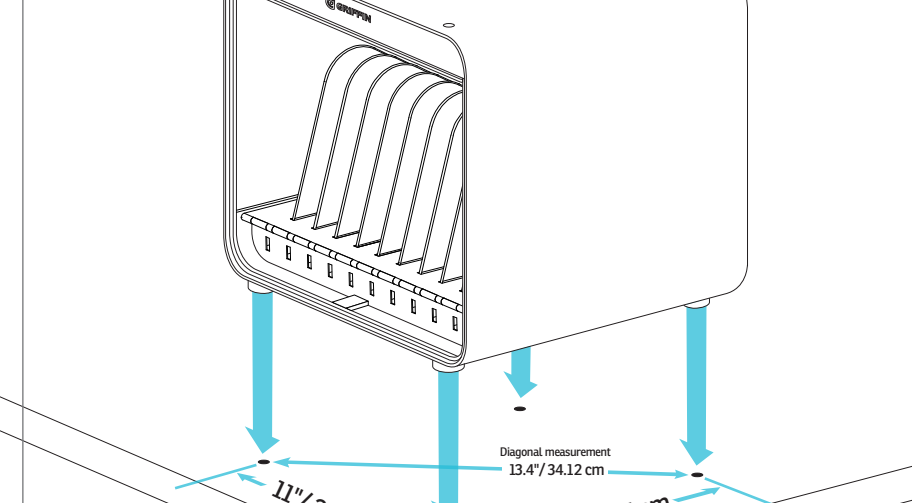

7. Branchez un câble d'alimentation à la prise de MultiDock et branchez l'autre extrémité sur une prise secteur.

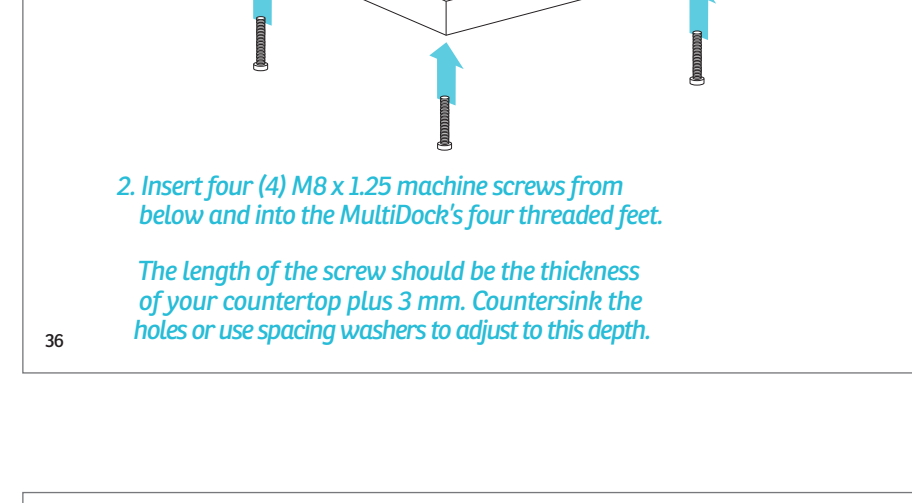

7. Place the power cord into MultiDock's power supply and connect the other end of the power cord to your outlet.

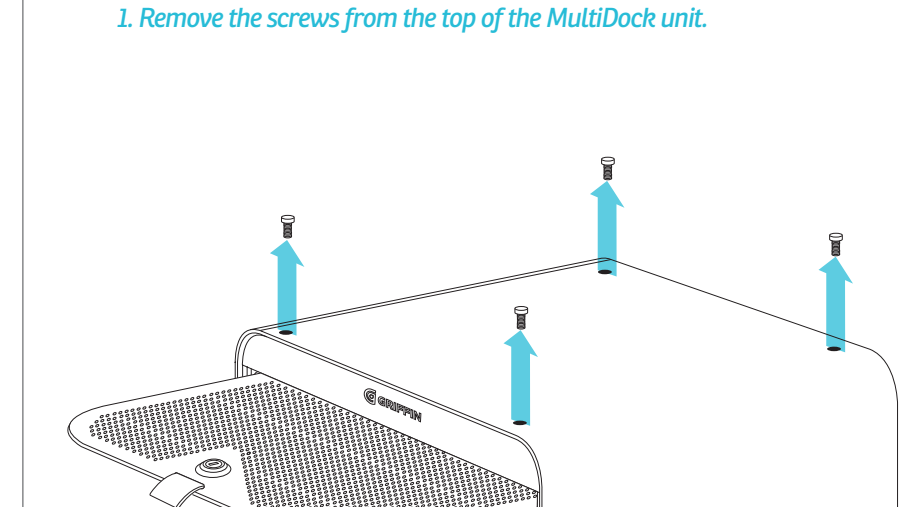

7. Place the power cord into MultiDock's power supply and connect the other end of the power cord to your outlet.



7. Branchez un câble d'alimentation à la prise de MultiDock et branchez l'autre extrémité sur une prise secteur.



7. Branchez un câble d'alimentation à la prise de MultiDock et branchez l'autre extrémité sur une prise secteur.



7. Branchez un câble d'alimentation à la prise de MultiDock et branchez l'autre extrémité sur une prise secteur.

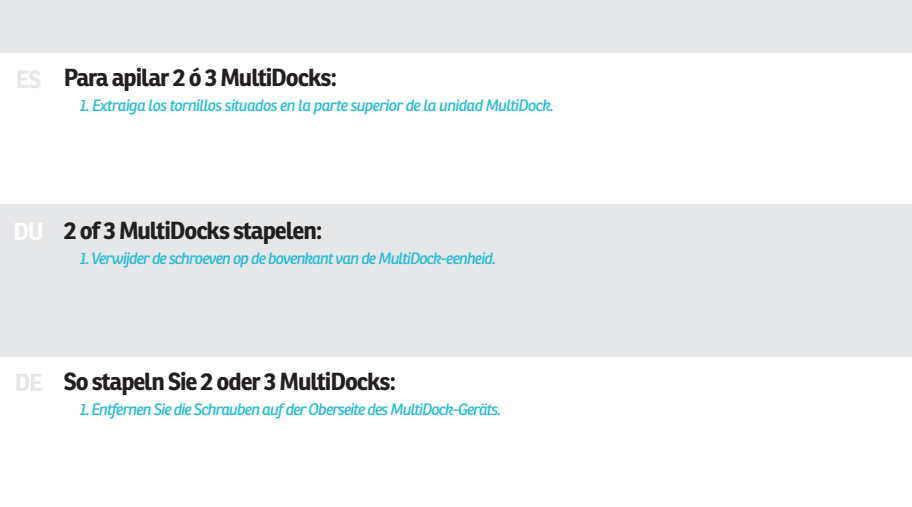

7. Branchez un câble d'alimentation à la prise de MultiDock et branchez l'autre extrémité sur une prise secteur.

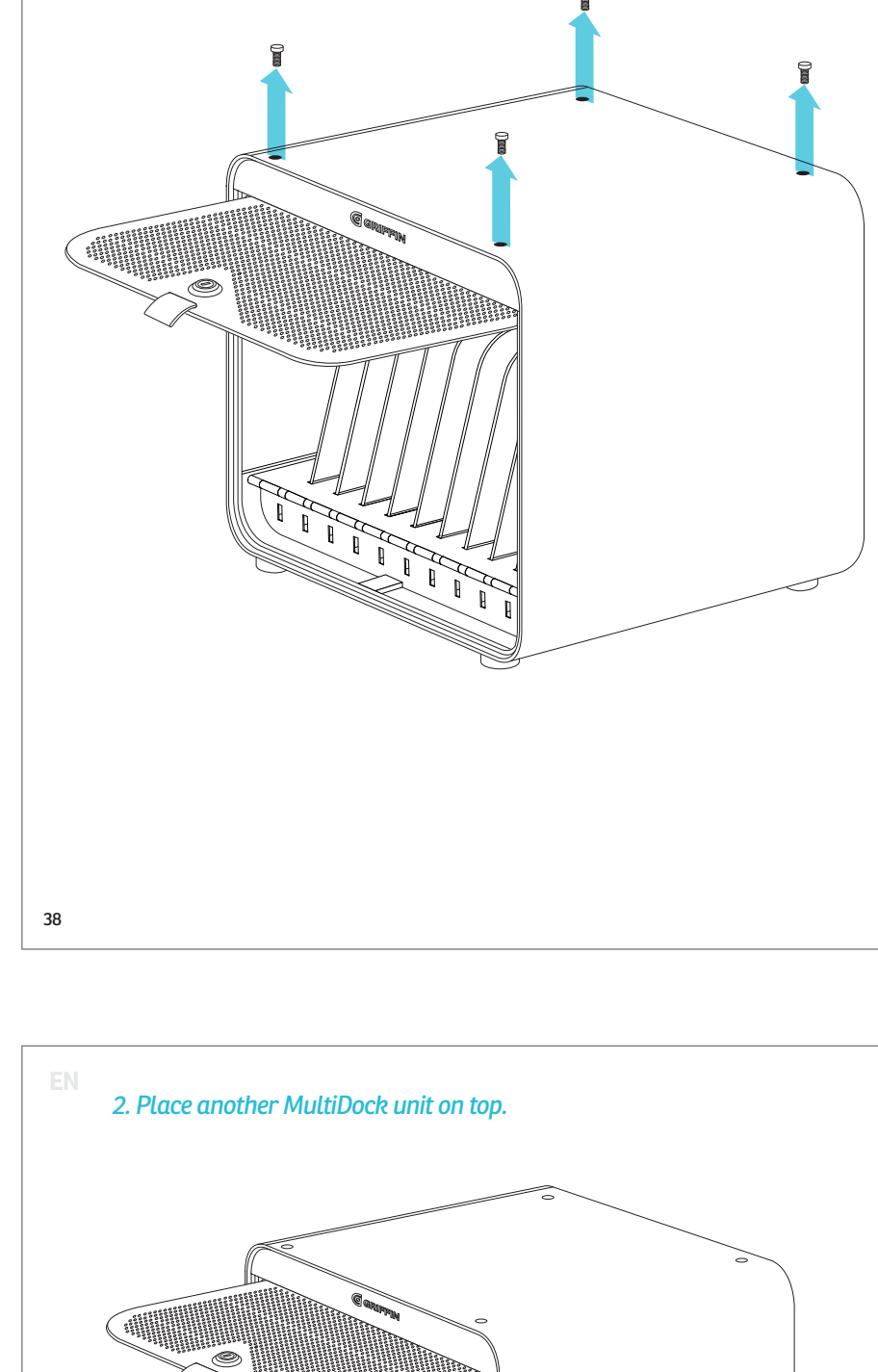

8. Plug a charging cable into each dock, and the USB end of each charging cable into MultiDock.

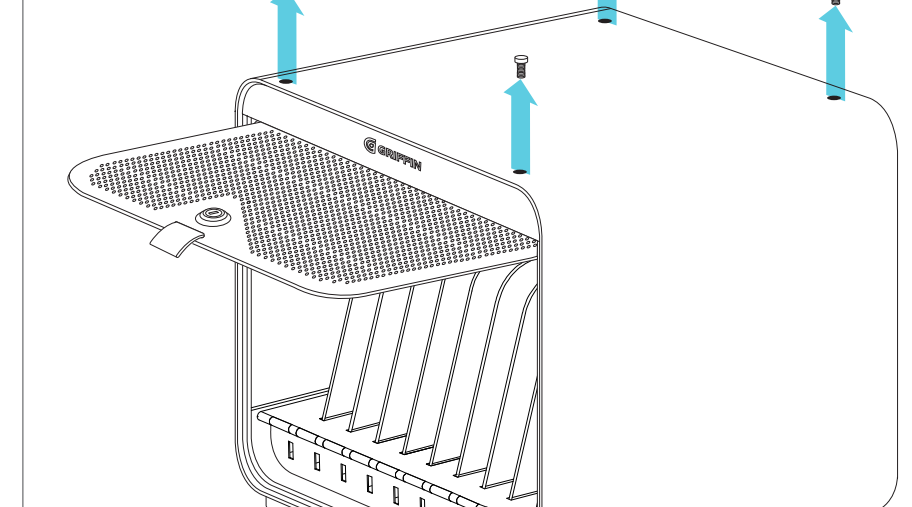

8. Branchez un câble de chargement sur chaque prise et le connecteur USB de chaque câble de chargement sur MultiDock.

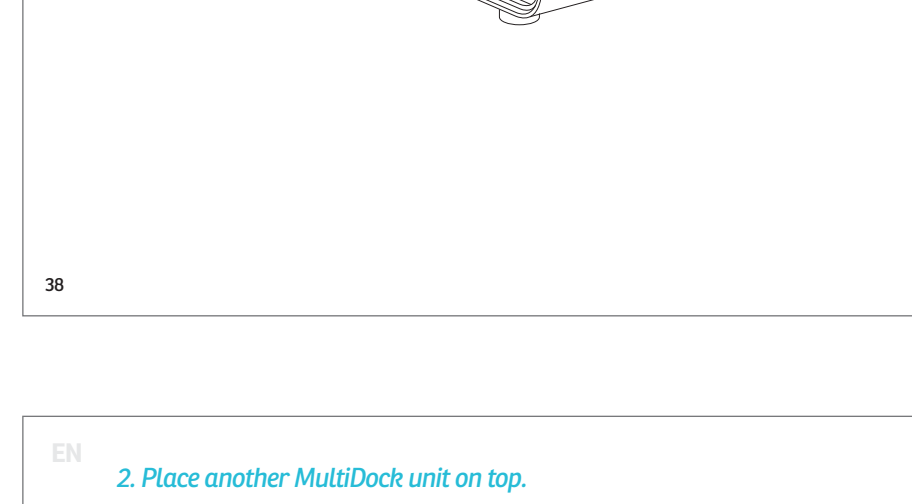

8. Plug a charging cable into each dock, and the USB end of each charging cable into MultiDock.

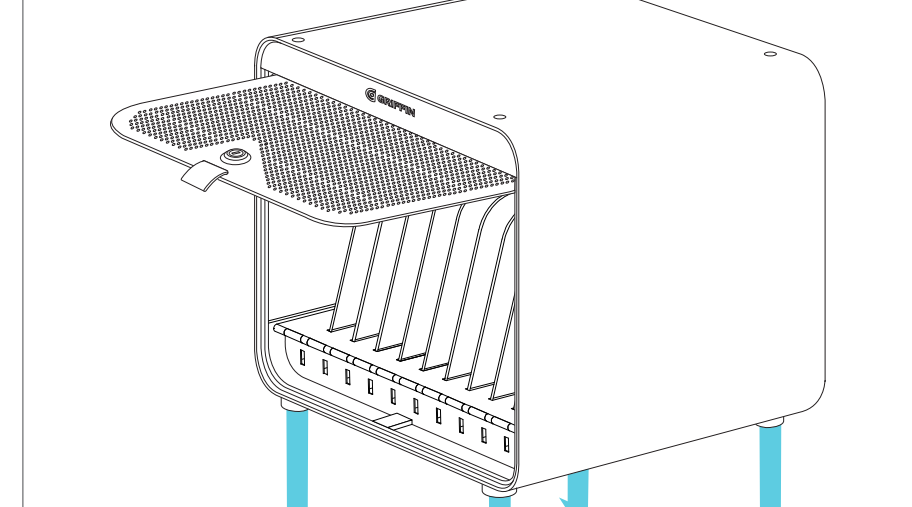

8. Plug a charging cable into each dock, and the USB end of each charging cable into MultiDock.



8. Branchez un câble de chargement sur chaque prise et le connecteur USB de chaque câble de chargement sur MultiDock.

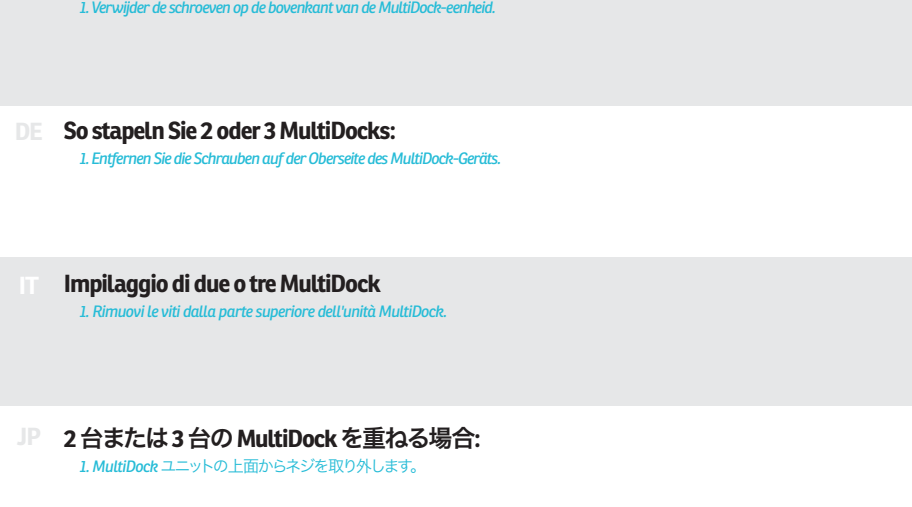

8. Branchez un câble de chargement sur chaque prise et le connecteur USB de chaque câble de chargement sur MultiDock.

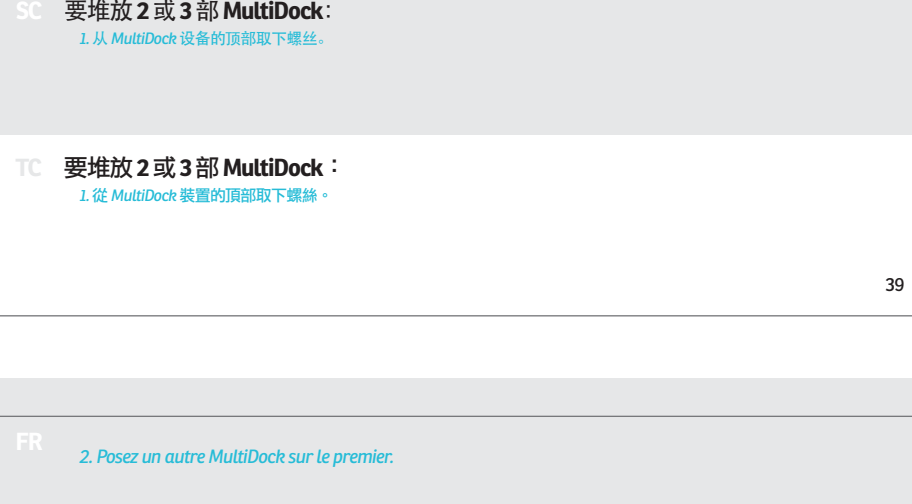

8. Branchez un câble de chargement sur chaque prise et le connecteur USB de chaque câble de chargement sur MultiDock.



8. Branchez un câble de chargement sur chaque prise et le connecteur USB de chaque câble de chargement sur MultiDock.

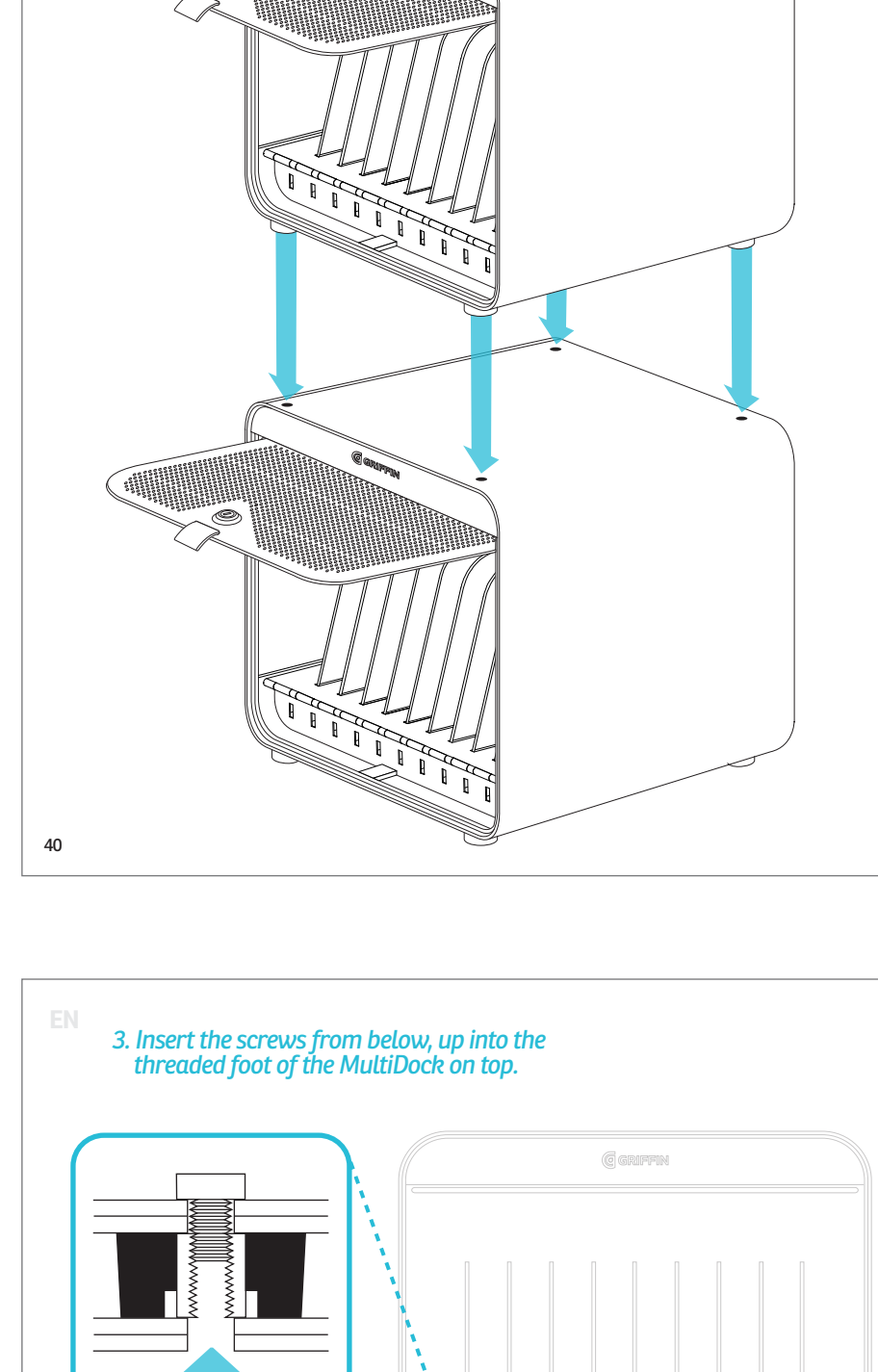

9. Slide the front door open and slide it into its self-storage slot at the top.

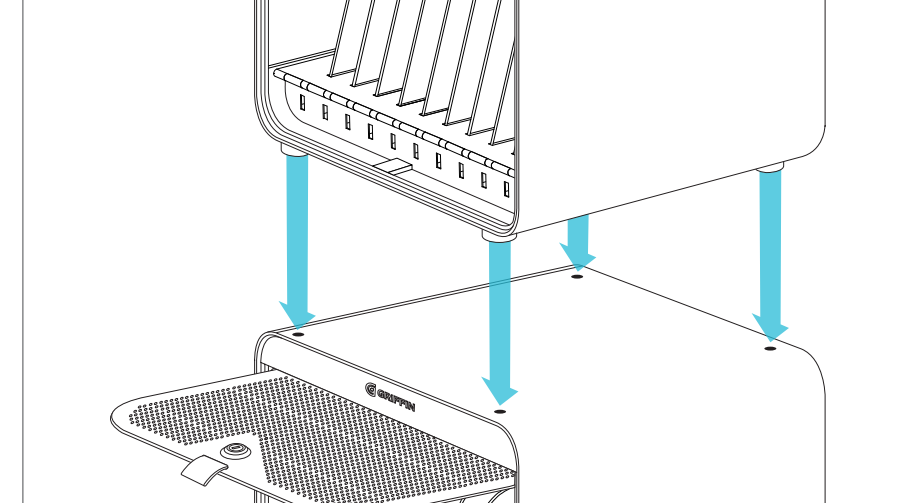

9. Faites glisser la porte avant ouverte et glissez-la dans sa fente de rangement auto-stockage en haut.

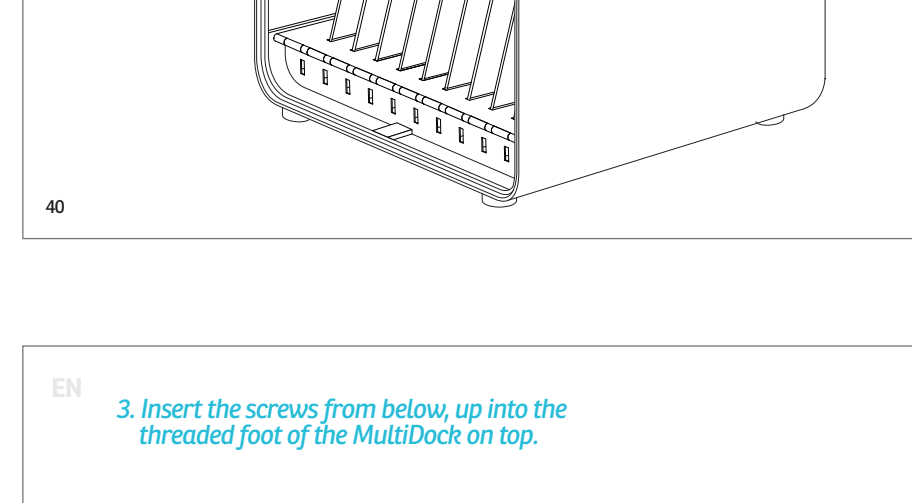

9. Slide the front door open and slide it into its self-storage slot at the top.

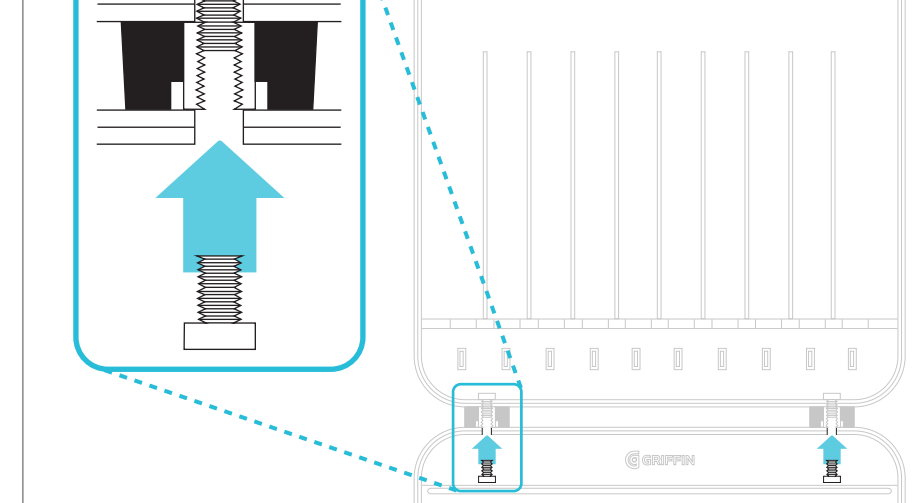

9. Slide the front door open and slide it into its self-storage slot at the top.



9. Faites glisser la porte avant ouverte et glissez-la dans sa fente de rangement auto-stockage en haut.



9. Faites glisser la porte avant ouverte et glissez-la dans sa fente de rangement auto-stockage en haut.

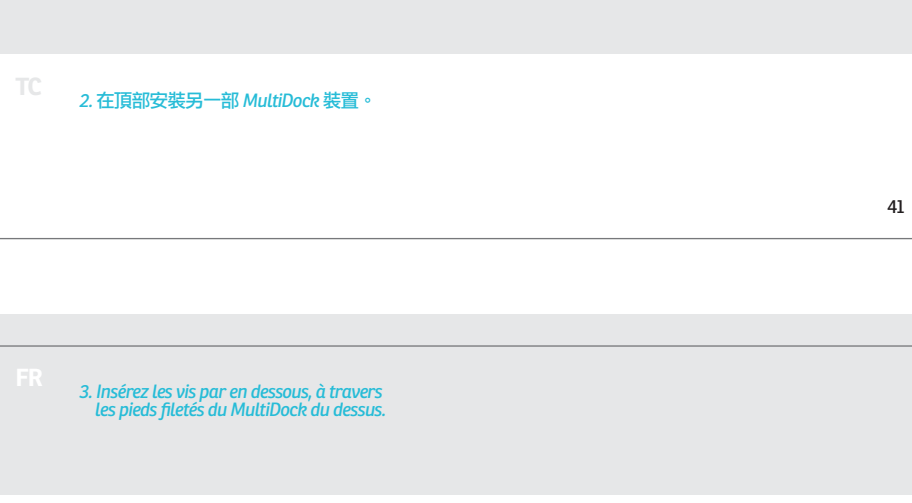

9. Faites glisser la porte avant ouverte et glissez-la dans sa fente de rangement auto-stockage en haut.

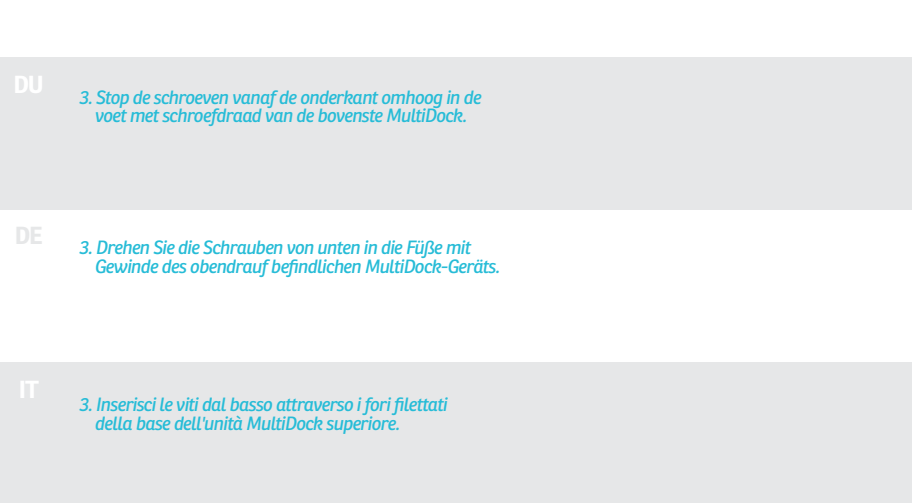

9. Faites glisser la porte avant ouverte et glissez-la dans sa fente de rangement auto-stockage en haut.

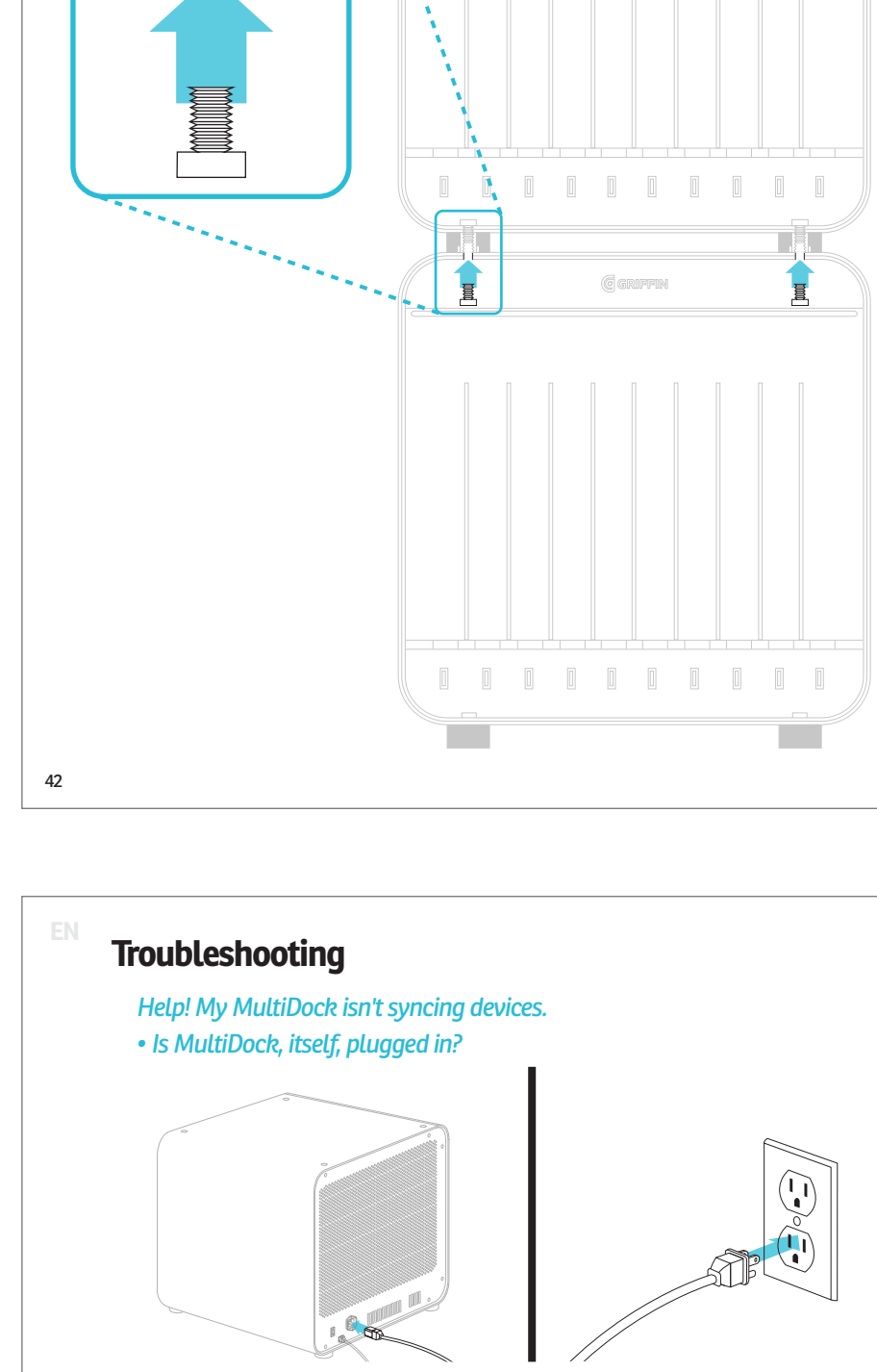

10. Stack 2 or 3 MultiDocks: 1. Remove the screws from the top of the MultiDock unit.

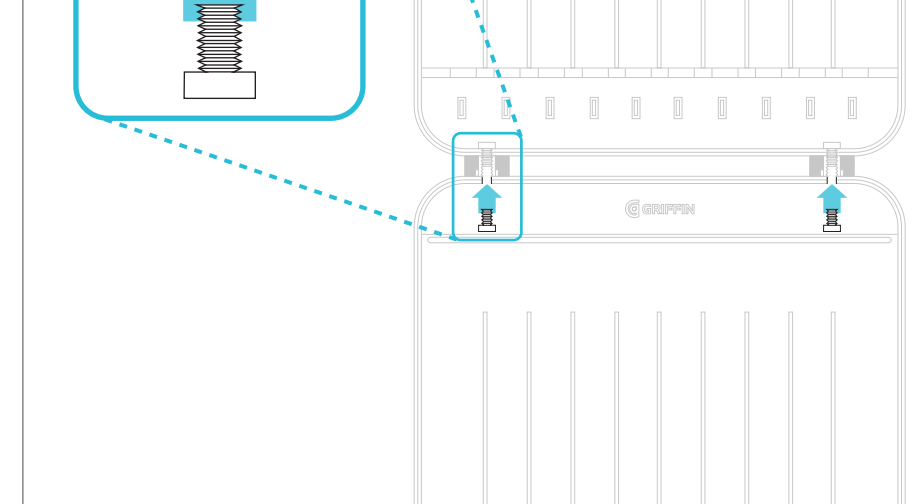

10. Empiler 2 ou 3 MultiDocks: 1. Retirez les vis de la partie supérieure de l'unité MultiDock.

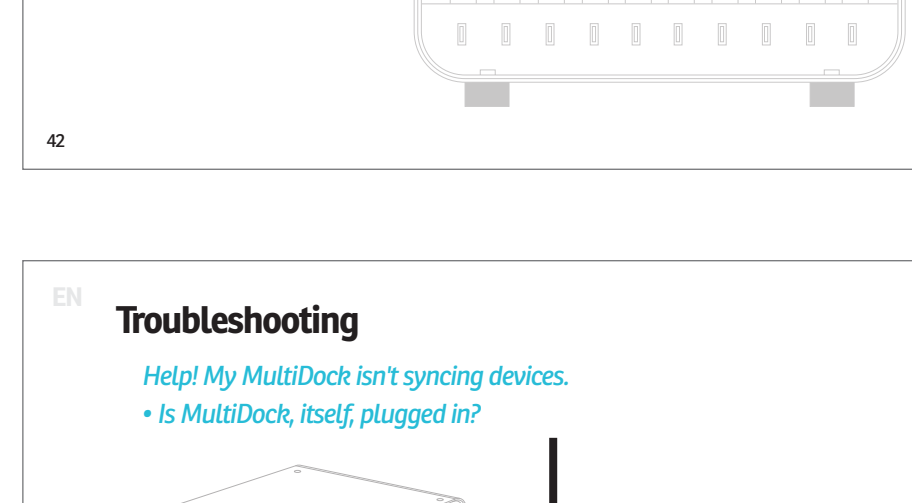

10. Stack 2 or 3 MultiDocks: 1. Remove the screws from the top of the MultiDock unit.

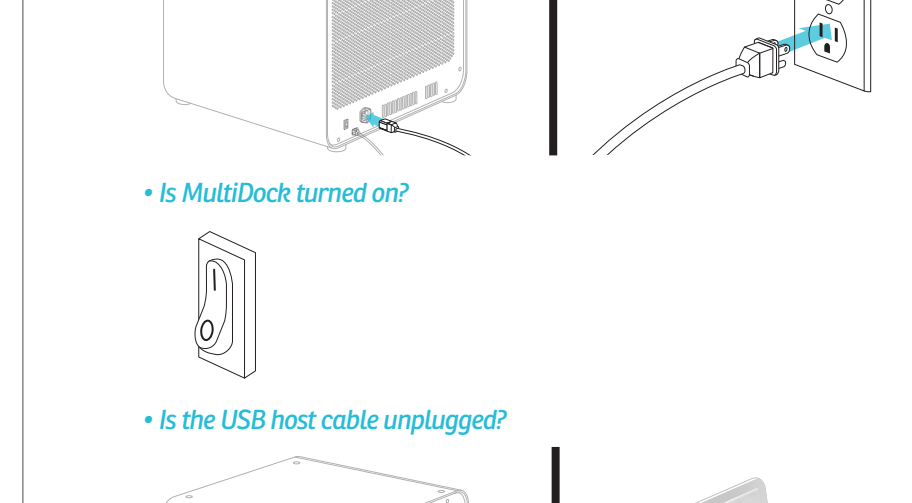

10. Stack 2 or 3 MultiDocks: 1. Remove the screws from the top of the MultiDock unit.

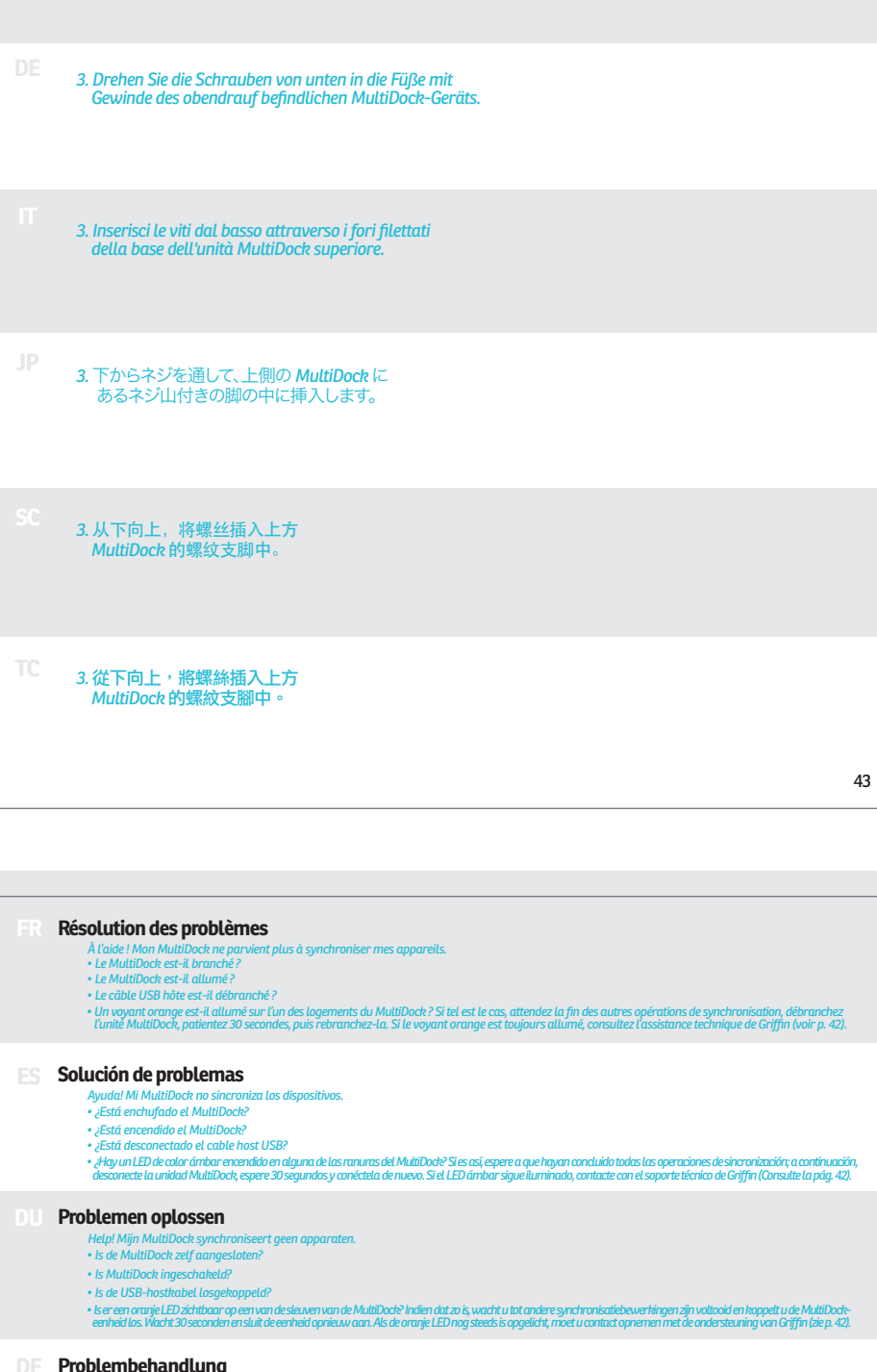

10. Empiler 2 ou 3 MultiDocks: 1. Retirez les vis de la partie supérieure de l'unité MultiDock.



10. Empiler 2 ou 3 MultiDocks: 1. Retirez les vis de la partie supérieure de l'unité MultiDock.

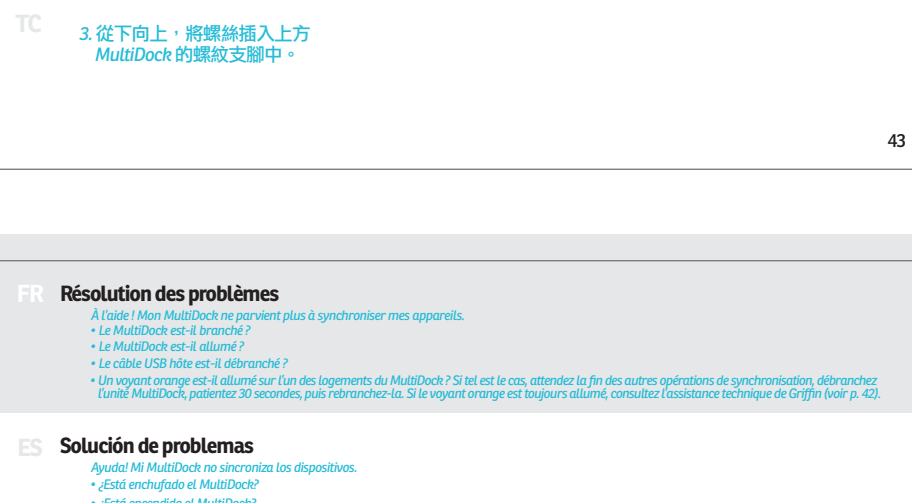

10. Empiler 2 ou 3 MultiDocks: 1. Retirez les vis de la partie supérieure de l'unité MultiDock.

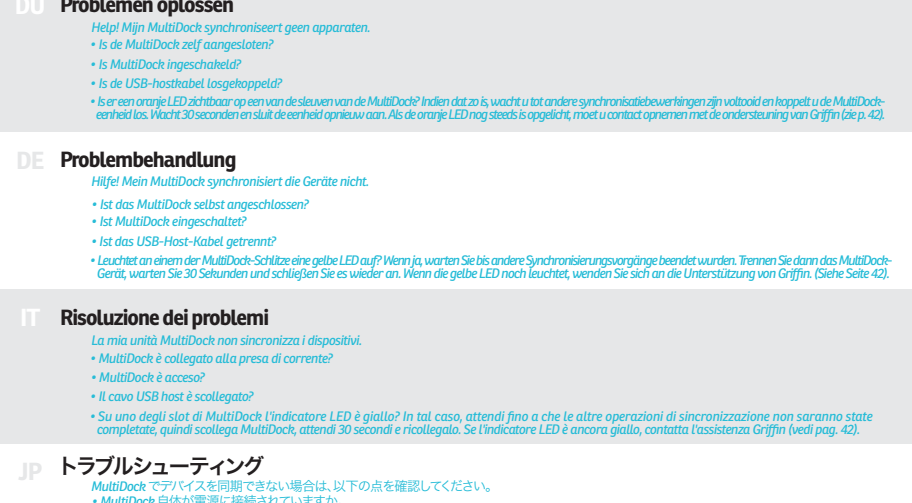

10. Empiler 2 ou 3 MultiDocks: 1. Retirez les vis de la partie supérieure de l'unité MultiDock.

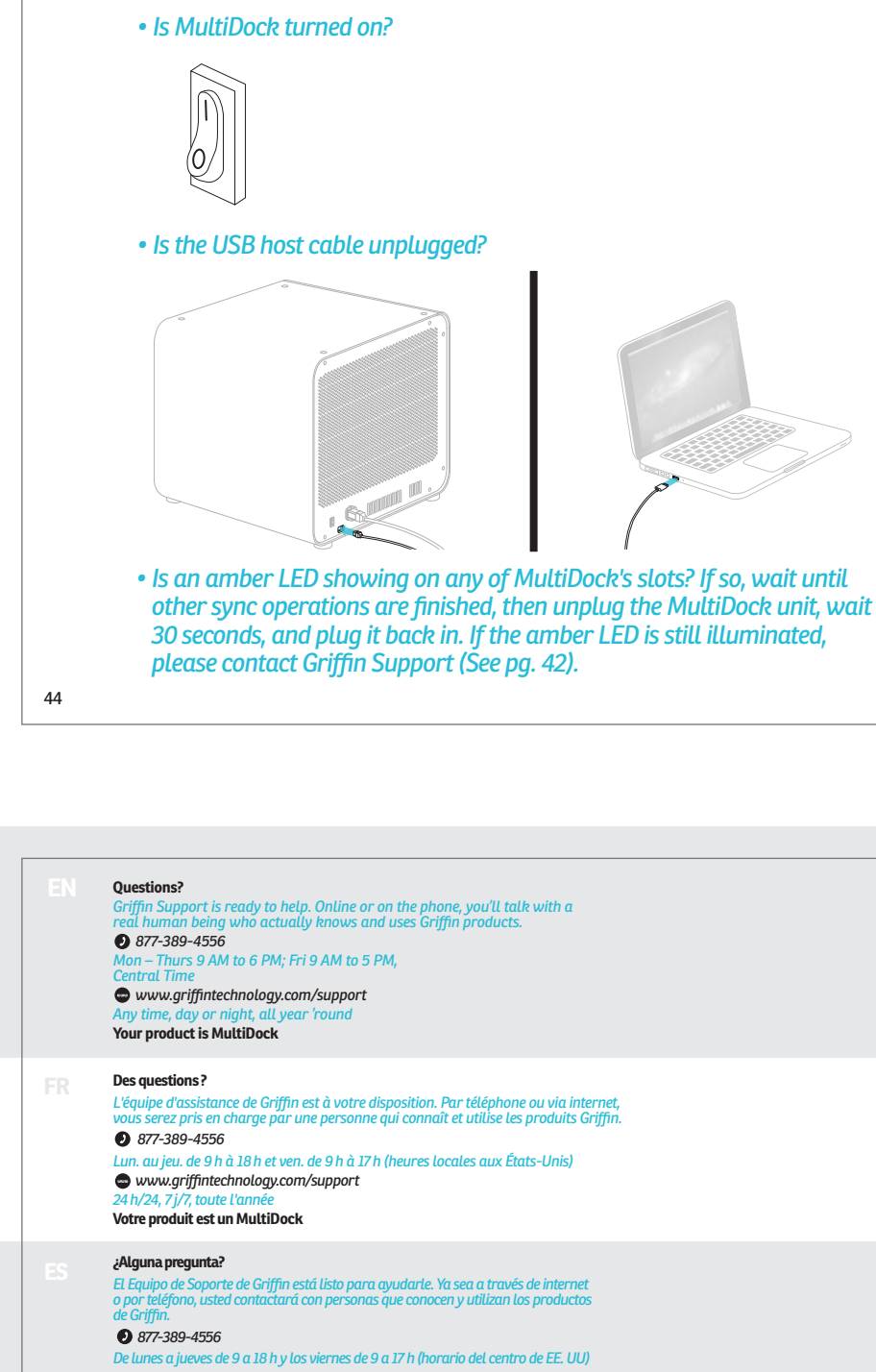

11. Troubleshooting: Help! My MultiDock isn't plugged in?

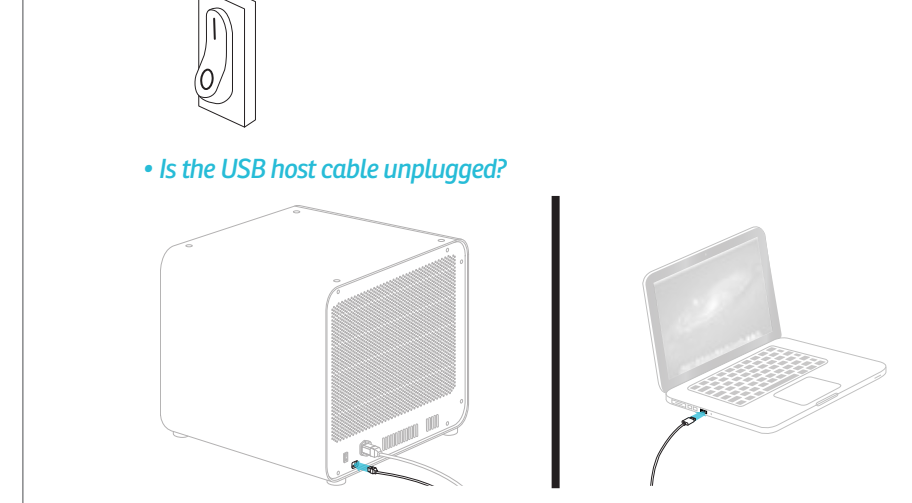

11. Troubleshooting: Help! My MultiDock isn't plugged in?

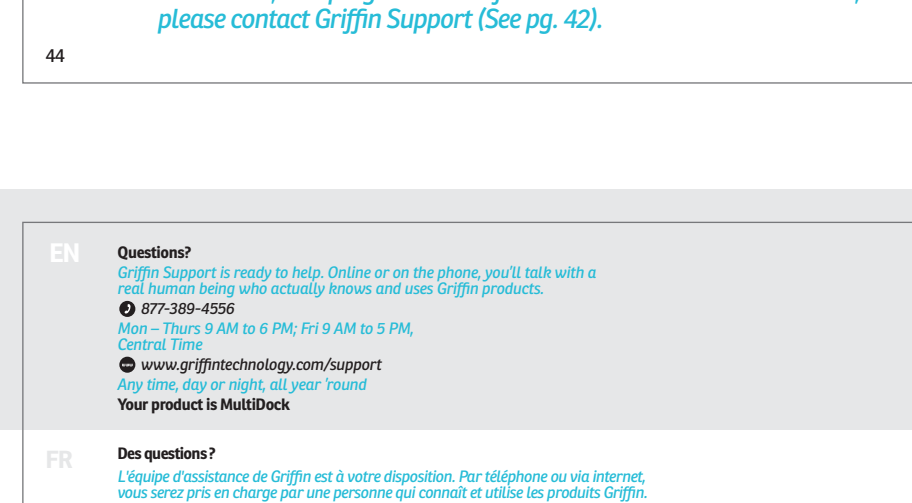

11. Troubleshooting: Help! My MultiDock isn't plugged in?



11. Troubleshooting: Help! My MultiDock isn't plugged in?

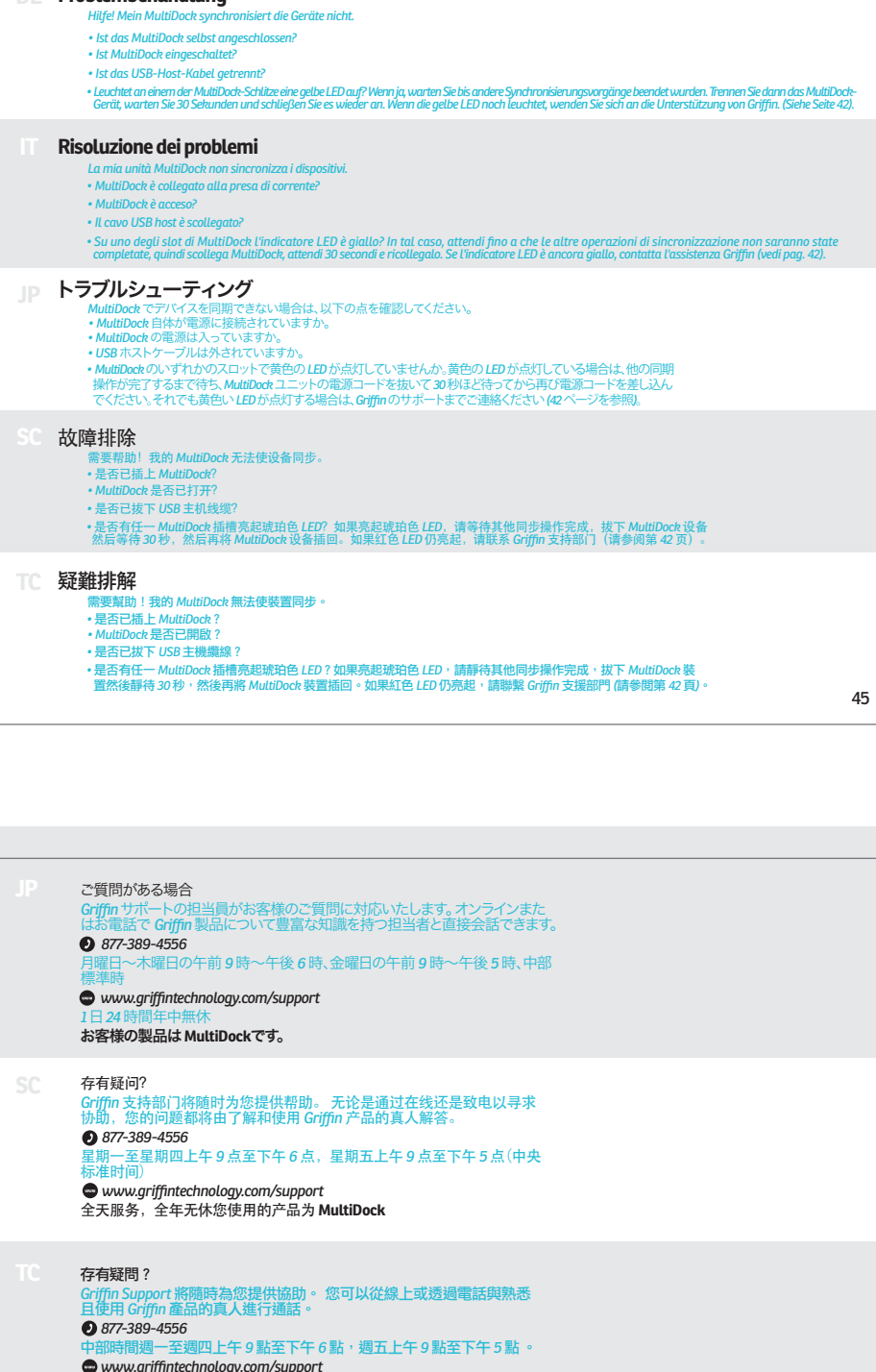

11. Troubleshooting: Help! My MultiDock isn't plugged in?

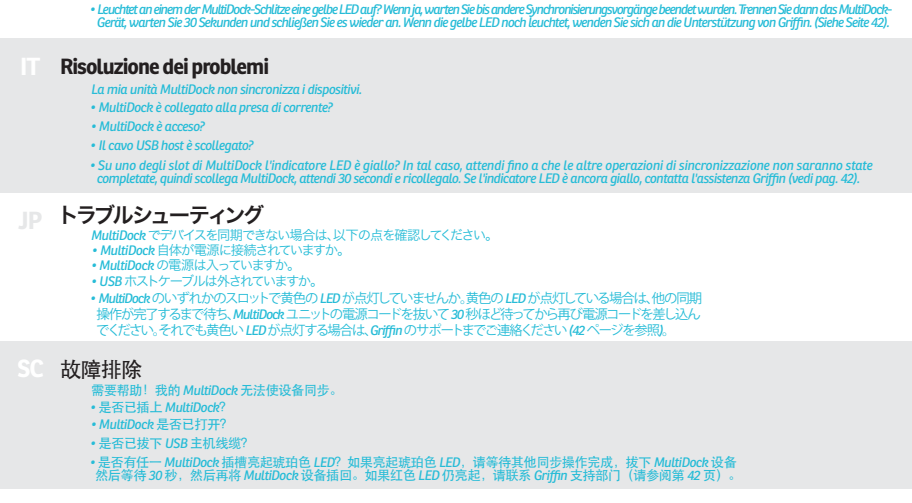

11. Troubleshooting: Help! My MultiDock isn't plugged in?

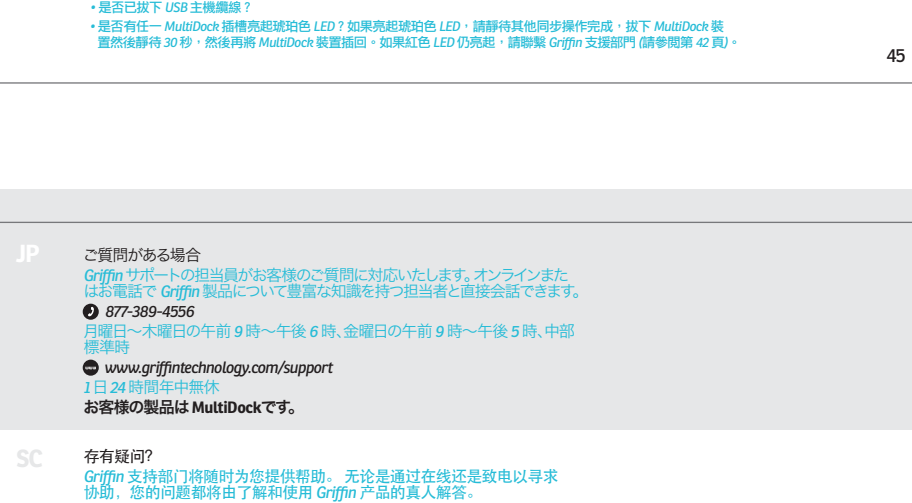

11. Troubleshooting: Help! My MultiDock isn't plugged in?



11. Troubleshooting: Help! My MultiDock isn't plugged in?

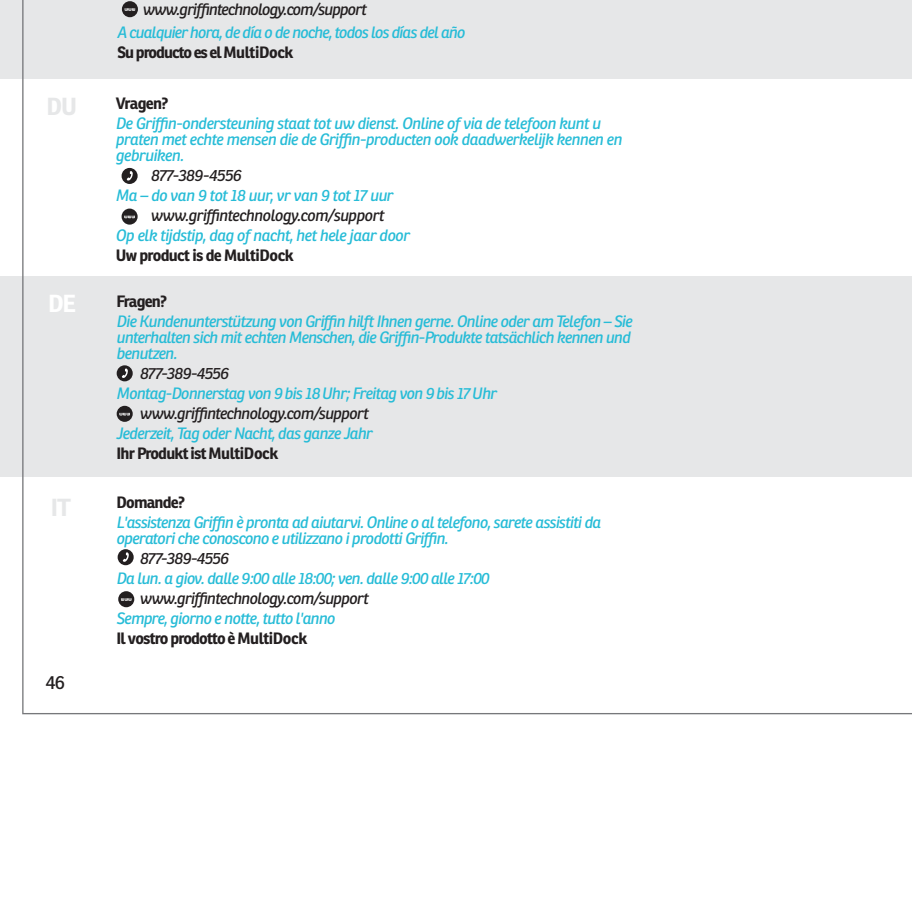

12. Now, configure each iPad for use with MultiDock. You will need to configure each iPad only once.



12. Maintenant, configurez chaque iPad pour son utilisation avec MultiDock. Vous devrez configurer chaque iPad une seule fois.



12. Now, configure each iPad for use with MultiDock. You will need to configure each iPad only once.

12. Now, configure each iPad for use with MultiDock. You will need to configure each iPad only once.



12. Maintenant, configurez chaque iPad pour son utilisation avec MultiDock. Vous devrez configurer chaque iPad une seule fois.

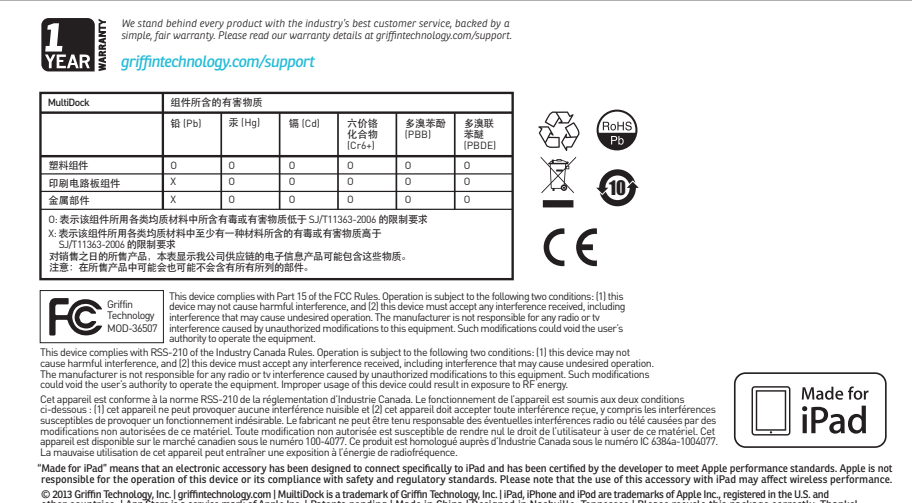

12. Maintenant, configurez chaque iPad pour son utilisation avec MultiDock. Vous devrez configurer chaque iPad une seule fois.

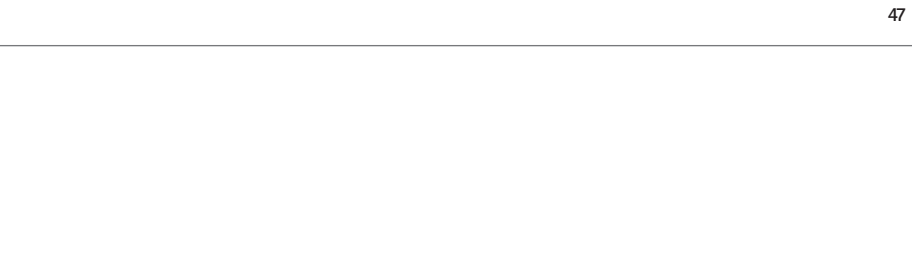

12. Maintenant, configurez chaque iPad pour son utilisation avec MultiDock. Vous devrez configurer chaque iPad une seule fois.

12. Maintenant, configurez chaque iPad pour son utilisation avec MultiDock. Vous devrez configurer chaque iPad une seule fois.

13. Open iTunes.

13. Ouvrez iTunes.

13. Open iTunes.

13. Open iTunes.

13. Ouvrez iTunes.

13. Ouvrez iTunes.

13. Ouvrez iTunes.

13. Ouvrez iTunes.

14. Connect MultiDock's USB cable to your computer.

14. Branchez le câble USB de MultiDock sur votre ordinateur.

14. Connect MultiDock's USB cable to your computer.

14. Connect MultiDock's USB cable to your computer.

14. Branchez le câble USB de MultiDock sur votre ordinateur.

14. Branchez le câble USB de MultiDock sur votre ordinateur.

14. Branchez le câble USB de MultiDock sur votre ordinateur.

14. Branchez le câble USB de MultiDock sur votre ordinateur.

15. Sync: First, configure your host computer. You will need to configure each iPad only once.

15. Synchronisation: Premièrement, configurez votre ordinateur hôte. Vous devrez configurer chaque iPad une seule fois.

15. Sync: First, configure your host computer. You will need to configure each iPad only once.

15. Sync: First, configure your host computer. You will need to configure each iPad only once.