

HUDSON 500/600



EN - This tent should be erected by at least 2 people

CZ - Tento stan by měl být postaven nejméně 2 osoby

DE - Dieses Zelt sollte von mindestens zwei Personen aufgestellt werden

FR - Cette tente doit être érigée par au moins 2 personnes

IT - Questa tenda deve essere eretta da almeno 2 persone

NL - Deze tent moet worden omgeven door minstens 2 personen

PITCHING

A.

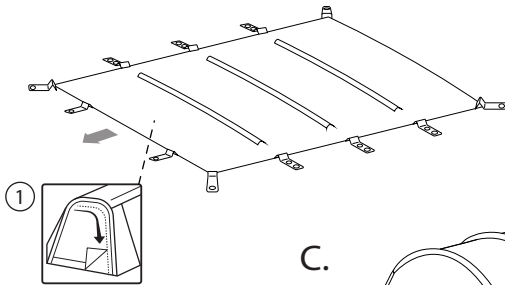

B.

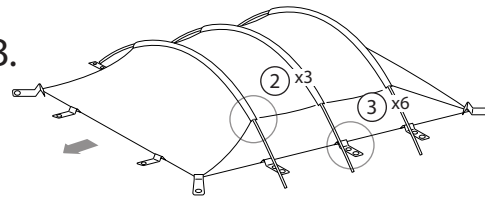

C.

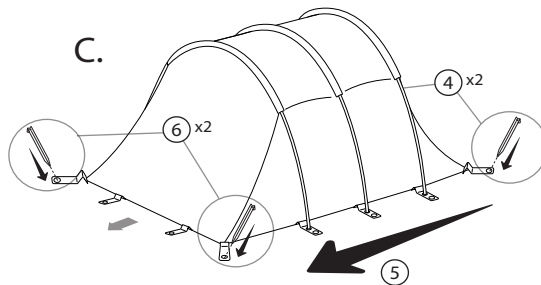

D.

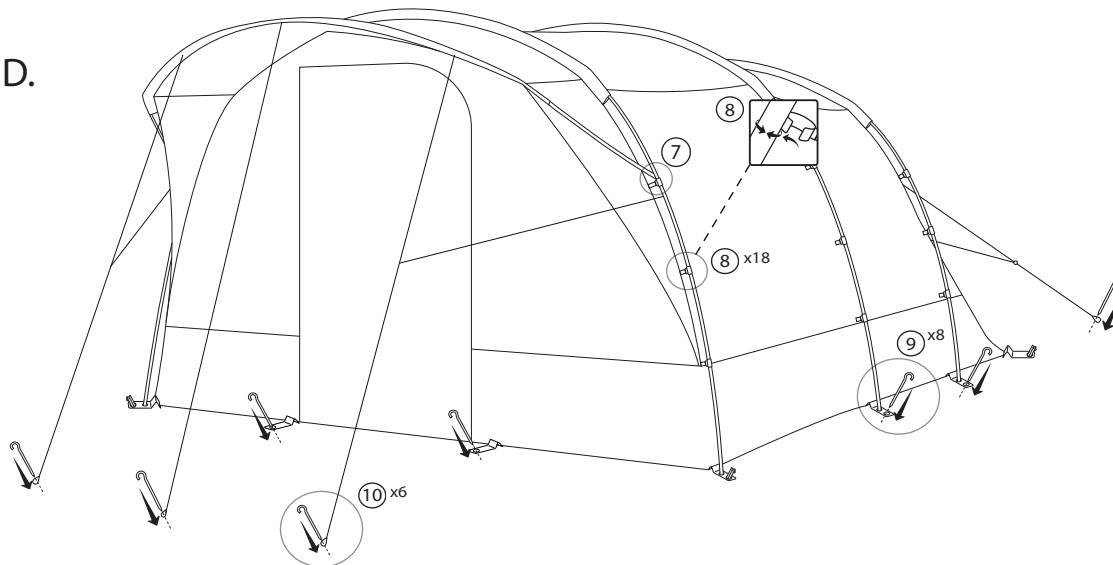

C.

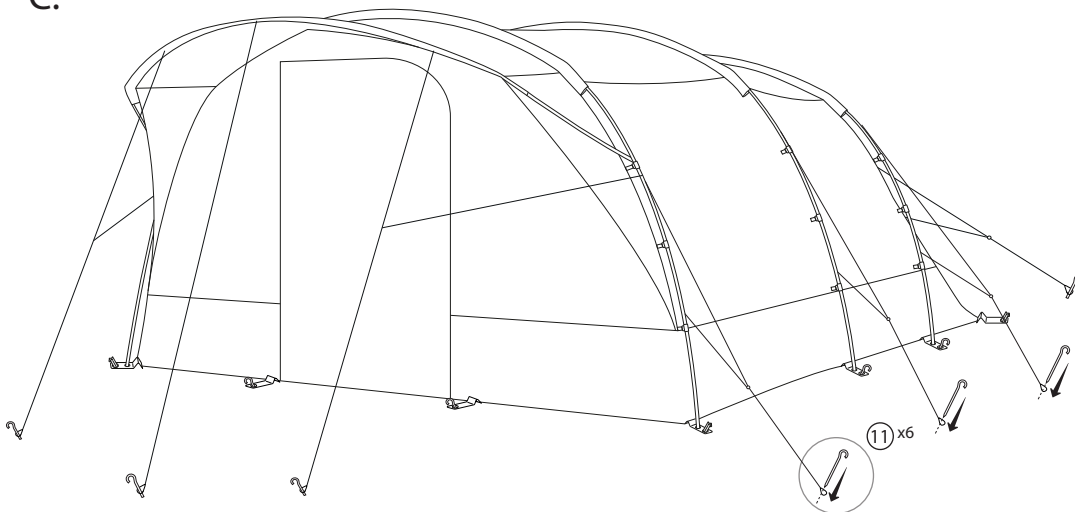

Poles

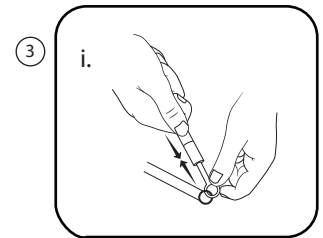
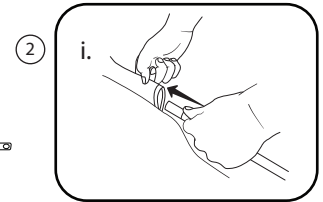

Over Door Canopy

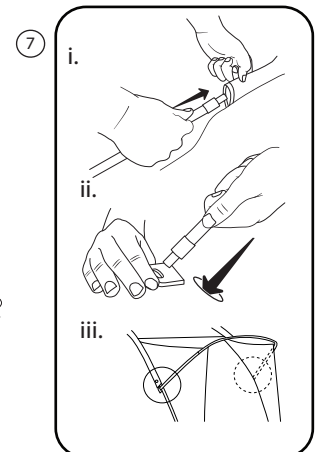

TBS® II

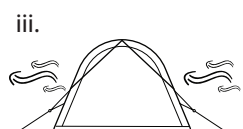
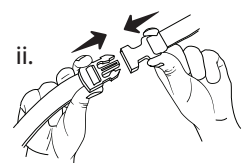
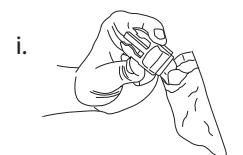

HUDSON 500/600



EN - This tent should be erected by at least 2 people

CZ - Tento stan by měl být postaven nejméně 2 osobami

DE - Dieses Zelt sollte von mindestens zwei Personen aufgestellt werden

FR - Cette tente doit être érigée par au moins 2 personnes

IT - Questa tenda deve essere eretta da almeno 2 persone

NL - Deze tent moet worden omgeven door minstens 2 personen

TAKING DOWN & PACKING

A.

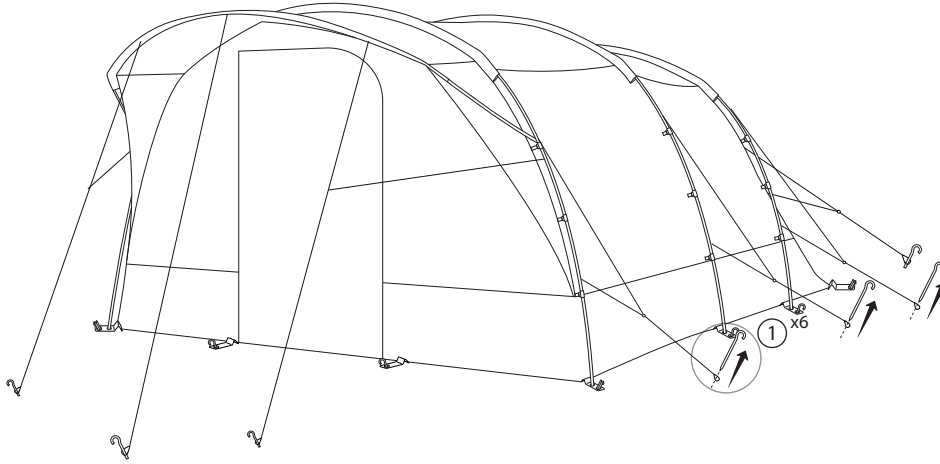

Over Door Canopy

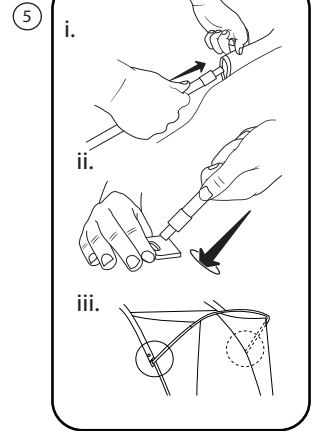

B.

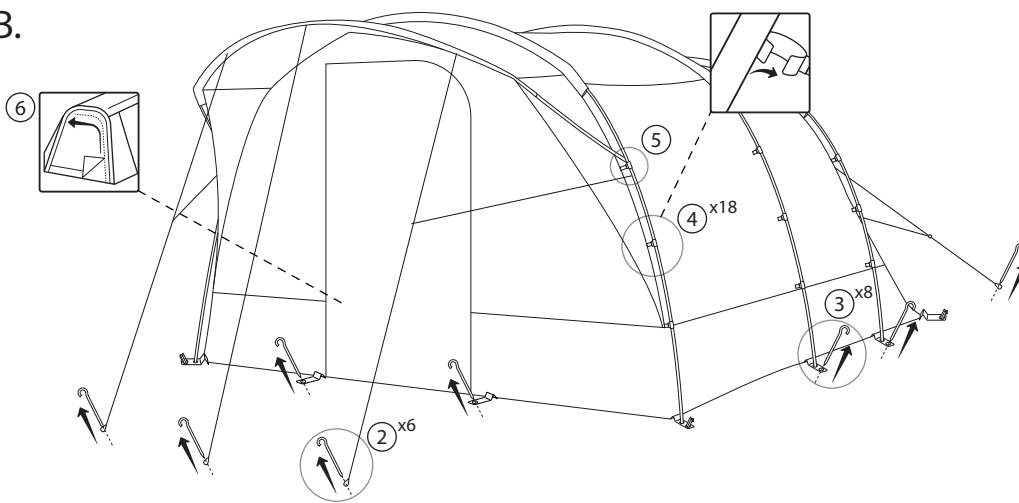

Poles

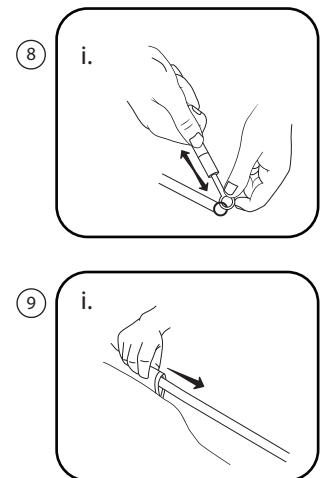

C.

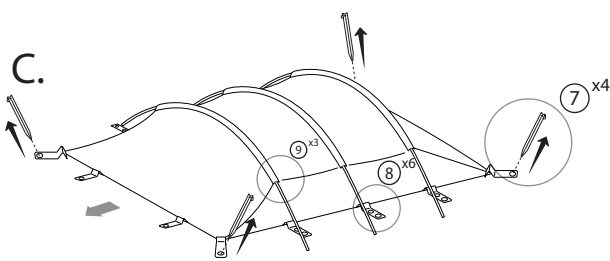

D.

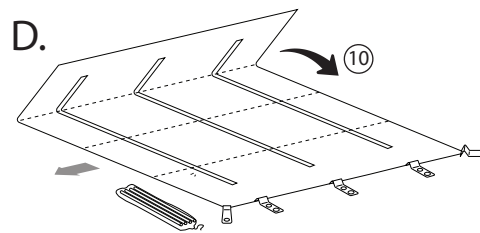

E.

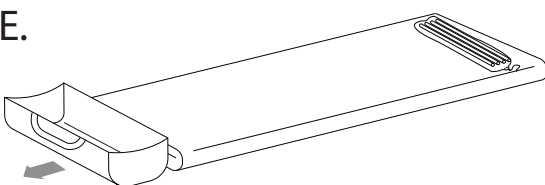

F.

