

PHILIPS

hue personal
wireless
lighting

50471/**/**

50472/**/**

50473/**/**

50474/**/**



50471/**/**



50472/**/**



50473/**/**



50474/**/**



Gebruiksaanwijzing
Notice d'emploi
Benutzerhandbuch
User manual
Manual de usuario

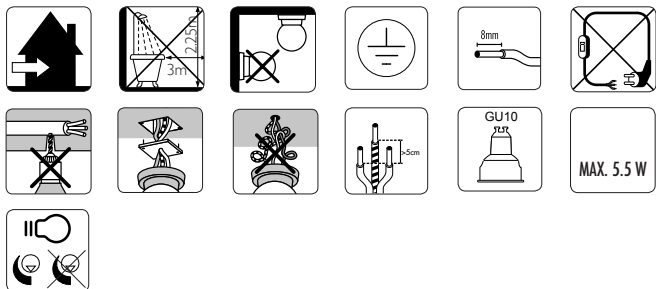
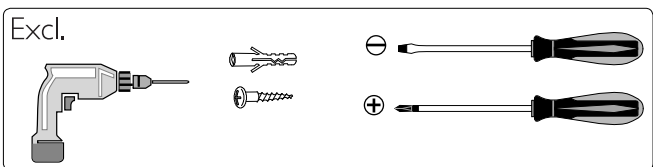
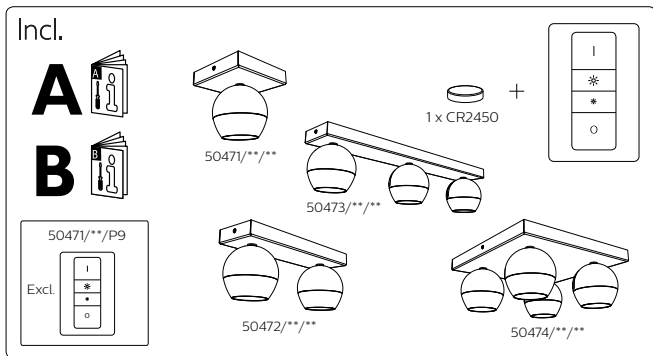

www.meethue.com/getstarted



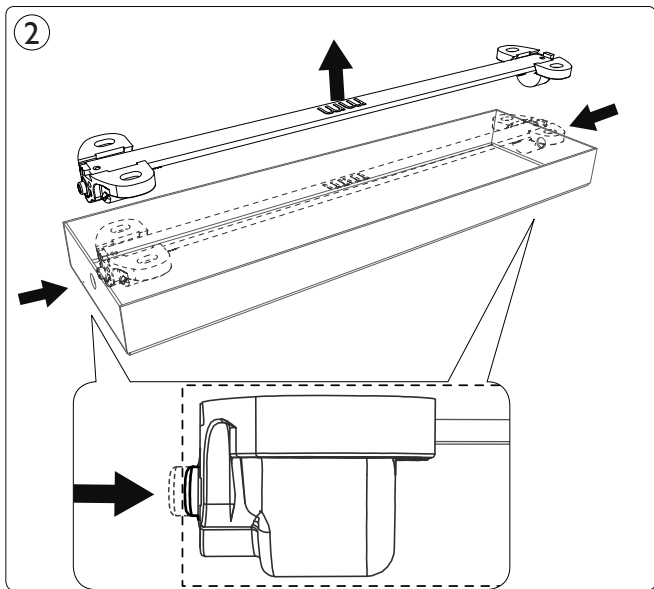
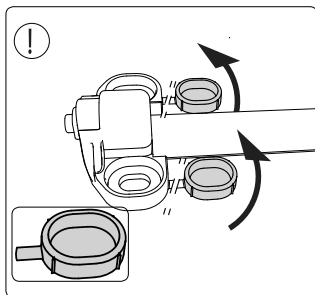
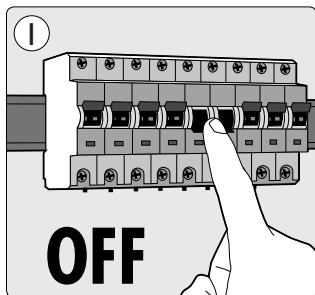

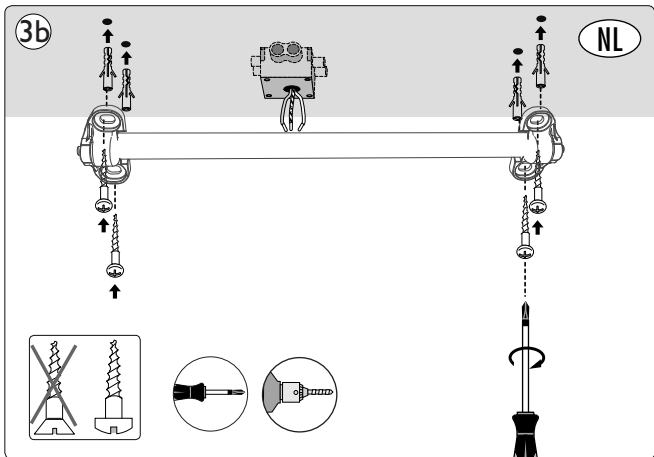
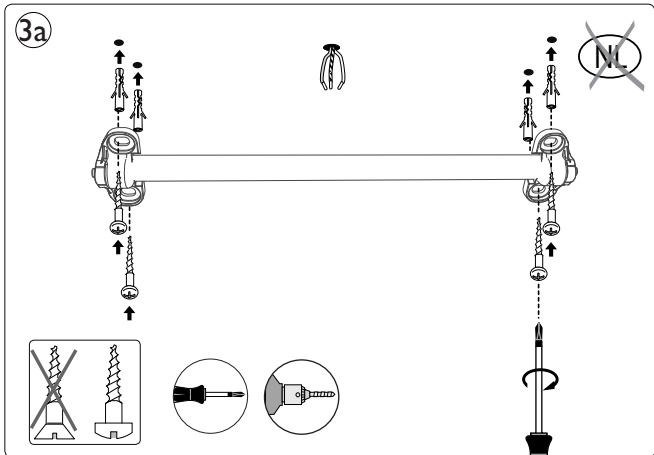

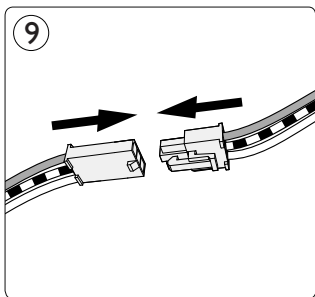
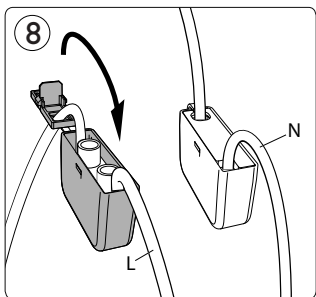
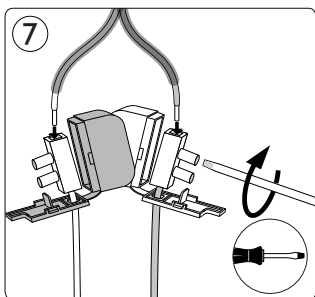
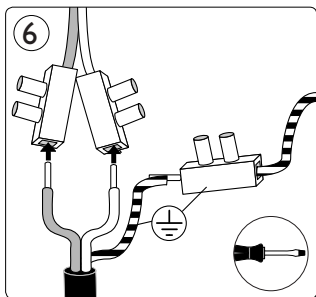
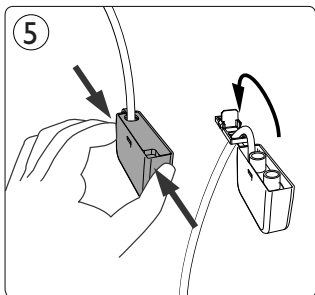
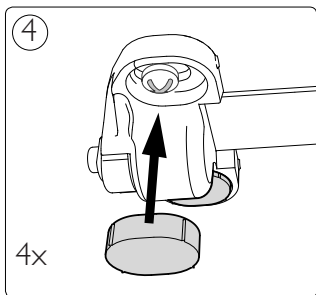

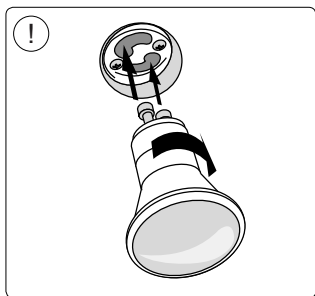
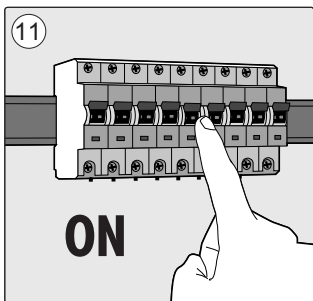
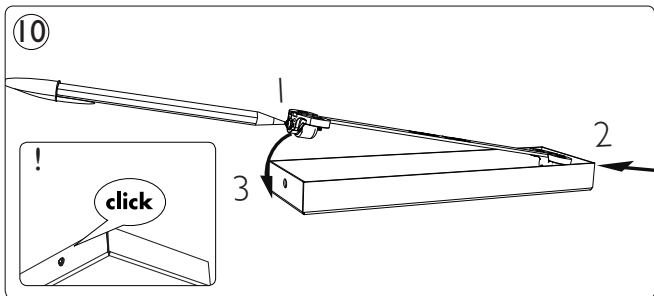

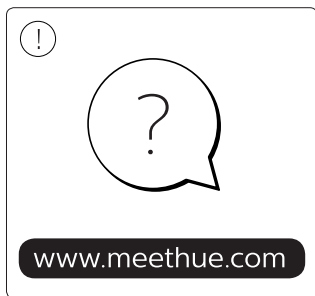
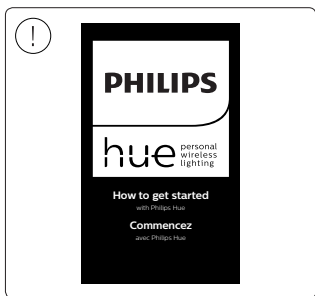
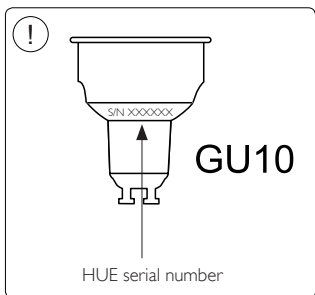
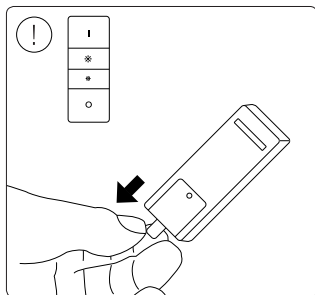
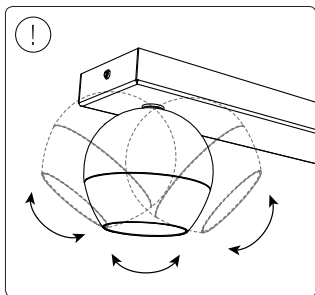



Signify
I.B.R.S. / C.C.R.I. Numéro 10461
5600 VB Eindhoven,
the Netherlands
☎00800-74454775

© 2019 Signify Holding
All rights reserved.

www.meethue.com

4404 029 07733
Last update: 29/08/19