



# VITAMIX® 5200

## Owner's Manual

Read and save these instructions



Vita-Mix® Corporation  
8615 Usher Road  
Cleveland, OH 44138-2103 U.S.A.  
1-800-848-2649 / 1-440-235-4840  
[www.vitamix.com](http://www.vitamix.com)

# LET'S GET STARTED

## **Congratulations!**

You are about to see how quick, easy, and delicious healthy eating can be! We hope that you'll find the information in this step-by-step guide to be useful and beneficial. The possibilities are endless, and we know you will enjoy your new Vitamix lifestyle!

Please read all the safety information, warnings, and instructional material found in this booklet before getting started. Set your Vitamix machine on a dry, level surface. Make sure that the power switch is set to Off (O), and that the machine is plugged into a grounded electrical outlet. Then, follow the cleaning instructions on page 14 to prepare your machine for use. Always clean your machine before the first use.

# SERVICE & REGISTRATION

## Vitamix Service

Record the model number and serial number of your Vitamix in the spaces provided below for future reference. These numbers can be found on the back of the motor base.

Model Number \_\_\_\_\_

Serial Number \_\_\_\_\_

Date of Purchase \_\_\_\_\_

Purchased From \_\_\_\_\_

Before returning this product for any reason, including repair, first contact Vitamix Customer Service at 1-800-848-2649 or 1-440-235-4840, email [service@vitamix.com](mailto:service@vitamix.com), or contact your local dealer.

## Product Registration

If you purchased your Vitamix® machine directly from the Vita-Mix® Corporation via the company's website or call center by phone, your product was registered at the time of purchase and your Vitamix machine's warranty has been activated.

If you purchased your Vitamix machine from an International Distributor or Dealer in countries other than the United States, Canada, United Kingdom, or Ireland, your product is warranted through the International Distributor or Dealer and need not be registered with the Vita-Mix Corporation.

### Your machine is not yet registered with Vitamix if you:

1. Purchased from a Dealer in the United States, Canada, United Kingdom, or Ireland
2. Purchased from a military base
3. Purchased from a retail or wholesale store
4. Received your Vitamix machine as a gift
5. Are not the original owner of the machine

Enjoy faster and easier service in the future by taking a few minutes to register your Vitamix machine today.

### Choose one of these easy ways to register your machine:

1. Online at [www.vitamix.com/warranty](http://www.vitamix.com/warranty)
2. Email [service@vitamix.com](mailto:service@vitamix.com)
3. Call 1-800-848-2649 or 1-440-235-4840, press option 2

Your warranty may be honored by Vita-Mix® Corporation or an authorized dealer.

Failure to register your machine will not diminish your warranty rights.

# IMPORTANT SAFEGUARDS

 **WARNING:** To avoid the risk of serious injury when using your Vitamix® blender, basic safety precautions should be followed, including the following.



## **READ ALL INSTRUCTIONS, SAFEGUARDS, AND WARNINGS BEFORE OPERATING BLENDER.**

1. Read all instructions.
2. Not intended for use by or near children or persons with reduced physical, sensory, or mental capabilities or lack of experience and knowledge. Close supervision is necessary when any appliance is used by or near children or incapacitated persons.
3. To protect against the risk of electrical shock, do not put the blender base in water or other liquid.
4. Unplug from outlet when not in use, before putting on or taking off parts, and before cleaning.
5. Avoid contacting moving parts.
6. Do not operate any appliance with a damaged cord or plug or after the appliance malfunctions, or is dropped or damaged in any manner. Call Vitamix Customer Service at 1-800-848-2649 or 1-440-235-4840 or email [service@vitamix.com](mailto:service@vitamix.com) at once for examination, repair, replacement, or electrical or mechanical adjustment. If purchased outside the U.S.A. or Canada, contact your local Vitamix dealer.
7. Alteration or modification of any part of the blender base or container, including the use of any part or parts that are not genuine authorized Vitamix parts, may cause fire, electric shock, or injury.
8. The use of attachments not expressly authorized or sold by Vitamix for use with this blender, including canning jars, may cause fire, electric shock, or injury.
9. Do not use outdoors.
10. Do not let cord hang over edge of table or counter.
11. Do not let cord contact hot surface, including the stove.
12. Keep hands and utensils out of container while blending to reduce the risk of severe injury to persons or damage to the blender. A rubber scraper or spatula may be used, but only when the Vitamix blender is not running.
13. The tamper provided must be used only when the main part of the lid is in place.
14. Blades are sharp. Handle or remove blade and blade assembly from the container with extreme care to avoid injury. To reduce the risk of injury, never place a blade assembly on the motor base unless assembled to the Vitamix container.
15. Do not leave foreign objects, such as spoons, forks, knives or the lid plug, in the container as this will damage the blades and other components when starting the machine and may cause injury.
16. Never attempt to operate with damaged blades.

# IMPORTANT SAFEGUARDS

17. Always operate blender with lid and lid plug firmly in place. The lid plug should be removed only when adding ingredients and when using the tamper.
18. When blending hot liquids or ingredients, use caution; spray or escaping steam may cause scalding and burns. Do not fill container to the maximum capacity. Always begin processing on the lowest speed setting, variable speed 1. Keep hands and other exposed skin away from the lid opening to prevent possible burns.
19. When making nut butters or oil-based foods, do not process for more than one minute after the mixture starts to circulate in the container. Processing for longer periods can cause dangerous overheating.

## SAVE THESE INSTRUCTIONS

⚠ WARNING		
	<p><b>To Avoid Injury.</b> Read and understand instruction manual before using this machine.</p>	

### IMPORTANT INSTRUCTIONS FOR SAFE USE

This product is intended for HOUSEHOLD USE ONLY and is not intended to be used for commercial purposes.

Do not leave your Vitamix blender unattended when operating.

Any repair, servicing, or the replacement of parts must be performed by Vitamix or an authorized service representative.

⚠ WARNING	
	<p><b>Electrical Shock Hazard.</b> Use grounded outlet only. <b>DO NOT</b> remove ground. <b>DO NOT</b> use an adapter. <b>DO NOT</b> use an extension cord. <b>Failure to follow instructions can cause death or electrical shock.</b></p>

**NOTICE:** THE FAILURE TO FOLLOW ANY OF THE IMPORTANT SAFEGUARDS AND THE IMPORTANT INSTRUCTIONS FOR SAFE USE IS A MISUSE OF YOUR VITAMIX BLENDER THAT CAN VOID YOUR WARRANTY AND CREATE THE RISK OF SERIOUS INJURY.

# PARTS & FEATURES

**2-Part Lid:** Your new machine has our latest lid design. It is easy to put on and take off, and easy to clean. Always use the lid and the lid plug when the machine is in operation.

**!** **CAUTION:** Lids are not interchangeable between different container styles, types, and sizes.

Snap the lid onto the container and leave in place for a few minutes. Once the lid has been left on the container, it will be much easier to lock or remove.

**Lid Plug:** Insert through the lid and secure by turning clockwise. Remove the lid plug to use the tamper or add ingredients.

## To Lock the Lid in Place:

1. Position lid on container with lid flaps midway between the spout and the handle.
2. Push the lid onto the container until it locks in place.
3. The lid must always be secured when processing, especially hot liquids that may scald.

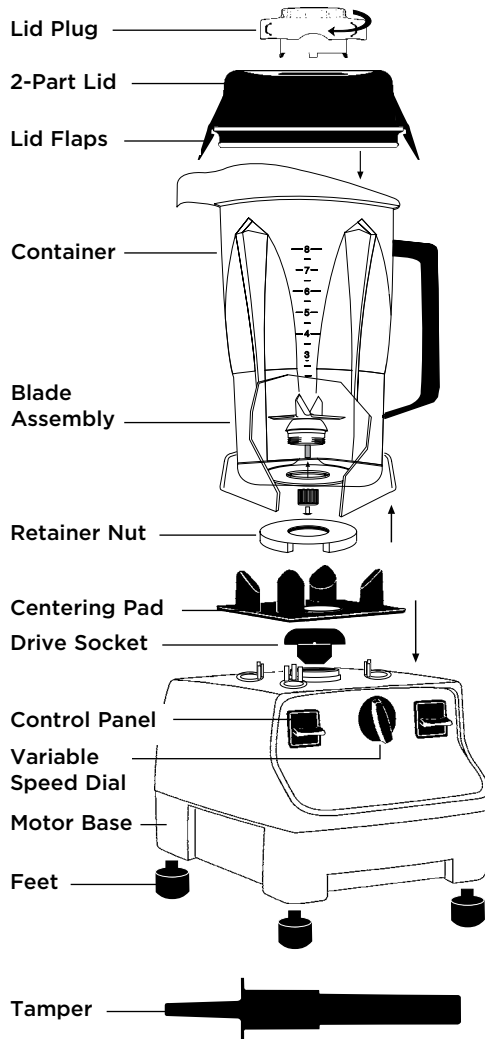

# PARTS & FEATURES

## ⚠ WARNING



**Rotating Blades Can Cause Severe Injury.**  
**DO NOT** reach into container while machine is running.



**To Remove the Lid:** Lift up on one lid flap while holding the container securely.

**To Remove the Lid Plug:** Rotate the lid plug counterclockwise from the “locked” to “unlocked” position and lift out.

**Container:** Ounces, cups, and milliliters are clearly marked. A second dry blade container is available for purchase to grind grain and knead bread dough. The blade is marked “D.” Grinding grains will cloud the lower three inches (8 cm) of the container.

**Automatic Overload Protection:** Your Vitamix motor is designed to protect itself from overheating. If the motor shuts off, follow these instructions:

- **120 Volt machines:** Turn off the power switch for up to 45 minutes to reset. Reset time will be extended if high room temperatures exist. To reduce the reset time, unplug the machine, remove the container, and blow air into the center section of the bottom with a hair dryer on the cool setting.
- **220 Volt machines:** 220/240 motors are equipped with a reset button. If the motor shuts off, press the black reset button on the bottom of the machine.

**Power Cord:** Your machine is equipped with a long power cord. Store the unused portion neatly underneath.

**Bottom View / Cord Wrap:** Plastic cord retainers hold the cord securely. There is no need to unscrew the cord retainers to let out more cord. They are flexible, and return to position after the cord is lifted out.

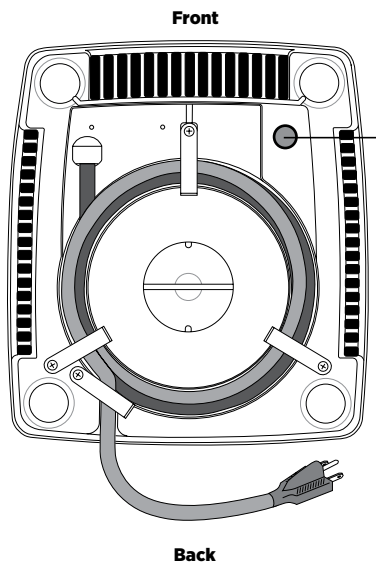

Reset Button: On 220/240 volt machines only.

# ABOUT THE BLADES

The Vitamix machine comes standard with the wet blade container. The blade is identified by a “W” for wet. This blade is used for most of your recipes. Additional containers with wet or dry blades may be purchased separately.

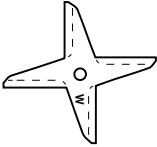

⚠ WARNING		
	<p><b>Rotating Blades Can Cause Severe Injury.</b> <b>DO NOT</b> reach into container while machine is running.</p>	

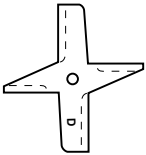

**Wet Blade Container:** Designed for processing liquids, including juice, frozen mixtures, sauces, soups, purees, batters, and for wet chopping. The wet blades can also grind grain and knead dough, but they are not quite as efficient as the dry blades in this application. If used for grinding, your container will mar and become cloudy; see instructions for dry container use.





**Dry Blade Container:** These blades are clearly marked “D” and are designed specifically for grinding dry materials such as grains, cereal, and coffee, and are also used for kneading bread dough. The dry blades can NOT process liquids efficiently. *If you grind herbs on a regular basis, you may wish to purchase a separate dry blade container and replace blades as needed.*

⚠ CAUTION		
	<p><b>Moving Parts May Become Hot With Extended Use.</b> <b>DO NOT</b> touch.</p>	



# HOW TO USE THE TAMPER

The tamper allows you to accelerate the process of very thick and/or frozen mixtures that cannot be processed in a regular blender. Using the tamper maintains circulation by preventing air pockets from forming. While the machine is running, and only through the lid plug opening, use the tamper to press ingredients into the blades as you make frozen ice creams and nut butters, or purée fruits and vegetables.

<b>⚠ WARNING</b>		
	<p><b>Rotating Blades Can Cause Severe Injury.</b></p> <p><b>DO NOT</b> put hands, spatulas, etc. in the container while the machine is running or while the container is still on the base.</p>	

- The splash disk (near the top of the tamper) and lid prevent the tamper from hitting the blades when the lid is secured properly in the locked position.
- The container should not be more than two-thirds full when the tamper is used during blending.
- Do not use the tamper for more than 30 consecutive seconds (to avoid overheating).
- If the food does not circulate, the machine may have trapped an air bubble. Carefully remove the lid plug while making sure the lid stays firmly in place. Release the air bubble by inserting the tamper through the lid plug opening.
- Holding the tamper straight down may not always help the ingredients circulate. If need be, point the tamper toward the side or corner of the container.

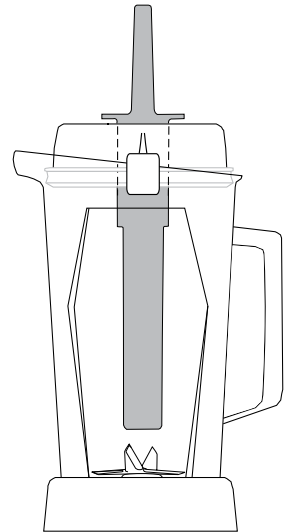

# CONTROL PANEL

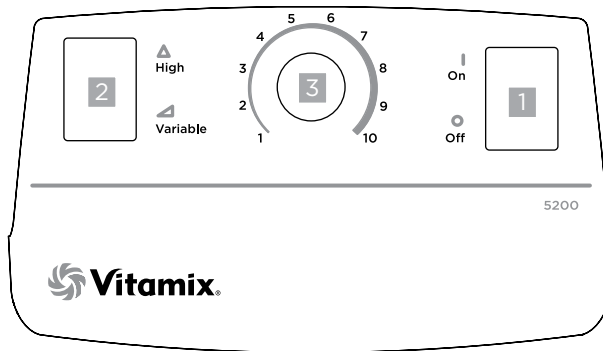

- 1. On/Off Switch:** Push up to turn On (I). Push down to turn Off (O).
- 2. High/Variable Switch:** High (Δ) is the fastest speed available. Switch to Variable (∟) to activate all of the lower variable speeds.  
  
Always make sure that the High/Variable Switch is set to Variable (∟) before pushing the On/Off Switch to the On (I) position. Do not start your machine on High (Δ) speed.
- 3. Variable Speed Dial:** Selects many speed settings. It is active only when the High/Variable Switch is set in the Variable (∟) position.



## HINTS FOR SETTING SPEEDS

Always start the machine with the left switch down in the Variable ( $\triangleleft$ ) position and with the center Variable Speed Dial on 1. Slowly turn the Variable Speed Dial to the desired speed depending on the recipe used. If a recipe calls for processing on High ( $\triangle$ ), slowly rotate the Variable Speed Dial to 10 and then push the High/Variable Switch up into the High ( $\triangle$ ) position. **Do not begin processing on Variable 10 or directly on the High ( $\triangle$ ) setting.**

Process on the High ( $\triangle$ ) setting for as much of the processing time as possible to make whole food juices, soups, shakes, frozen mixtures, purées, nut butters and for grinding grains. Processing times will generally be less than one minute (most take less than 30 seconds). High ( $\triangle$ ) speed provides the best quality of refinement, breaking down ice, frozen fruit, whole fruits or vegetables, and grains to a smooth lump-free consistency.

**TIP:** Blending too long at too low a speed setting will overheat the machine and cause the Automatic Overload Protection to turn the machine off. Use the High ( $\triangle$ ) speed as often as possible to achieve the most uniform consistency. Blending on High ( $\triangle$ ) speed also maximizes the motor's cooling fan to avoid overheating.

When on the High ( $\triangle$ ), if the food does not circulate, the machine may be overloaded or may have trapped an air bubble. Carefully remove the lid plug while making sure the lid stays firmly in place. Release the air bubble by inserting the tamper through the lid plug opening. If circulation problems continue, reduce the machine speed. A lower speed may allow food to circulate when a higher speed does not. Once the food is circulating freely, increase the speed back to High ( $\triangle$ ) and continue processing.



<b>⚠CAUTION</b>		
	<p><b>Never Start on Speeds Above 1 with Hot Liquids to Avoid Possible Burns.</b></p> <p>Use Caution; escaping steam or splashes may scald.</p> <p>Lock the lid. This will prevent expansion from affecting the position of the lid when the machine is turned on.</p> <p>Start on Variable 1, slowly increase to 10.</p>	

# OPERATING INSTRUCTIONS

## Wet Blade Container

Designed for processing liquids including juice, frozen mixtures, sauces, soups, purees, batters, and for wet chopping.

1. Make sure that the Variable Speed Dial is set to 1.
2. Load the container before placing it on the motor base. Place liquids and soft foods in the container first, solid items and ice last. Although not necessary for blending, you may want to cut or break food into smaller pieces for more precise measuring of ingredients.
3. Securely fasten the 2-part lid. Always use the complete 2-part lid when blending (unless the tamper is inserted through the lid plug opening). Especially when blending hot ingredients, make sure the lid is securely latched.
4. With the motor off, set the wet blade container on the motor base by aligning it over the centering pad. Do not ever attempt to put a container on an operating motor base or to operate a motor base without a container properly in place.
5. Start with the High/Variable Switch in the Variable (⚡) position. Always start your machine on variable speed 1. Activate the machine by turning the On/Off Switch to On (I) then slowly increase to the desired speed. Your container will shift and get into an aligned position.
6. **Take proper care when handling and processing hot ingredients and making hot soups and sauces.**

⚠ CAUTION		
	<p><b>Never Start on Speeds Above 1 with Hot Liquids to Avoid Possible Burns.</b></p> <p>Use Caution; escaping steam or splashes may scald.</p> <p>Lock the lid. This will prevent expansion from affecting the position of the lid when the machine is turned on.</p> <p>Start on Variable 1, slowly increase to 10.</p>	

7. Due to the machine's speed, processing times are much quicker than standard appliances. Until you are accustomed to the machine, count your time carefully to avoid over-processing.
8. After turning the machine off, wait until the blades completely stop before removing the lid or container from the motor base.

# OPERATING INSTRUCTIONS

## **Dry Blade Container**

If purchased, your dry blade container should only be used for hard, dry materials such as grain, and for kneading dough.

1. Make sure that the Variable Speed Dial is set to 1.
2. Securely fasten the 2-part lid. Always use the complete 2-part lid when blending (unless the tamper is inserted through the lid plug opening).
3. With the motor off, set the dry blade container on the motor base by aligning it over the centering pad. Do not ever attempt to put a container on an operating motor base or to operate a motor base without a container properly in place.
4. Start with the High/Variable Switch in the Variable () position. Always start your machine on variable speed 1. Activate the machine by turning the On/Off Switch to On (I) then slowly increase to the desired speed. Your container will shift and get into an aligned position.
5. After turning the machine off, wait until the blades completely stop before removing the lid or container from the motor base.
6. Due to the machine's speed, and the sometimes-short processing times, count your time carefully to avoid over-processing.
7. Grinding dry material for more than two minutes could damage your machine. Regular use may result in cosmetic marring of the container and cause the blades to become dull over time.
8. Grinding some herbs may release volatile oils, causing the container to discolor permanently. Others have strong odors that may linger in the container, affecting the flavor of other foods. The grinding of some herbs and spices may also cause the blade to dull over time, or the container to crack.

# CARE AND CLEANING

## Container

To prepare your new machine for initial use, follow the steps under Normal Cleaning below.

This will clean the unit, and break-in the motor.

### Normal Cleaning:

1. Fill the container half full with warm water and add a couple drops of liquid dish washing detergent to the container.
2. Snap or push the complete 2-part lid into locked position.
3. Select variable speed 1. Turn machine on and slowly increase speed to variable speed 10, then to High.
4. Run the machine on High speed for 30 to 60 seconds.
5. Turn off the machine, and rinse and drain the container.

### To Sanitize:

1. Follow Normal Cleaning instructions above.
2. Fill the container half full with water and 1 1/2 teaspoons of liquid bleach.
3. Snap or push the complete 2-part lid into locked position.
4. Select variable speed 1. Turn machine on and slowly increase speed to variable speed 10, then to High.
5. Run the machine on High speed for 30 to 60 seconds.
6. Turn off the machine, and allow mixture to stand in the container for an additional 1 1/2 minutes.
7. Pour bleach mixture out. Allow container to air dry.
8. Do not rinse after sanitizing.

## Lid And Lid Plug:

Separate the lid and lid plug. Wash in warm soapy water. Rinse clean under running water, and dry. Reassemble before use.

**IMPORTANT:** To ensure continued and effective performance, do not put the container, lid, or lid plug in the dishwasher.

### Motor Base:

1. Unplug the power cord.

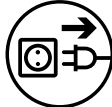
<b>⚠ WARNING</b>		
	<p><b>Electrical Shock Hazard.</b> Disconnect power before cleaning machine. <b>Failure to follow instructions can cause death or electrical shock.</b></p>	

2. Wash the outside surface with a damp soft cloth or sponge, which has been rinsed in a mild solution of liquid detergent and warm water. Do not place the motor base in water.
3. The centering pad can be removed for more thorough cleaning.
4. Thoroughly clean the switches so they work freely. They may become sticky from use. Use a moistened cotton swab to clean the grooves around the water-shielded switches. Immediately dry any excess water.
5. Polish with a soft cloth.

# TROUBLESHOOTING

## **Automatic Overload Protection**

**Your Vitamix machine is equipped with a special feature:** Automatic Overload Protection. This built-in feature is designed to protect the motor and prevent your machine from overheating. That means peace of mind for you as a Vitamix owner. When engaged, this Automatic Overload Protection will cause the motor to shut off and possibly emit a light odor.

If your Automatic Overload Protection should ever be activated, refer to page 7 in this manual to easily reset your machine.

### **Tips to prevent “overloading” your Vitamix machine:**

- Process only Vitamix recipes when learning to use the machine
- Do not process recipes at lower speeds than recommended
- Do not process recipes at higher speeds than recommended
- Do not process recipes longer than recommended
- Use your tamper to process thicker mixtures and keep ingredients moving around and through the blades

## **Retainer Nut Loosening**

In the event that the retainer nut at the bottom of your container loosens and no longer securely holds the blade assembly in place, **DO NOT CONTINUE TO USE THE CONTAINER**. Call Vitamix Customer Service at 1-800-848-2649 or 1-440-235-4840, or your local dealer immediately for instructions.

# WARRANTY

## 7-Year Full Machine Warranty

### 1. PRODUCT REGISTRATION.

Vita-Mix® Corporation (“Vitamix”) strongly encourages you to register your purchase by completing and returning the product registration card that came with this Machine. You can register online at [www.vitamix.com/warranty](http://www.vitamix.com/warranty); or by calling our Customer Service Department at 1-800-848-2649 or 1-440-235-4840. Failure to register your product purchase will not diminish your warranty rights. However, registering your purchase will allow Vitamix to better serve you with any of your customer service needs.

### 2. WHO CAN SEEK WARRANTY COVERAGE.

This Warranty is extended by Vitamix to the owner of this Machine for personal household use only. This Warranty does not apply to products used for commercial, rental or re-sale purposes. Should ownership of the machine change during the 7-year period, please update the Machine’s owner information at [www.vitamix.com/warranty](http://www.vitamix.com/warranty).

### 3. WHAT IS COVERED.

Vitamix warrants to the owner that if this Machine (***a “Machine” consists of a motor blender base and any containers purchased together***) fails within 7 years from the date of purchase due to a defect in material or workmanship or as a result of normal wear and tear from ordinary household use, Vitamix will, within 30 days of receipt of the returned product, repair the failed Machine or component part of the Machine free of charge.

If, in Vitamix’s sole discretion, the failed Machine or component part of the Machine cannot be repaired, Vitamix will elect to either (A) replace the Machine free of charge or (B) refund the full purchase price to the owner, unless Vitamix receives prior written notice of the owner’s preference.

### 4. WHAT IS NOT COVERED.

This Warranty does not apply to Machines that have been used commercially or in non-household applications. This Warranty does not cover cosmetic changes that do not affect performance, such as discoloration or the effects of the use of abrasives or cleaners or food build up. This Warranty is only valid if the Machine is used and maintained in accordance with the instructions, warnings and safeguards contained in the owner’s manual.

Vitamix will not be responsible for the cost of any unauthorized warranty repairs.

REPAIR, REPLACEMENT OR REFUND OF THE PURCHASE PRICE ARE THE EXCLUSIVE REMEDIES OF PURCHASER AND THE SOLE LIABILITY OF VITAMIX UNDER THIS WARRANTY. NO EMPLOYEE OR REPRESENTATIVE OF VITAMIX IS AUTHORIZED TO MAKE ANY ADDITIONAL WARRANTY OR ANY MODIFICATION TO THIS WARRANTY WHICH MAY BE BINDING UPON VITAMIX. ACCORDINGLY, PURCHASER SHOULD NOT RELY UPON ANY ADDITIONAL STATEMENTS MADE BY ANY EMPLOYEE OR REPRESENTATIVE OF VITAMIX. IN NO EVENT, WHETHER BASED ON CONTRACT, INDEMNITY, WARRANTY, TORT (INCLUDING NEGLIGENCE), STRICT LIABILITY OR OTHERWISE, SHALL VITAMIX BE LIABLE FOR ANY SPECIAL, INDIRECT, INCIDENTAL OR CONSEQUENTIAL DAMAGES, INCLUDING, WITHOUT LIMITATION, LOSS OF PROFIT OR REVENUE.

Some states do not allow limits on warranties. In such states, the above limitations may not apply to you. Outside the U.S.A. and Canada, other warranties may apply.



# WARRANTY

## 5. WHAT VOIDS THIS WARRANTY.

Abuse, misuse, negligent use, alteration of the Machine, exposure to abnormal or extreme conditions, or failure to follow the operating instructions will void this Warranty.

The Warranty is also void if repairs to the Machine or any component part of the Machine are performed by someone other than either Vitamix or an authorized Vitamix Service Provider or if any component part of a Machine subject to this Warranty is used in combination with a motor base or container that is not expressly authorized by Vitamix.

## 6. HOW TO OBTAIN RETURN AUTHORIZATION UNDER THIS WARRANTY.

In the event that the Machine or any component part of the Machine needs service or repair, please call Vitamix Customer Service at 1-800-848-2649 or 1-440-235-4840. You will be asked to provide a date of purchase and proof of purchase for any product that has not been registered with Vitamix. For product subject to this Warranty you will be provided with a return authorization number, up-to-date shipping instructions and a pre-paid return pick up label. Vitamix will pay standard shipping costs on the return of a Machine or component part for warranty service and repair and for return shipment of the product to you after the warranty repair or replacement. Purchaser is responsible for the costs of special shipping requests.

Within the U.S.A. and Canada, this Warranty is honored directly through the Vita-Mix® Corporation.

### **United States**

Vita-Mix® Corporation  
8615 Usher Road  
Cleveland, Ohio 44138-2199  
1-800-848-2649  
service@vitamix.com

### **Canada**

Vita-Mix® Corporation  
200-1701 Shepherd Street East  
Windsor, Ontario N8Y 4Y5  
1-800-848-2649  
service@vitamix.com

You will be deemed to have accepted the returned product “as is” upon delivery unless you notify Vitamix of any problem, including shipment damage, within 48 hours of delivery.

### **SPECIAL INTERNATIONAL INSTRUCTIONS**

If a machine was purchased within the U.S.A. or Canada, but is currently outside the U.S.A. or Canada, all shipping and resulting taxes and duties are at the owner’s expense.  
Call +1-440-235-4840 or email service@vitamix.com for more details.





# SPECIFICATIONS

## **Vitamix® 5200**

### **Motor:**

≈ 2 peak output horsepower motor

### **Electrical:**

120 V, 50/60 Hz, 11.5 A

Uses a U.S.A. three-prong grounded cord.

### **Dimensions:**

Height: 20.5 in. / 52 cm

Width: 7.25 in. / 18,42 cm

Depth: 8.75 in. / 22,35 cm

---

When applicable:



To see the complete line of Vitamix® products,  
visit **[vitamix.com](http://vitamix.com)**.



Vita-Mix® Corporation  
8615 Usher Road  
Cleveland, OH 44138-2103 U.S.A.  
1-800-848-2649 / 1-440-235-4840  
**[www.vitamix.com](http://www.vitamix.com)**